

# CR 120

CR 120



**REYNAERS**  
aluminium

**Edition** 11/2010 (based on 089.C43E.00)



## CR 120



### CR 120

- 1 Verandadak
- 2 Lichtstraat
- 3 Afdekprofielen
- 4 Draggers
- 5 Middensteun
- 6 Veranda corner
- 7 Dal
- 8 Nok
- 9 Dakraam

### CR 120

- 1 Toiture de veranda
- 2 Verriere
- 3 Porfiles de recouvrement
- 4 Chevron
- 5 Support Centrale
- 6 Coin de veranda
- 7 Noue
- 8 Faitiere
- 9 Tabatiere

### CR 120

- 1 Veranda roof
- 2 Skylight
- 3 Fixed elements
- 4 Opening elements
- 5 Central support
- 6 Veranda corner
- 7 Valley
- 8 Ridge
- 9 Attic window









































### CR 120

- 1 Verandadach
- 2 Lichtkuppel
- 3 Abdeckprofile
- 4 Dachsparren
- 5 Mittelstuetze
- 6 Wintergartenecke
- 7 Kehlk
- 8 First
- 9 Dachfenster







## CR 120



### 1 Verandadak / Toiture de veranda / Veranda roof / Verandadach

<p>5° &lt; <math>\alpha</math> &lt; 45°</p>  <p>CR 120 - 002</p>		<p>5° &lt; <math>\alpha</math> &lt; 45°</p>  <p>CR 120 - 006</p>		<p>5° &lt; <math>\alpha</math> &lt; 45°</p>  <p>CR 120 - 010</p>		<p>5° &lt; <math>\alpha</math> &lt; 45°</p>  <p>CR 120 - 012</p>	
<p>5° &lt; <math>\alpha</math> &lt; 45°</p>  <p>CR 120 - 014</p>		<p>5° &lt; <math>\alpha</math> &lt; 45°</p>  <p>CR 120 - 018</p>		<p>5° &lt; <math>\alpha</math> &lt; 45°</p>  <p>CR 120 - 020</p>		<p>5° &lt; <math>\alpha</math> &lt; 45°</p>  <p>CR 120 - 022</p>	
<p>5° &lt; <math>\alpha</math> &lt; 30°</p>  <p>CR 120 - 024</p>		<p>5° &lt; <math>\alpha</math> &lt; 45°</p>  <p>CR 120 - 026</p>		<p>5° &lt; <math>\alpha</math> &lt; 25°</p>  <p>CR 120 - 028</p>		<p>5° &lt; <math>\alpha</math> &lt; 25°</p>  <p>CR 120 - 030</p>	
<p>5° &lt; <math>\alpha</math> &lt; 45°</p>  <p>CR 120 - 040</p>		<p>5° &lt; <math>\alpha</math> &lt; 45°</p>  <p>CR 120 - 042</p>		<p>5° &lt; <math>\alpha</math> &lt; 45°</p>  <p>CR 120 - 044</p>		<p>5° &lt; <math>\alpha</math> &lt; 45°</p>  <p>CR 120 - 046</p>	
<p>5° &lt; <math>\alpha</math> &lt; 45°</p>  <p>CR 120 - 048</p>		<p>5° &lt; <math>\alpha</math> &lt; 45°</p>  <p>CR 120 - 050</p>		<p>5° &lt; <math>\alpha</math> &lt; 45°</p>  <p>CR 120 - 052</p>		<p>5° &lt; <math>\alpha</math> &lt; 45°</p>  <p>CR 120 - 054</p>	
<p>5° &lt; <math>\alpha</math> &lt; 45°</p>  <p>CR 120 - 045</p>		<p>5° &lt; <math>\alpha</math> &lt; 45°</p>  <p>CR 120 - 047</p>		<p>5° &lt; <math>\alpha</math> &lt; 45°</p>  <p>CR 120 - 049</p>		<p>5° &lt; <math>\alpha</math> &lt; 45°</p>  <p>CR 120 - 051</p>	
<p>5° &lt; <math>\alpha</math> &lt; 45°</p>  <p>CR 120 - 041</p>		<p>5° &lt; <math>\alpha</math> &lt; 45°</p>  <p>CR 120 - 043</p>		<p>5° &lt; <math>\alpha</math> &lt; 45°</p>  <p>CR 120 - 045</p>		<p>5° &lt; <math>\alpha</math> &lt; 45°</p>  <p>CR 120 - 047</p>	

### 2 Lichtstraat / Verriere / Skylight / Lichtkuppel

<p>5° &lt; <math>\alpha</math> &lt; 45°</p>  <p>CR 120 - 050</p>		<p>5° &lt; <math>\alpha</math> &lt; 45°</p>  <p>CR 120 - 052</p>		<p>5° &lt; <math>\alpha</math> &lt; 45°</p>  <p>CR 120 - 054</p>	
---	---	---	---	---	--



## CR 120



- 3 Afdekprofielen      Profiles de recouvrement  
Covering profiles    Abdeckprofile



CR 120 - 060



CR 120 - 062



- 4 Draggers              Chevron  
Rafter                  Dachsparren



CR 120 - 064



CR 120 - 068



CR 120 - 069

- 5 Middensteun         Support Centrale  
Central support      Mittelstuetze



CR 120 - 070

- 6 Verandahoek        Coin de veranda  
Veranda corner      Wintergartenecke



CR 120 - 074

- 7 Dal                    Noue  
Valley                  Kehlk



CR 120 - 078



- 8 Nok                    Faitiere  
Ridge                  First



CR 120 - 079



CR 120 - 081



- 9 Dakraam             Tabatiere  
Attic window        Dachfenster



CR 120 - 082



CR 120 - 084



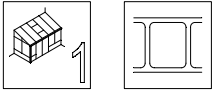

$5^\circ < \alpha < 30^\circ$  (007.0890.XX)

$30^\circ < \alpha < 45^\circ$  (007.0891.XX)

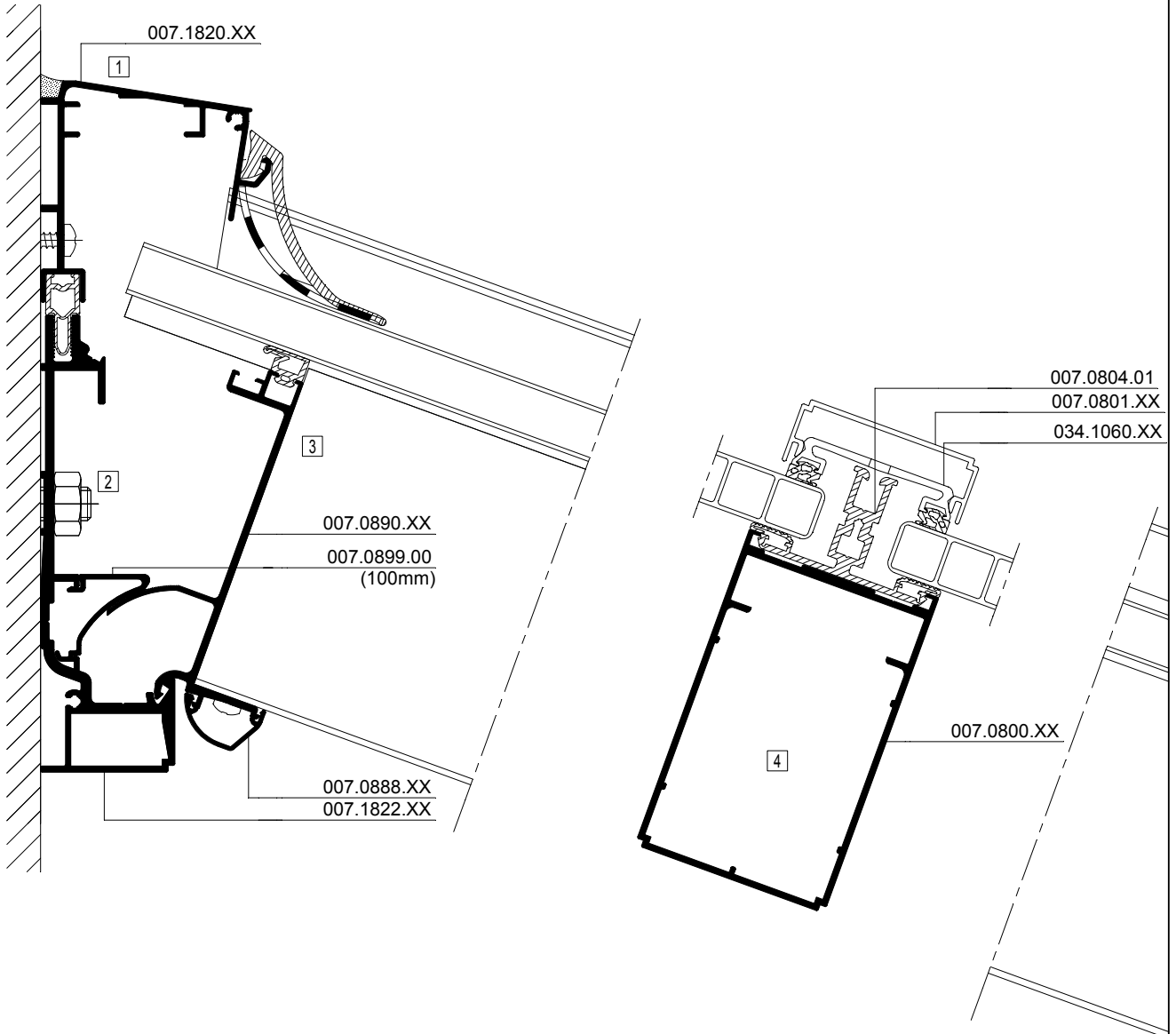

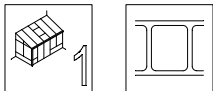

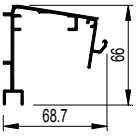
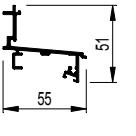
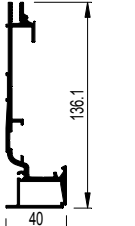
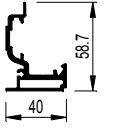
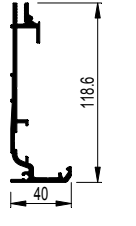
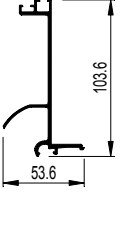
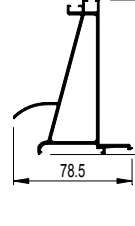
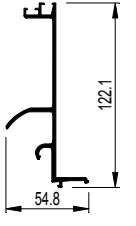
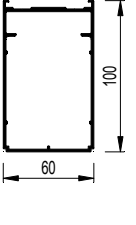
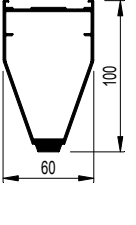
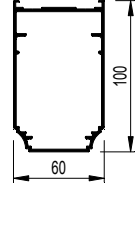
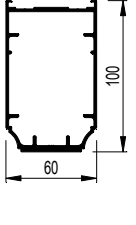
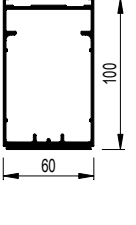
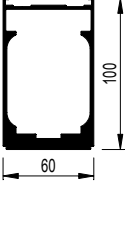
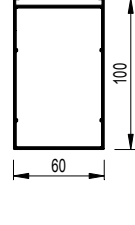
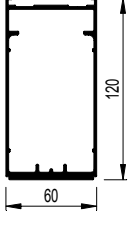
<p><b>007.1820.XX</b></p> <p>lx = 14.240 cm<sup>4</sup></p>  <p>1 CR120-001001.dxf CR120-001001.dwg</p>	<p><b>007.1821.XX</b></p> <p>lx = 4.193 cm<sup>4</sup></p>  <p>1 CR120-001002.dxf CR120-001002.dwg</p>	<p><b>007.1822.XX</b></p> <p>lx = 152.165 cm<sup>4</sup></p>  <p>2 CR120-002001.dxf CR120-002001.dwg</p>	<p><b>007.0823.XX</b></p> <p>lx = 6.316 cm<sup>4</sup></p>  <p>2 CR120-002002.dxf CR120-002002.dwg</p>
<p><b>007.0824.XX</b></p> <p>lx = 106.547 cm<sup>4</sup></p>  <p>2 CR120-002003.dxf CR120-002003.dwg</p>	<p><b>007.0890.XX</b></p> <p>lx = 46.235 cm<sup>4</sup></p>  <p>3 CR120-003001.dxf CR120-003001.dwg</p>	<p><b>007.0891.XX</b></p> <p>lx = 60.945 cm<sup>4</sup></p>  <p>3 CR120-003002.dxf CR120-003002.dwg</p>	<p><b>007.0859.XX</b></p> <p>lx = 71.409 cm<sup>4</sup></p>  <p>3 CR120-003003.dxf CR120-003003.dwg</p>
<p><b>007.0800.XX</b></p> <p>lx = 83.126 cm<sup>4</sup></p>  <p>4 CR120-004001.dxf CR120-004001.dwg</p>	<p><b>007.0810.XX</b></p> <p>lx = 83.820 cm<sup>4</sup></p>  <p>4 CR120-004002.dxf CR120-004002.dwg</p>	<p><b>007.0815.XX</b></p> <p>lx = 81.450 cm<sup>4</sup></p>  <p>4 CR120-004003.dxf CR120-004003.dwg</p>	<p><b>007.0814.XX</b></p> <p>lx = 102.598 cm<sup>4</sup></p>  <p>4 CR120-004004.dxf CR120-004004.dwg</p>
<p><b>007.0803.XX</b></p> <p>lx = 119.471 cm<sup>4</sup></p>  <p>4 CR120-004005.dxf CR120-004005.dwg</p>	<p><b>007.0813.XX</b></p> <p>lx = 151.075 cm<sup>4</sup></p>  <p>4 CR120-004006.dxf CR120-004006.dwg</p>	<p><b>007.0797.XX</b></p> <p>lx = 77.689 cm<sup>4</sup></p>  <p>4 CR120-004007.dxf CR120-004007.dwg</p>	<p><b>007.0798.XX</b></p> <p>lx = 186.767 cm<sup>4</sup></p>  <p>4 CR120-004008.dxf CR120-004008.dwg</p>

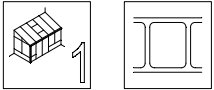

$5^\circ < \alpha < 30^\circ$  (007.0890.XX)

$30^\circ < \alpha < 45^\circ$  (007.0891.XX)

007.0880.XX

$I_x = 417.296 \text{ cm}^4$

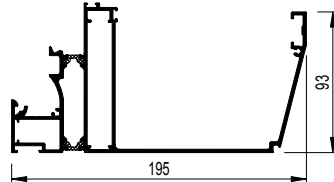

6 CR120-006001.dxf  
CR120-006001.dwg

007.0897.XX

$I_x = 622.134 \text{ cm}^4$

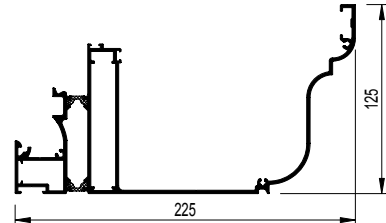

6 CR120-006002.dxf  
CR120-006002.dwg

007.0876.XX

$I_x = 456.212 \text{ cm}^4$

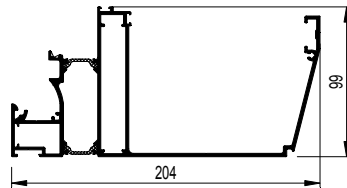

6 CR120-006006.dxf  
CR120-006006.dwg

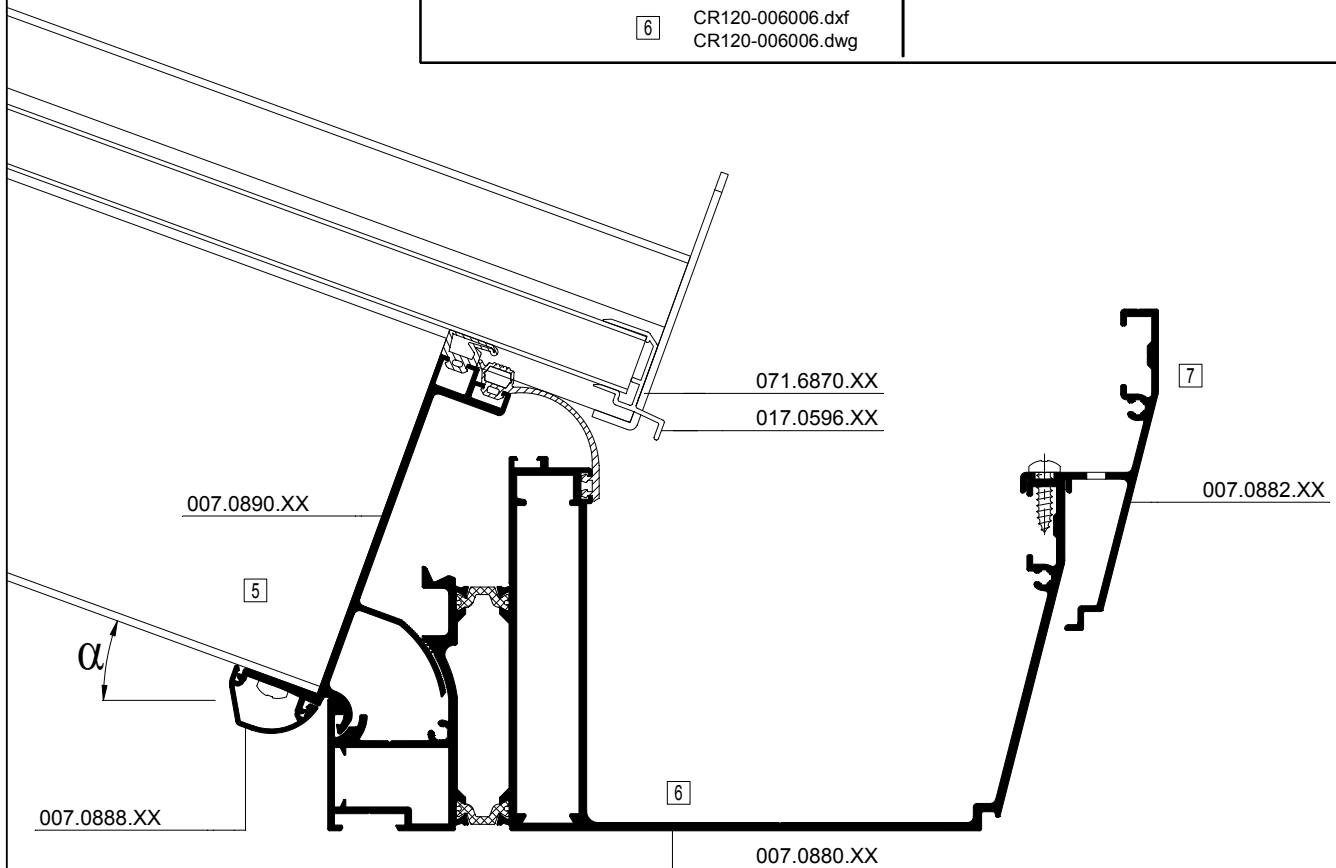



## 007.0878.XX + 017.0880.XX

$I_x = 345.117 \text{ cm}^4$

$I_x = 7.388 \text{ cm}^4$

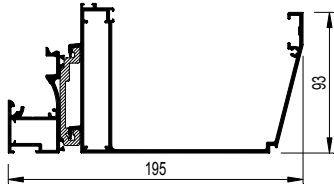

6 CR120-006003.dxf  
CR120-006003.dwg

## 007.0875.XX + 007.0872.XX

$I_x = 1610.268 \text{ cm}^4$

$I_x = 987.897 \text{ cm}^4$

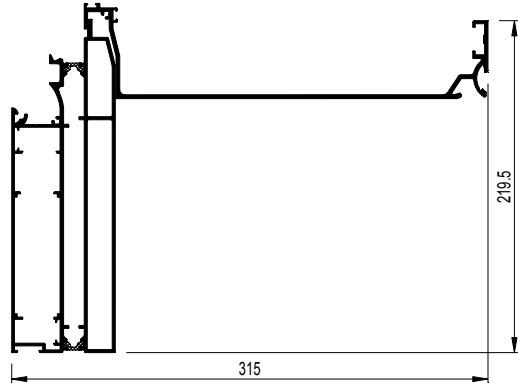

6 CR120-006005.dxf  
CR120-006005.dwg

## 007.0889.XX + 017.0880.XX

$I_x = 529.296 \text{ cm}^4$

$I_x = 7.388 \text{ cm}^4$

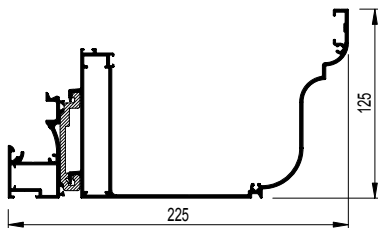

6 CR120-006004.dxf  
CR120-006004.dwg

## 007.0882.XX

$I_x = 2.425 \text{ cm}^4$

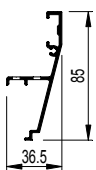

7 CR120-007001.dxf  
CR120-007001.dwg

## 007.0883.XX

$I_x = 13.167 \text{ cm}^4$

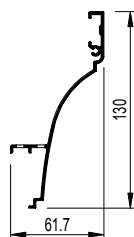

7 CR120-007002.dxf  
CR120-007002.dwg

## 007.0896.XX

$I_x = 3.081 \text{ cm}^4$

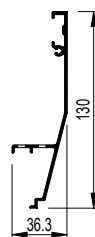

7 CR120-007003.dxf  
CR120-007003.dwg

## 007.0869.XX

$I_x = 13.992 \text{ cm}^4$

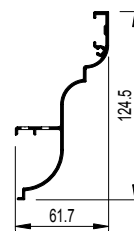

7 CR120-007004.dxf  
CR120-007004.dwg

## 007.0890.XX

$I_x = 46.235 \text{ cm}^4$

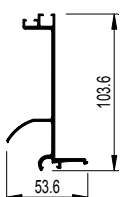

5 CR120-005001.dxf  
CR120-005001.dwg

## 007.0891.XX

$I_x = 60.945 \text{ cm}^4$

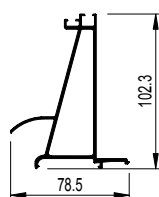

5 CR120-005002.dxf  
CR120-005002.dwg

## 007.0859.XX

$I_x = 71.409 \text{ cm}^4$

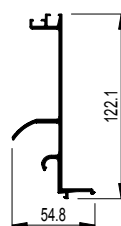

5 CR120-005003.dxf  
CR120-005003.dwg

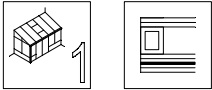

$5^\circ < \alpha < 28^\circ$  (007.0890.XX)

$28^\circ < \alpha < 45^\circ$  (007.0891.XX)

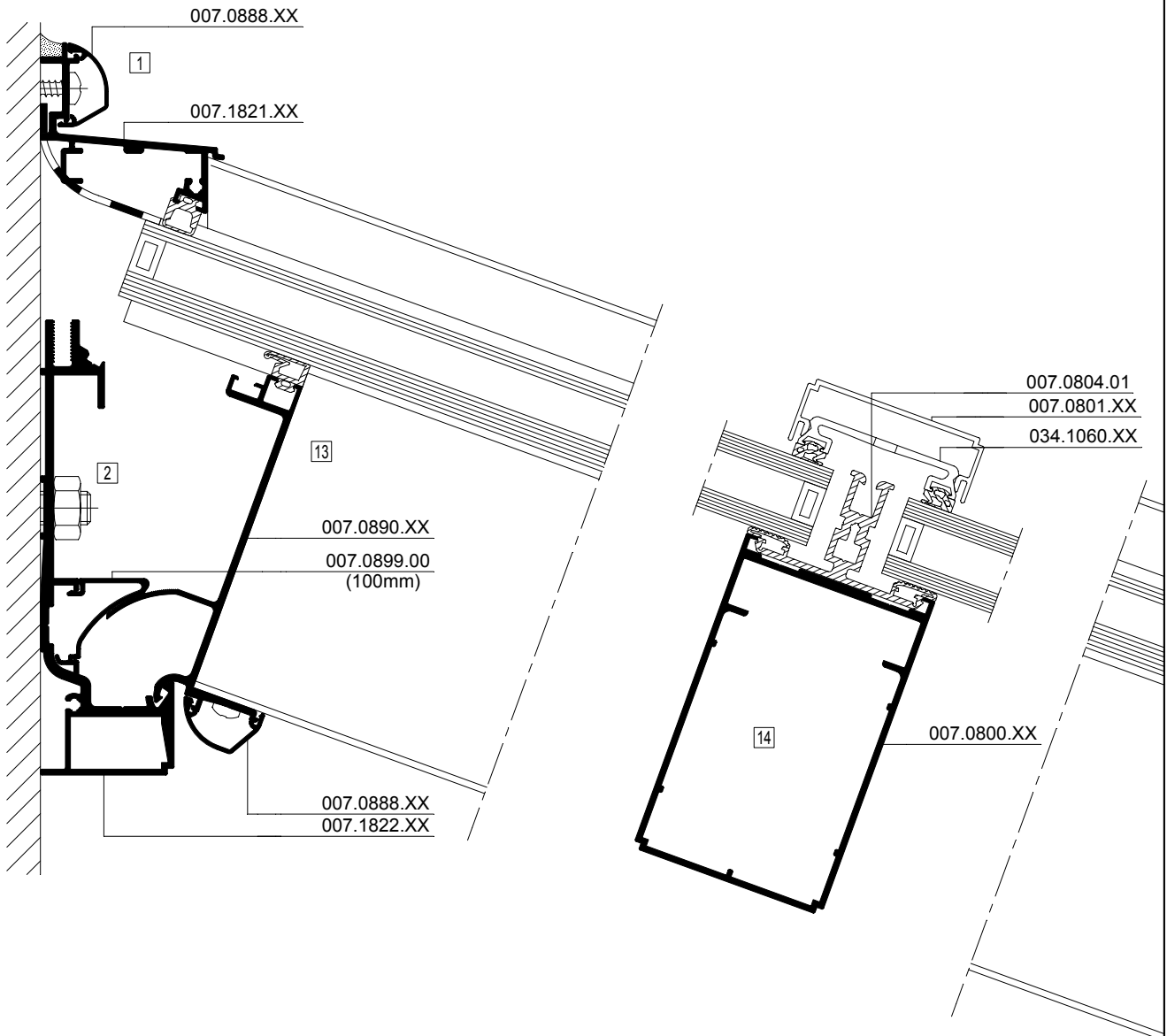

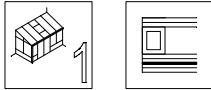

<p><b>007.0890.XX</b></p> <p><math>I_x = 46.235 \text{ cm}^4</math></p> <p>[13] CR120-013001.dxf CR120-013001.dwg</p>	<p><b>007.0891.XX</b></p> <p><math>I_x = 60.945 \text{ cm}^4</math></p> <p>[13] CR120-013002.dxf CR120-013002.dwg</p>	<p><b>007.0859.XX</b></p> <p><math>I_x = 71.409 \text{ cm}^4</math></p> <p>[13] CR120-013003.dxf CR120-013003.dwg</p>	
<p><b>007.0800.XX</b></p> <p><math>I_x = 83.126 \text{ cm}^4</math></p> <p>[14] CR120-014001.dxf CR120-014001.dwg</p>	<p><b>007.0810.XX</b></p> <p><math>I_x = 83.820 \text{ cm}^4</math></p> <p>[14] CR120-014002.dxf CR120-014002.dwg</p>	<p><b>007.0815.XX</b></p> <p><math>I_x = 81.450 \text{ cm}^4</math></p> <p>[14] CR120-014003.dxf CR120-014003.dwg</p>	<p><b>007.0814.XX</b></p> <p><math>I_x = 102.598 \text{ cm}^4</math></p> <p>[14] CR120-014004.dxf CR120-014004.dwg</p>
<p><b>007.0803.XX</b></p> <p><math>I_x = 119.471 \text{ cm}^4</math></p> <p>[14] CR120-014005.dxf CR120-014005.dwg</p>	<p><b>007.0813.XX</b></p> <p><math>I_x = 151.075 \text{ cm}^4</math></p> <p>[14] CR120-014006.dxf CR120-014006.dwg</p>	<p><b>007.0797.XX</b></p> <p><math>I_x = 77.689 \text{ cm}^4</math></p> <p>[14] CR120-014007.dxf CR120-014007.dwg</p>	<p><b>007.0798.XX</b></p> <p><math>I_x = 186.767 \text{ cm}^4</math></p> <p>[14] CR120-014008.dxf CR120-014008.dwg</p>

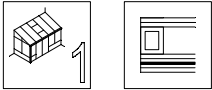

$5^\circ < \alpha < 28^\circ$  (007.0890.XX)

$28^\circ < \alpha < 45^\circ$  (007.0891.XX)

007.0880.XX

$I_x = 417.296 \text{ cm}^4$

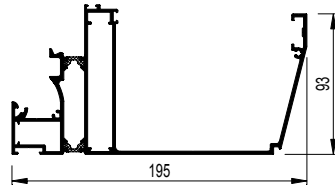

16 CR120-016001.dxf  
CR120-016001.dwg

007.0897.XX

$I_x = 622.134 \text{ cm}^4$

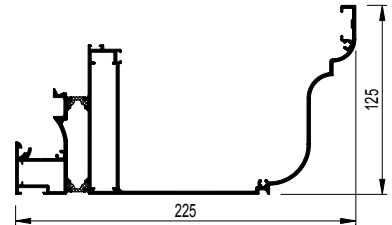

16 CR120-016002.dxf  
CR120-016002.dwg

007.0876.XX

$I_x = 456.212 \text{ cm}^4$

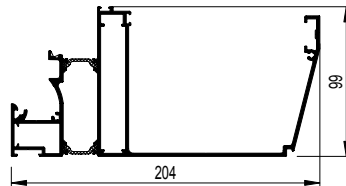

16 CR120-016006.dxf  
CR120-016006.dwg

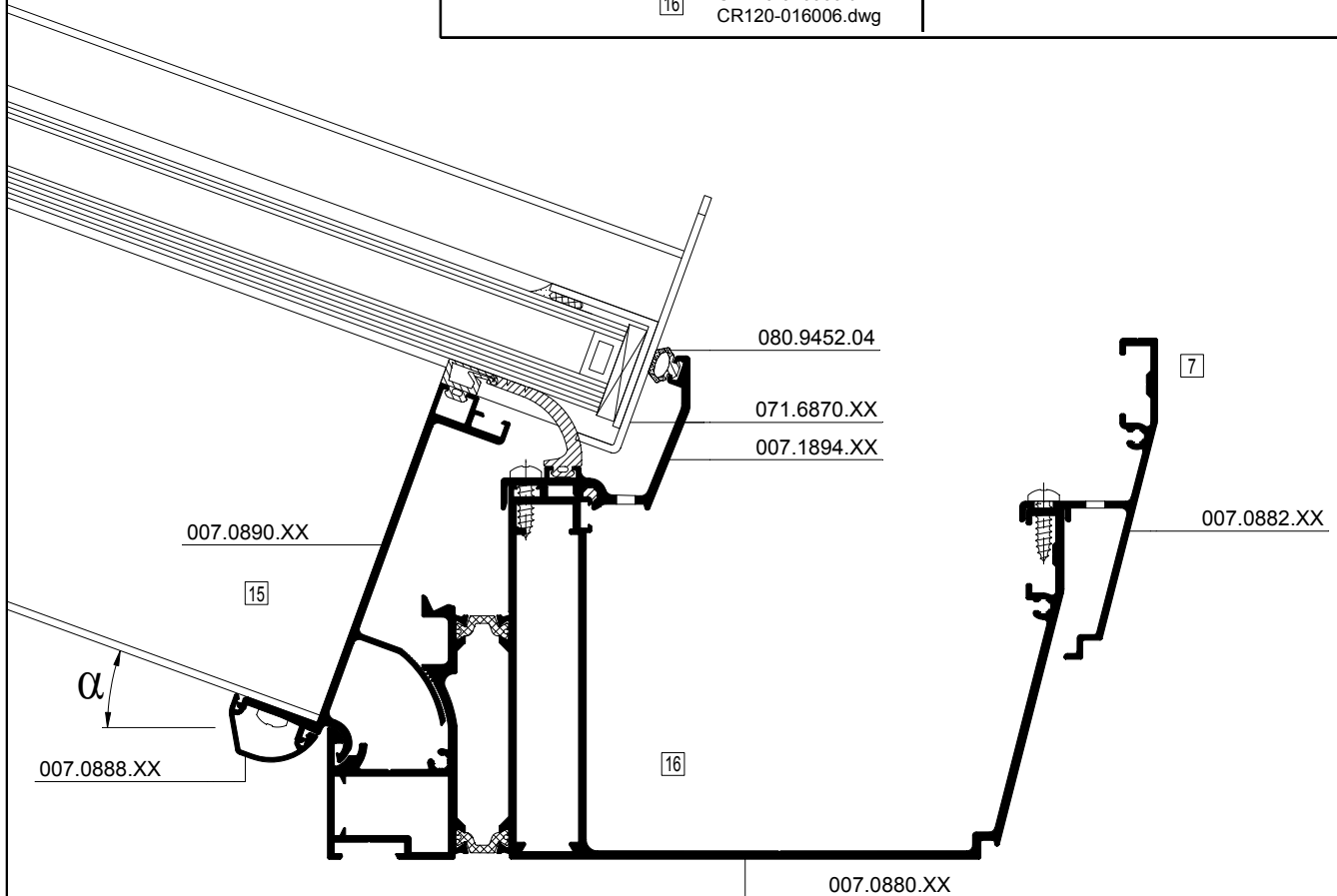





## 007.0878.XX + 017.0880.XX

$I_x = 345.117 \text{ cm}^4$

$I_x = 7.388 \text{ cm}^4$

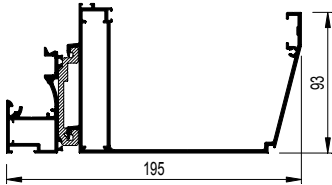

16

CR120-016003.dxf  
CR120-016003.dwg

## 007.0875.XX + 007.0872.XX

$I_x = 1610.268 \text{ cm}^4$

$I_x = 987.897 \text{ cm}^4$

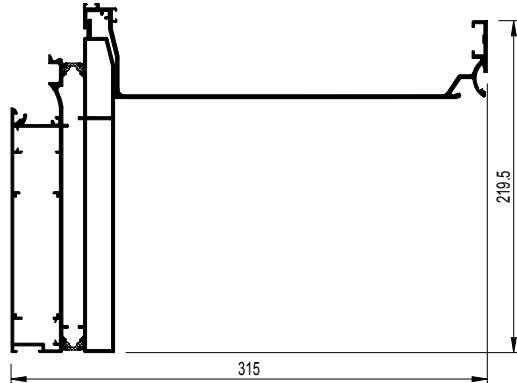

16

CR120-016005.dxf  
CR120-016005.dwg

## 007.0889.XX + 017.0880.XX

$I_x = 529.296 \text{ cm}^4$

$I_x = 7.388 \text{ cm}^4$

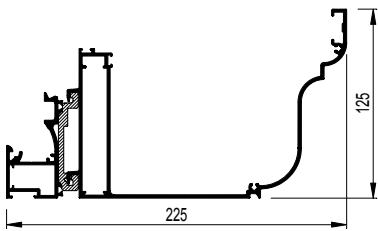

16

CR120-016004.dxf  
CR120-016004.dwg

## 007.0890.XX

$I_x = 46.235 \text{ cm}^4$

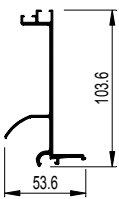

15

CR120-015001.dxf  
CR120-015001.dwg

## 007.0891.XX

$I_x = 60.945 \text{ cm}^4$

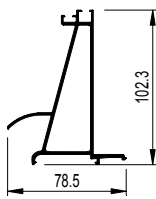

15

CR120-015002.dxf  
CR120-015002.dwg

## 007.0859.XX

$I_x = 71.409 \text{ cm}^4$

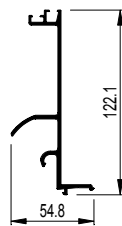

15

CR120-015003.dxf  
CR120-015003.dwg



$5^\circ < \alpha < 28^\circ$  (007.0892.XX)

$28^\circ < \alpha < 45^\circ$  (007.0893.XX)

007.1822.XX

$I_x = 152.165 \text{ cm}^4$

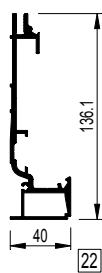

CR120-022001.dxf  
CR120-022001.dwg

007.0823.XX

$I_x = 6.316 \text{ cm}^4$

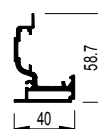

CR120-022002.dxf  
CR120-022002.dwg

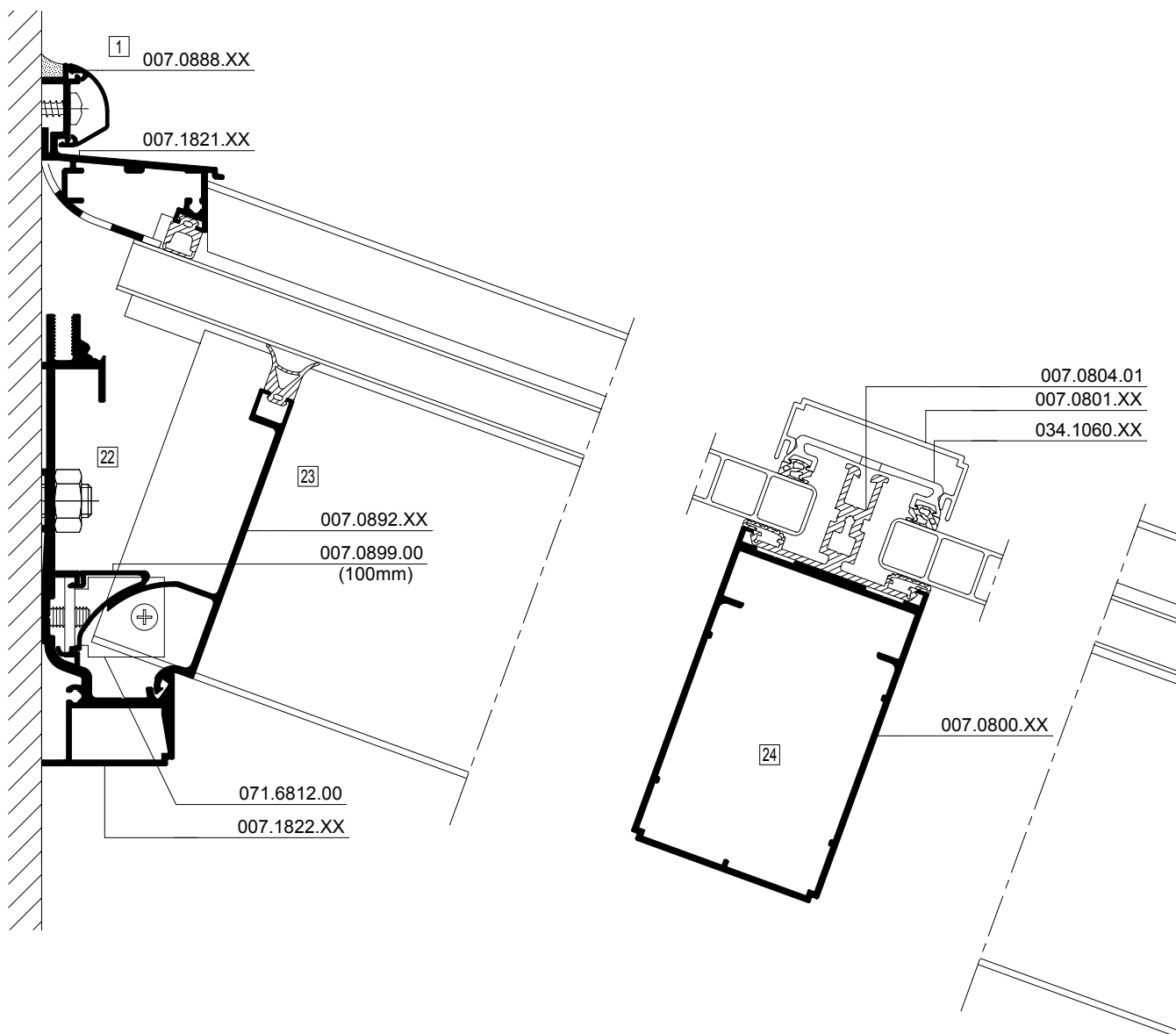

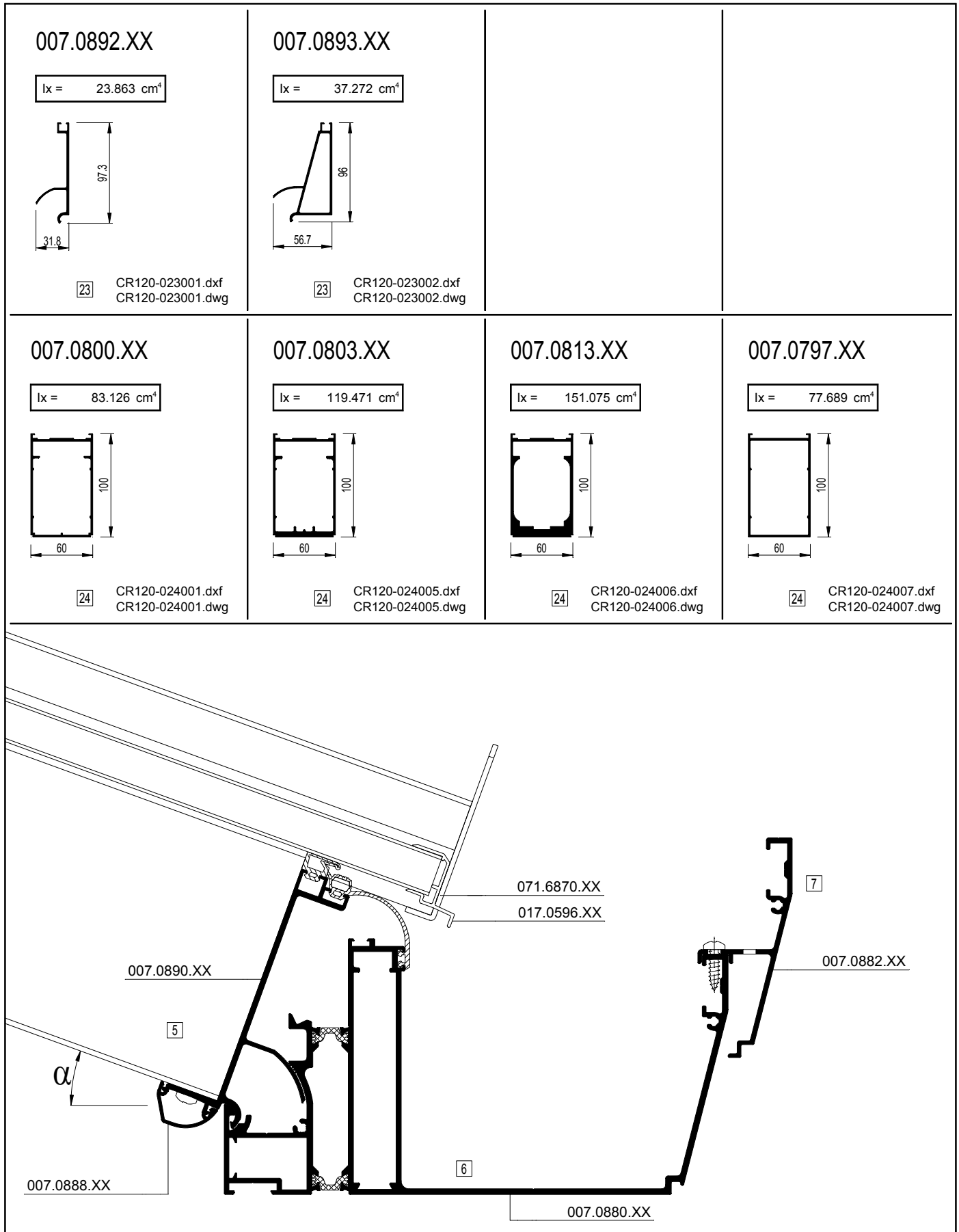



$5^\circ < \alpha < 28^\circ$  (007.0892.XX)

$28^\circ < \alpha < 45^\circ$  (007.0893.XX)

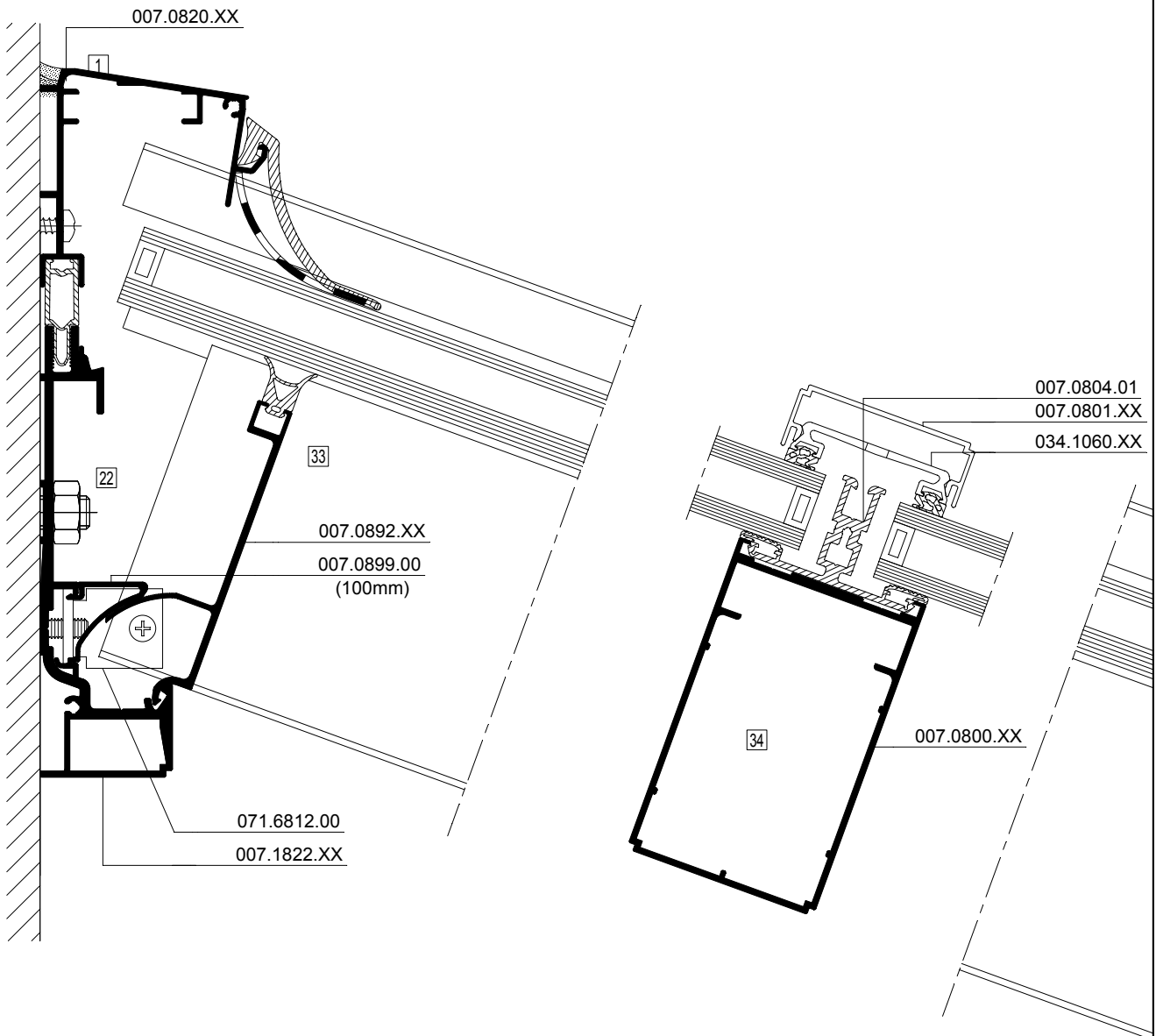

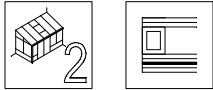

<p><b>007.0892.XX</b></p> <p>lx = 23.863 cm<sup>4</sup></p> <p><span>33</span> CR120-033001.dxf CR120-033001.dwg</p>	<p><b>007.0893.XX</b></p> <p>lx = 37.272 cm<sup>4</sup></p> <p><span>33</span> CR120-033002.dxf CR120-033002.dwg</p>		
<p><b>007.0800.XX</b></p> <p>lx = 83.126 cm<sup>4</sup></p> <p><span>34</span> CR120-034001.dxf CR120-034001.dwg</p>	<p><b>007.0803.XX</b></p> <p>lx = 119.471 cm<sup>4</sup></p> <p><span>34</span> CR120-034005.dxf CR120-034005.dwg</p>	<p><b>007.0813.XX</b></p> <p>lx = 151.075 cm<sup>4</sup></p> <p><span>34</span> CR120-034006.dxf CR120-034006.dwg</p>	<p><b>007.0797.XX</b></p> <p>lx = 77.689 cm<sup>4</sup></p> <p><span>34</span> CR120-034007.dxf CR120-034007.dwg</p>

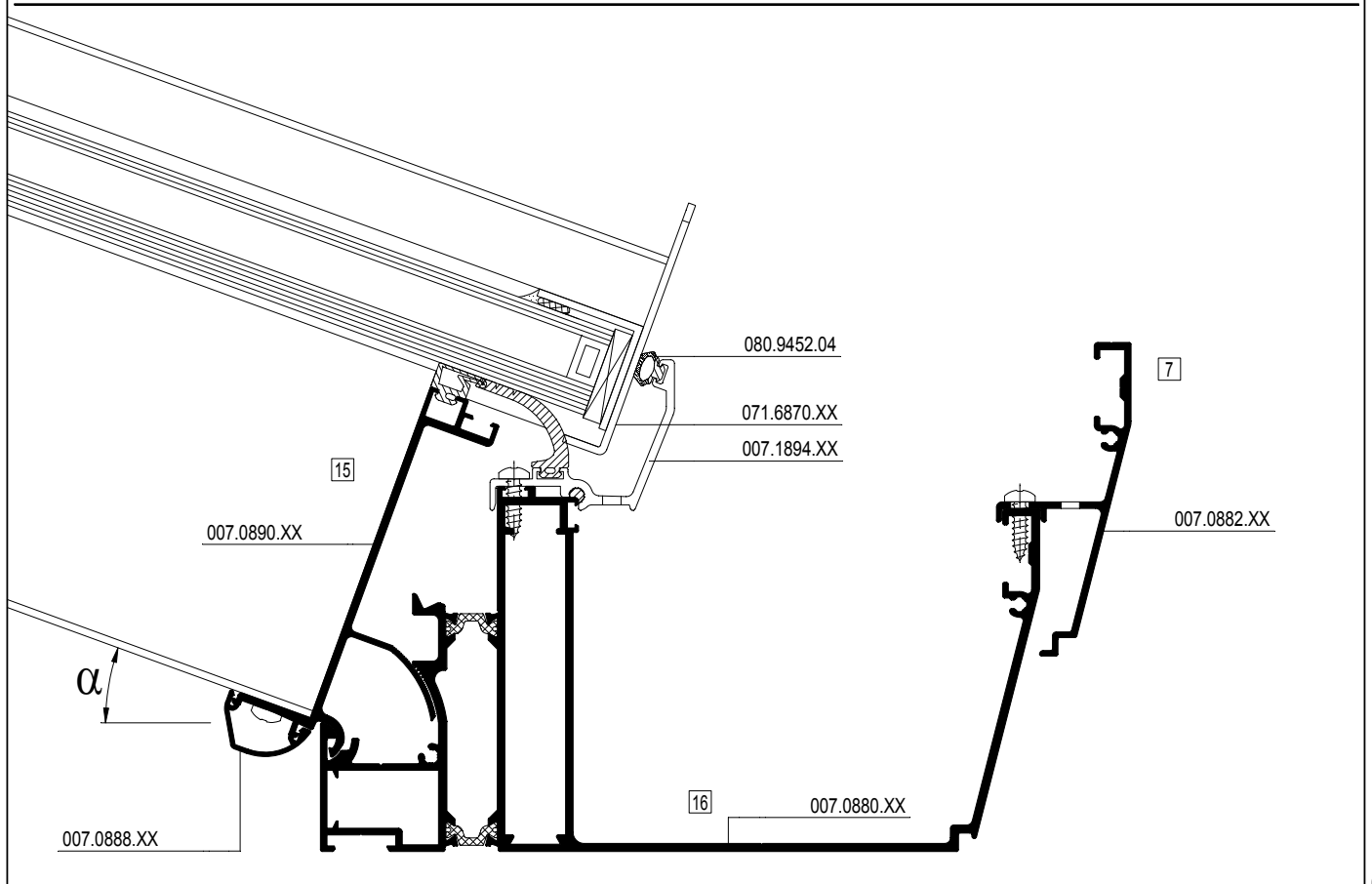



$5^\circ < \alpha < 25^\circ$  (007.0892.XX)

$25^\circ < \alpha < 45^\circ$  (007.0893.XX)

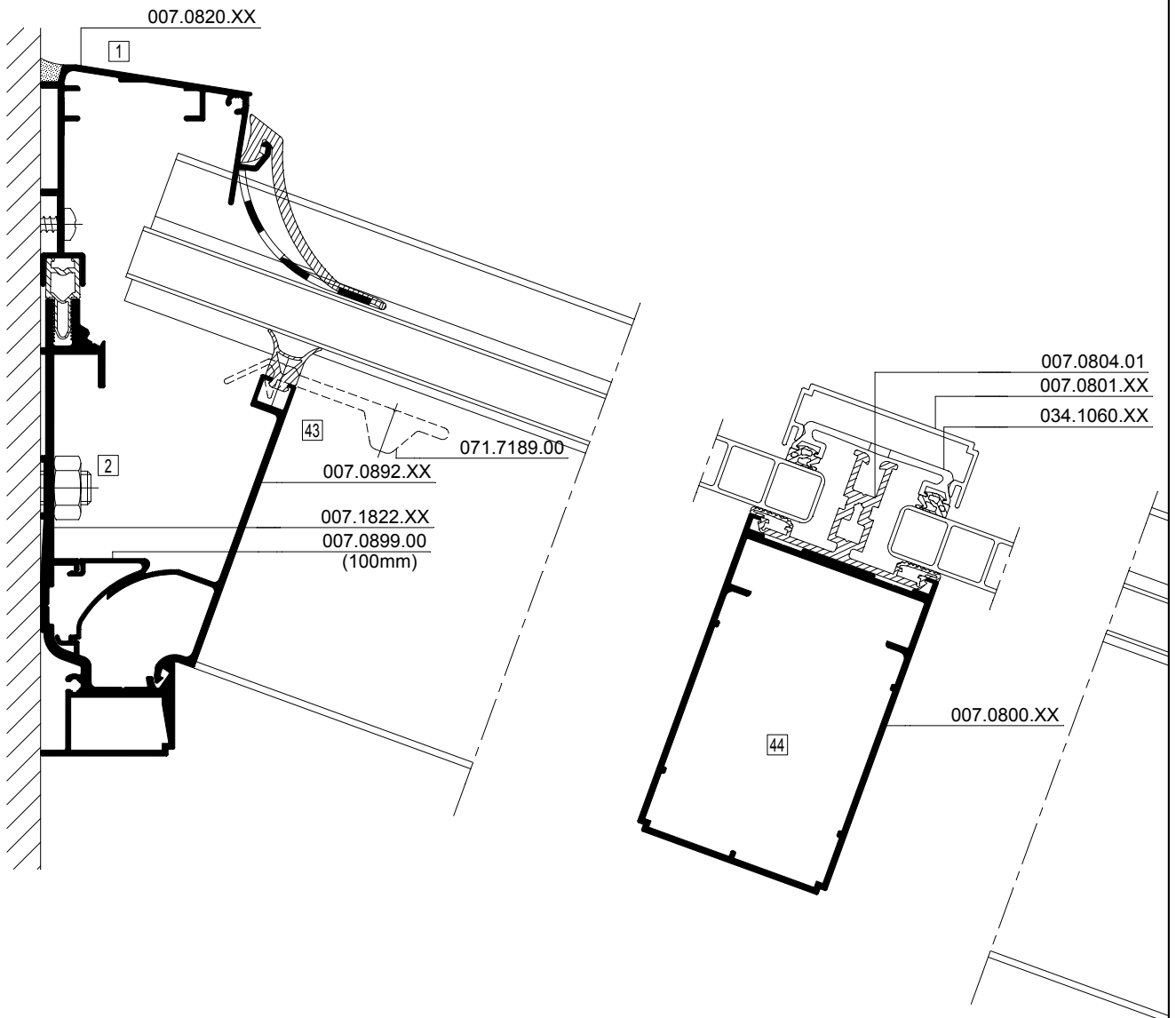

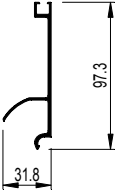
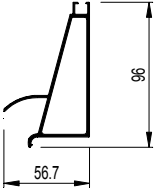
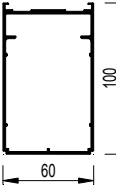
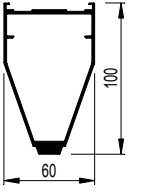
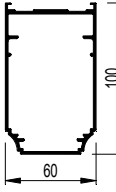
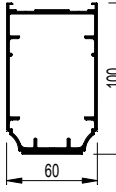
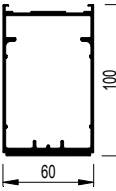
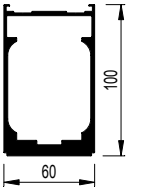
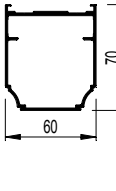
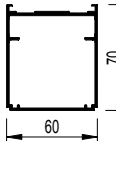
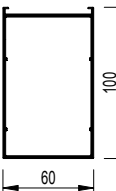

<p><b>007.0892.XX</b></p> <p><math>I_x = 23.863 \text{ cm}^4</math></p>  <p><span>43</span> CR120-043001.dxf CR120-043001.dwg</p>	<p><b>007.0893.XX</b></p> <p><math>I_x = 37.272 \text{ cm}^4</math></p>  <p><span>43</span> CR120-043002.dxf CR120-043002.dwg</p>		
<p><b>007.0800.XX</b></p> <p><math>I_x = 83.126 \text{ cm}^4</math></p>  <p><span>44</span> CR120-044001.dxf CR120-044001.dwg</p>	<p><b>007.0810.XX</b></p> <p><math>I_x = 83.820 \text{ cm}^4</math></p>  <p><span>44</span> CR120-044002.dxf CR120-044002.dwg</p>	<p><b>007.0815.XX</b></p> <p><math>I_x = 81.450 \text{ cm}^4</math></p>  <p><span>44</span> CR120-044003.dxf CR120-044003.dwg</p>	<p><b>007.0814.XX</b></p> <p><math>I_x = 102.598 \text{ cm}^4</math></p>  <p><span>44</span> CR120-044004.dxf CR120-044004.dwg</p>
<p><b>007.0803.XX</b></p> <p><math>I_x = 119.471 \text{ cm}^4</math></p>  <p><span>44</span> CR120-044005.dxf CR120-044005.dwg</p>	<p><b>007.0813.XX</b></p> <p><math>I_x = 151.075 \text{ cm}^4</math></p>  <p><span>44</span> CR120-044006.dxf CR120-044006.dwg</p>	<p><b>007.0817.XX</b></p> <p><math>I_x = 29.659 \text{ cm}^4</math></p>  <p><span>44</span> CR120-044007.dxf CR120-044007.dwg</p>	<p><b>007.0802.XX</b></p> <p><math>I_x = 32.169 \text{ cm}^4</math></p>  <p><span>44</span> CR120-044008.dxf CR120-044009.dwg</p>
<p><b>007.0797.XX</b></p> <p><math>I_x = 77.689 \text{ cm}^4</math></p>  <p><span>44</span> CR120-044009.dxf CR120-044009.dwg</p>			



$5^\circ < \alpha < 25^\circ$  (007.0892.XX)

$25^\circ < \alpha < 45^\circ$  (007.0893.XX)

007.0880.XX

$I_x = 417.296 \text{ cm}^4$

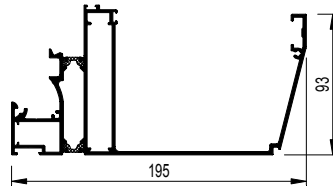

46 CR120-046001.dxf  
CR120-046001.dwg

007.0897.XX

$I_x = 622.134 \text{ cm}^4$

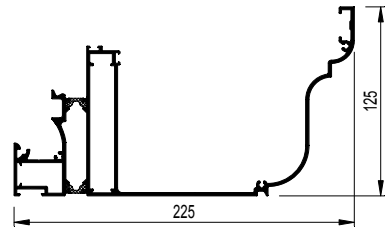

46 CR120-046002.dxf  
CR120-046002.dwg

007.0876.XX

$I_x = 456.212 \text{ cm}^4$

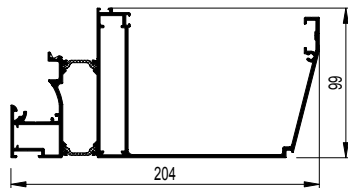

46 CR120-046006.dxf  
CR120-046006.dwg

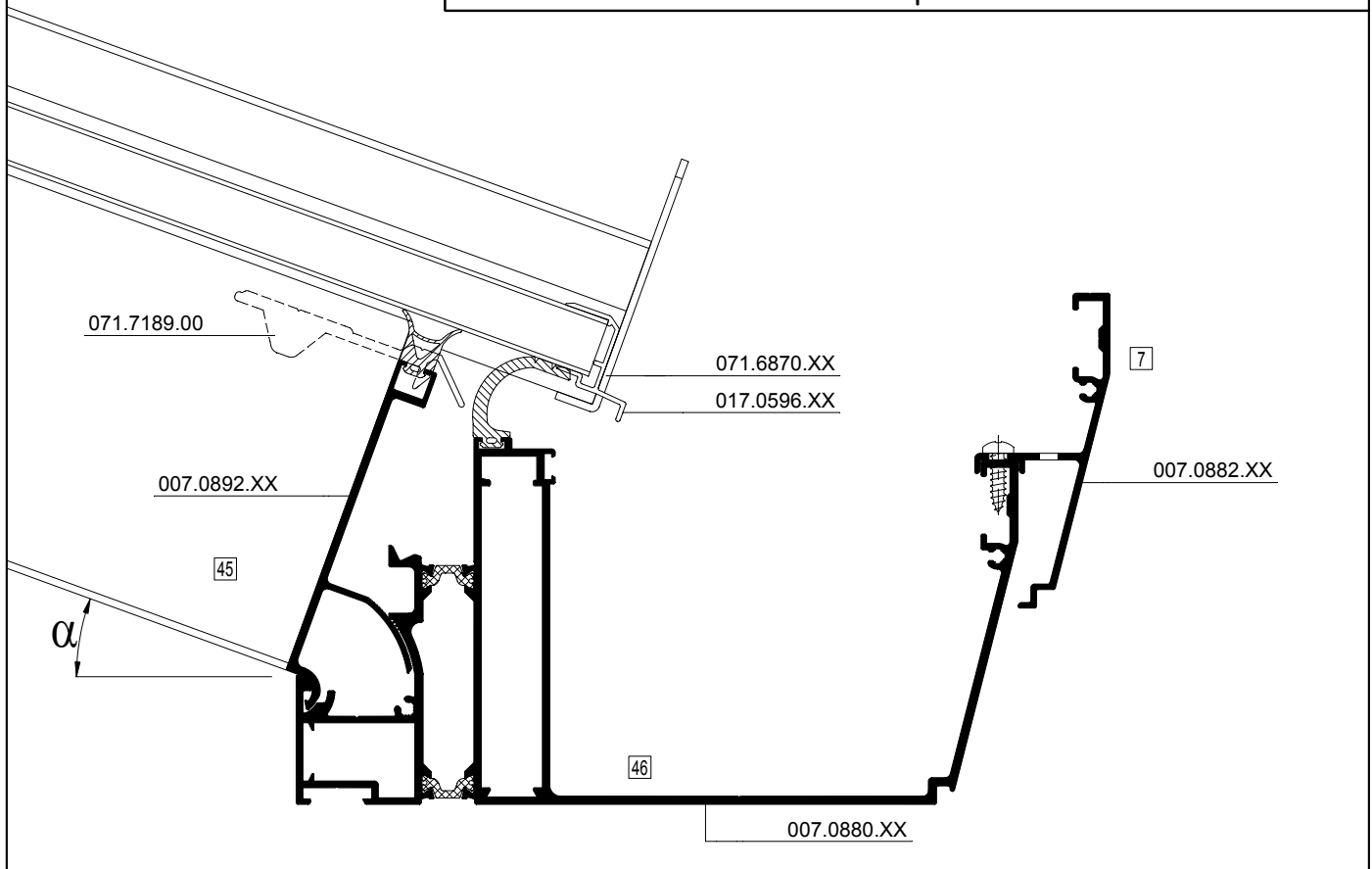





## 007.0878.XX + 017.0880.XX

$I_x = 345.117 \text{ cm}^4$

$I_x = 7.388 \text{ cm}^4$

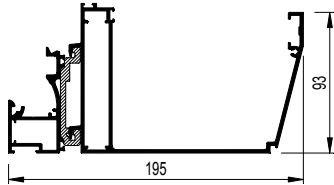

46 CR120-046003.dxf  
CR120-046003.dwg

## 007.0875.XX + 007.0872.XX

$I_x = 1610.268 \text{ cm}^4$

$I_x = 987.897 \text{ cm}^4$

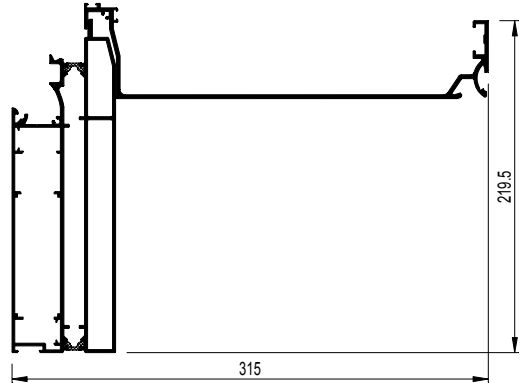

46 CR120-046005.dxf  
CR120-046005.dwg

## 007.0889.XX + 017.0880.XX

$I_x = 529.296 \text{ cm}^4$

$I_x = 7.388 \text{ cm}^4$

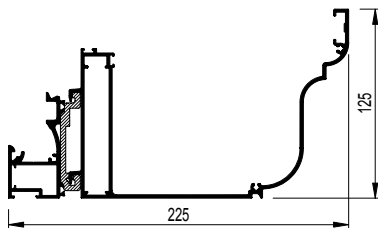

46 CR120-046004.dxf  
CR120-046004.dwg

## 007.0892.XX

$I_x = 23.863 \text{ cm}^4$

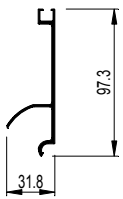

45 CR120-045001.dxf  
CR120-045001.dwg

## 007.0893.XX

$I_x = 37.272 \text{ cm}^4$

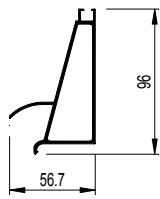

45 CR120-045002.dxf  
CR120-045002.dwg



$5^\circ < \alpha < 25^\circ$  (007.0892.XX)

$25^\circ < \alpha < 45^\circ$  (007.0893.XX)

007.0892.XX

$I_x = 23.863 \text{ cm}^4$

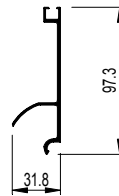

53

CR120-053001.dxf  
CR120-053001.dwg  
CR120-055001.dxf  
CR120-055001.dwg

55

007.0893.XX

$I_x = 37.272 \text{ cm}^4$

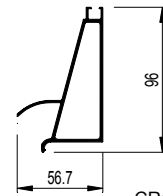

53

CR120-053002.dxf  
CR120-053002.dwg  
CR120-055002.dxf  
CR120-055002.dwg

55

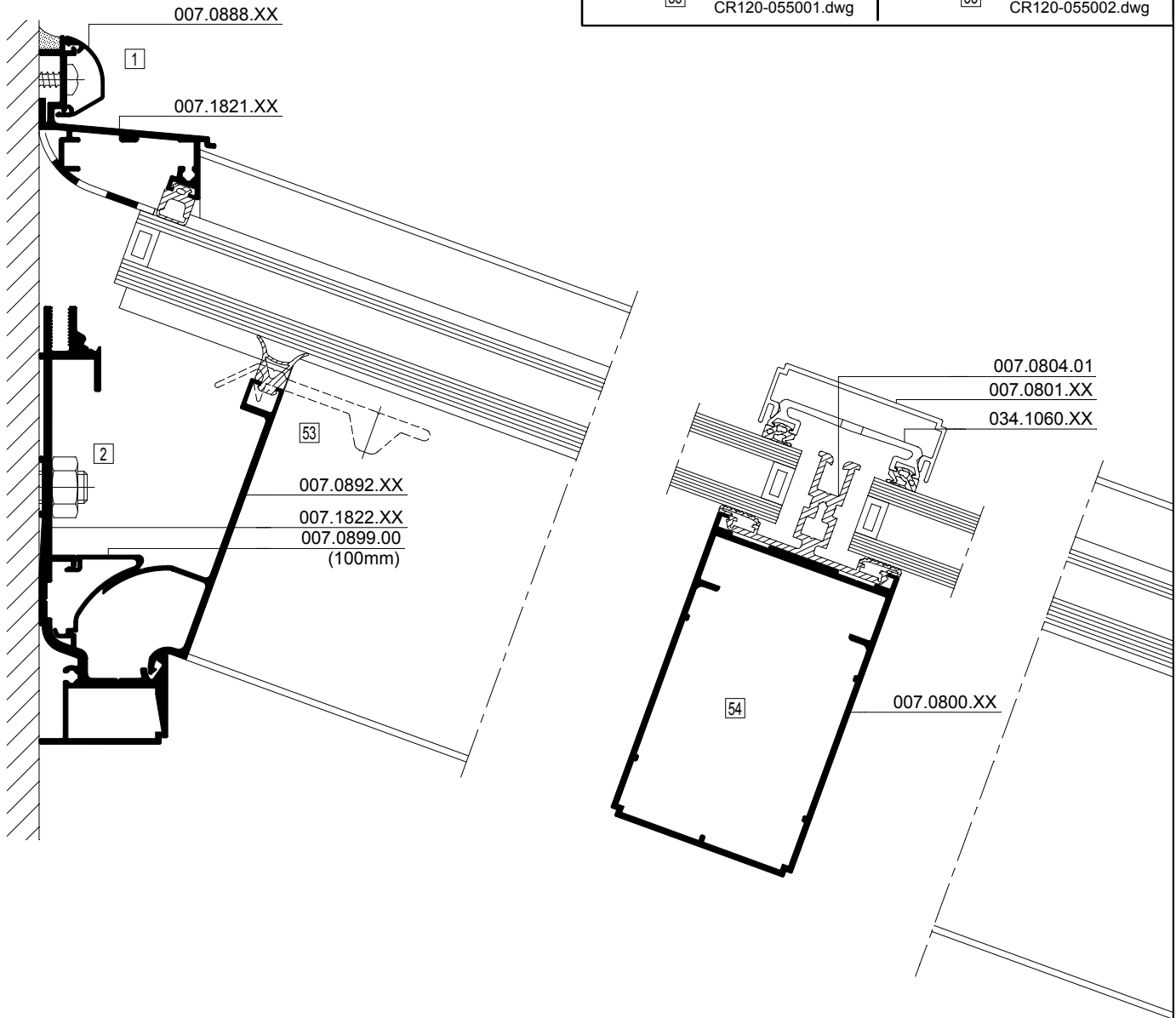

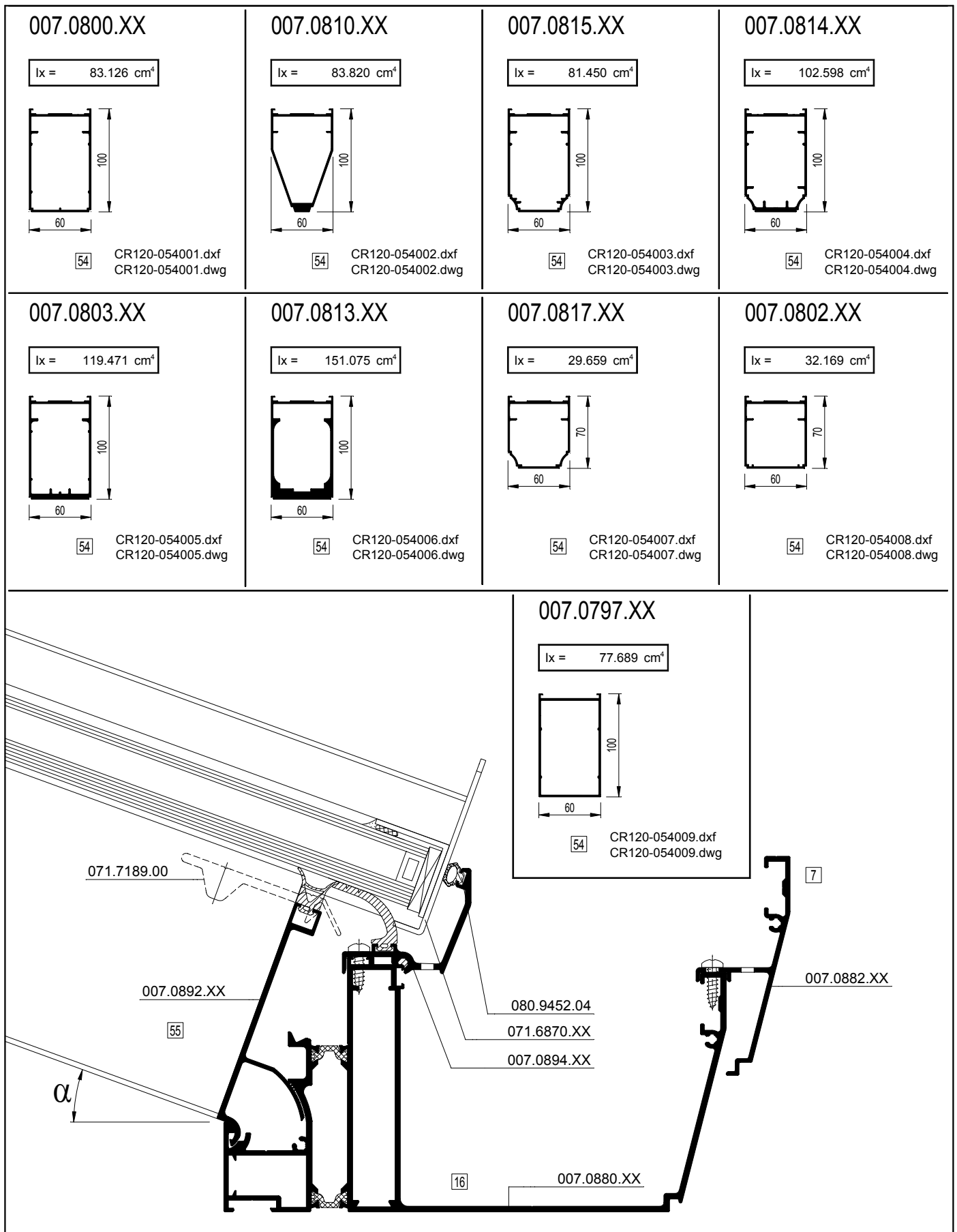



$5^\circ < \alpha < 25^\circ$  (007.0892.XX)

$25^\circ < \alpha < 45^\circ$  (007.0893.XX)

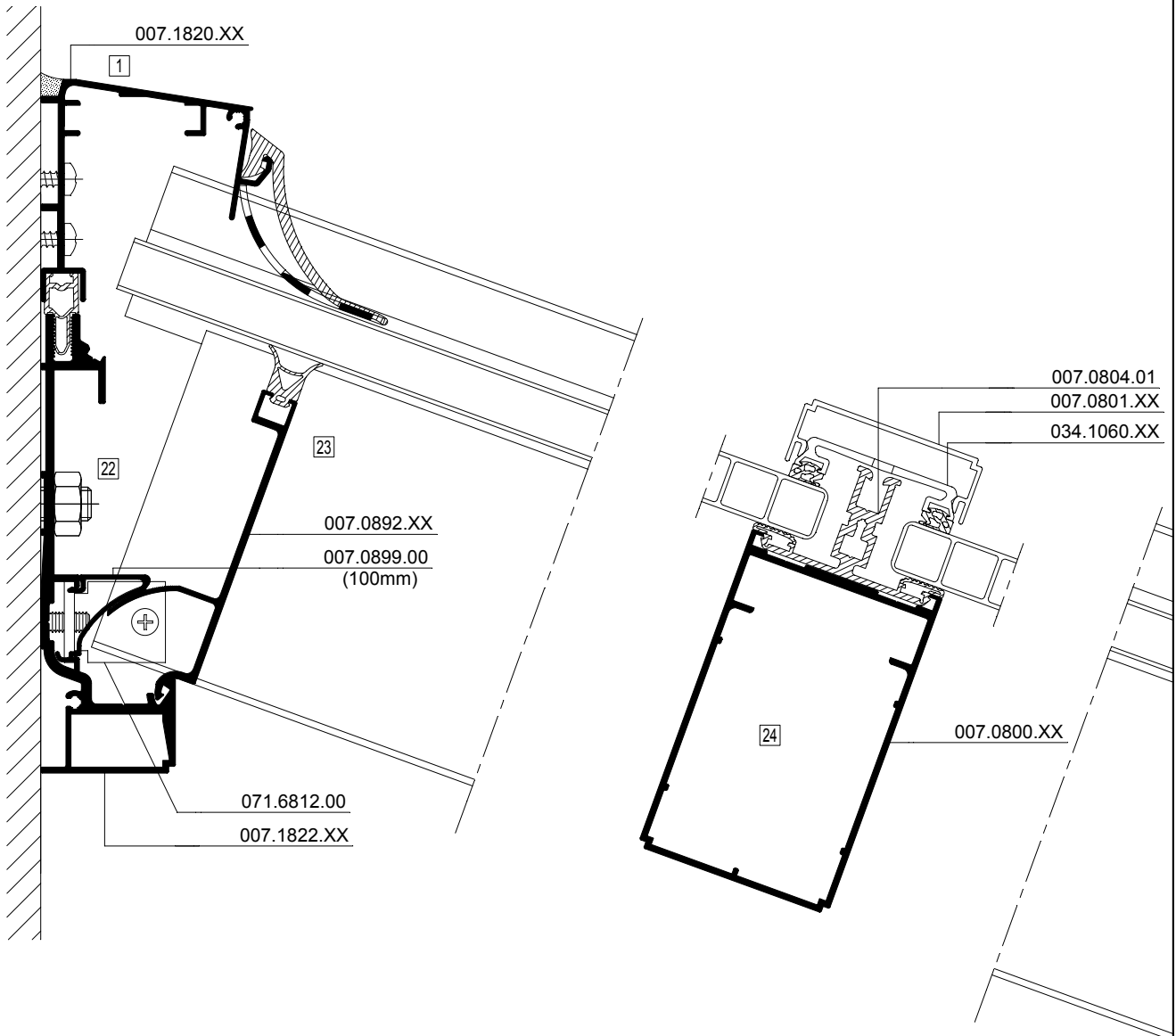

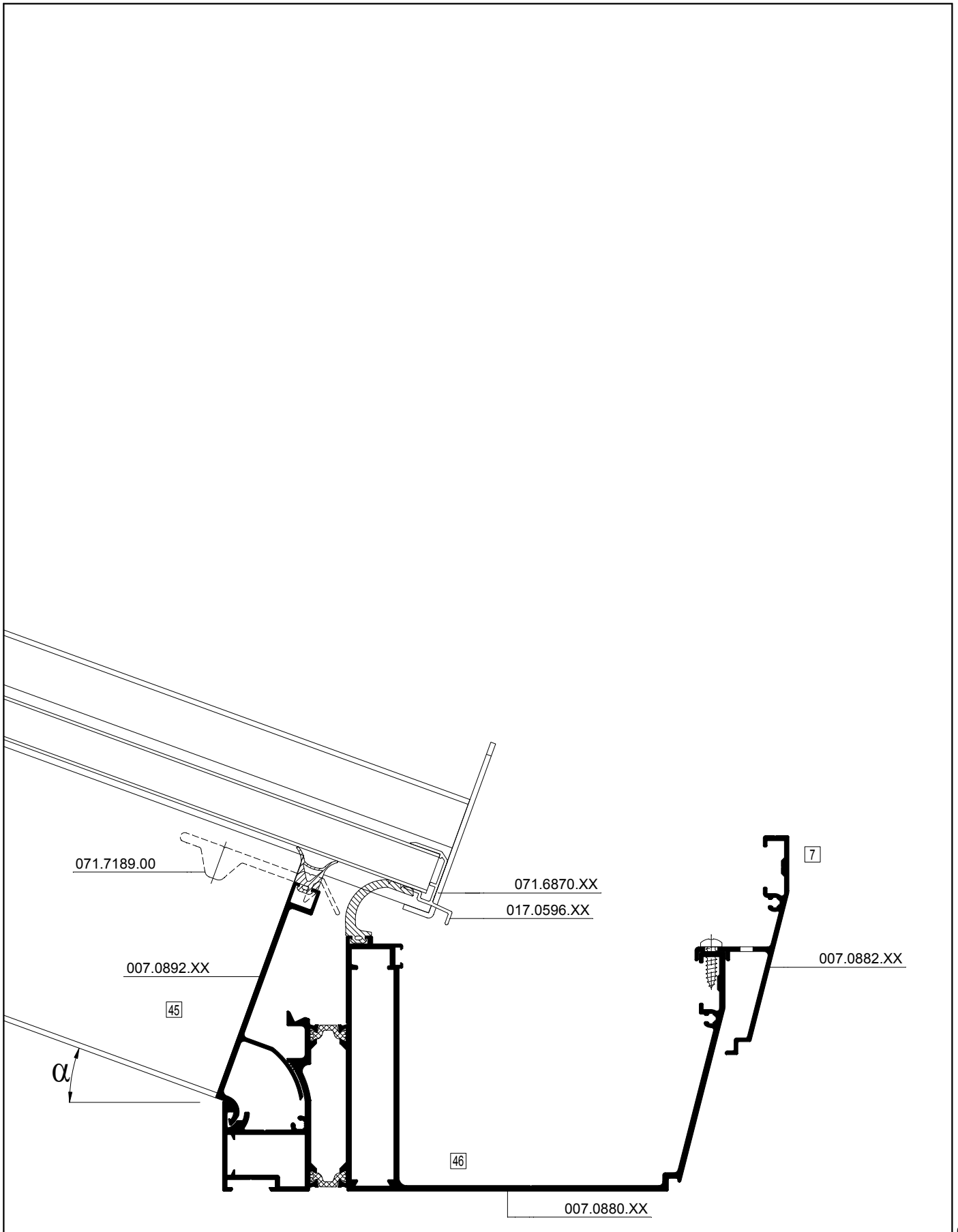



$5^\circ < \alpha < 25^\circ$  (007.0892.XX)

$25^\circ < \alpha < 45^\circ$  (007.0893.XX)

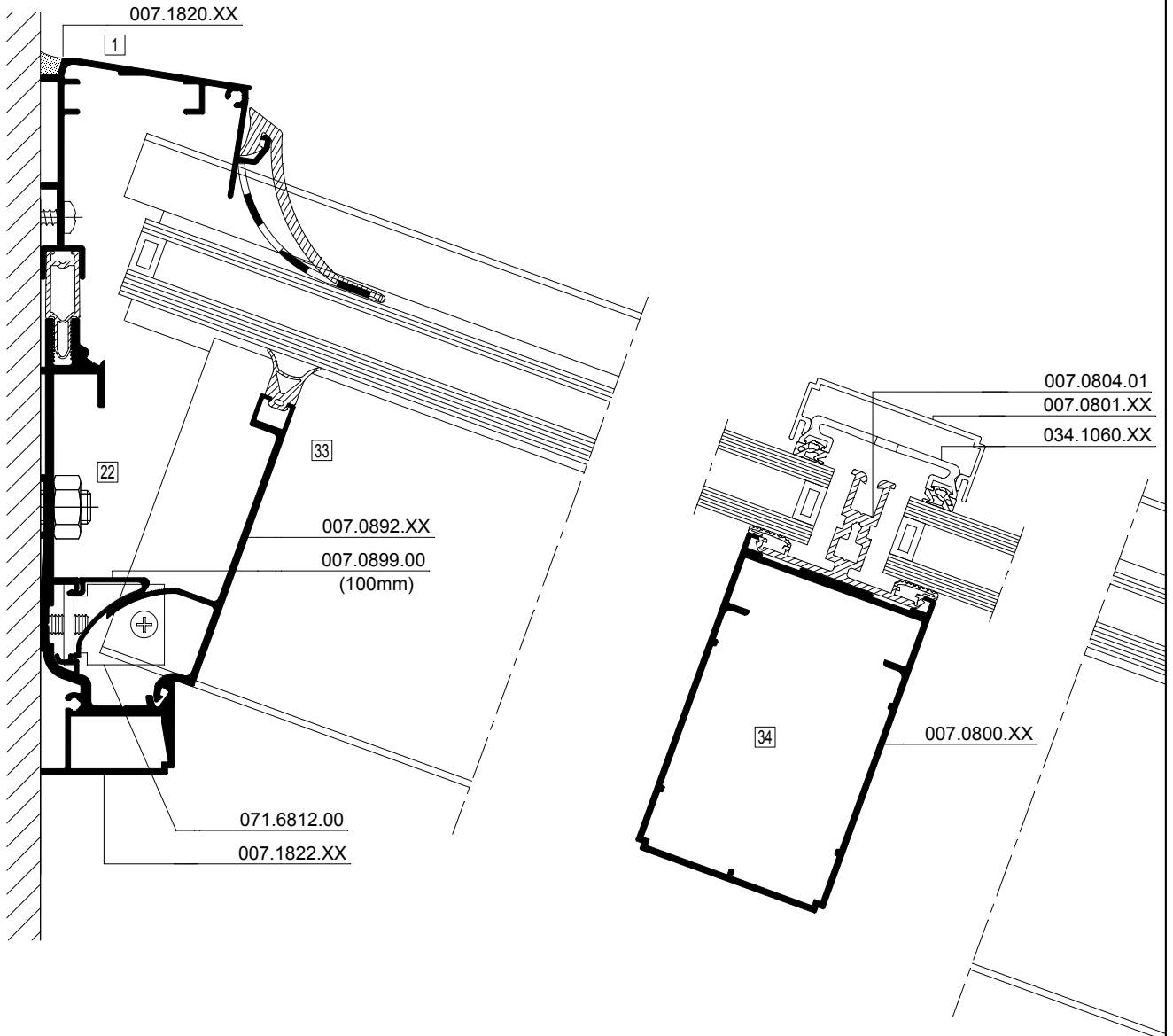

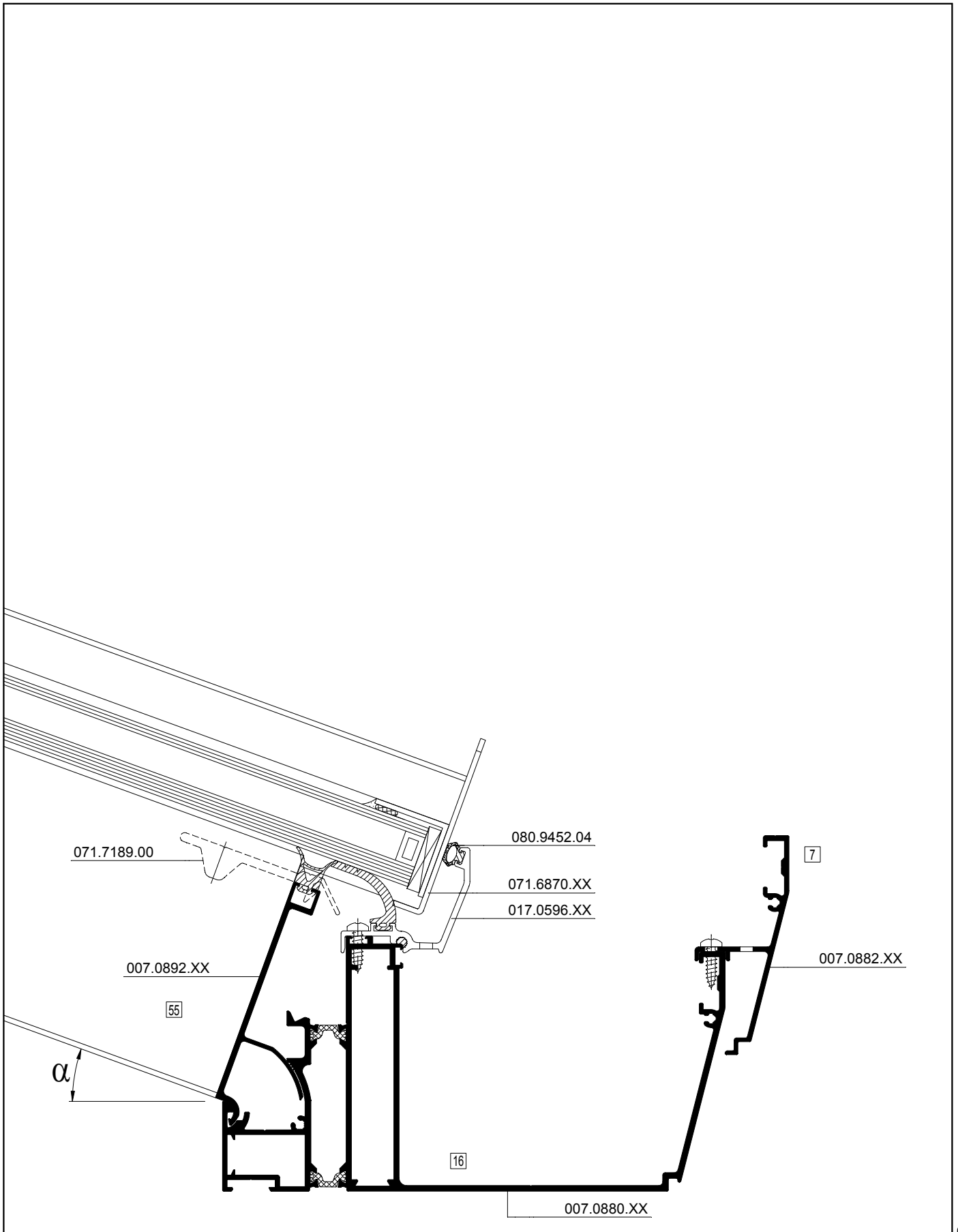
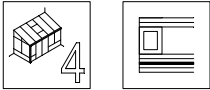



$5^\circ < \alpha < 30^\circ$

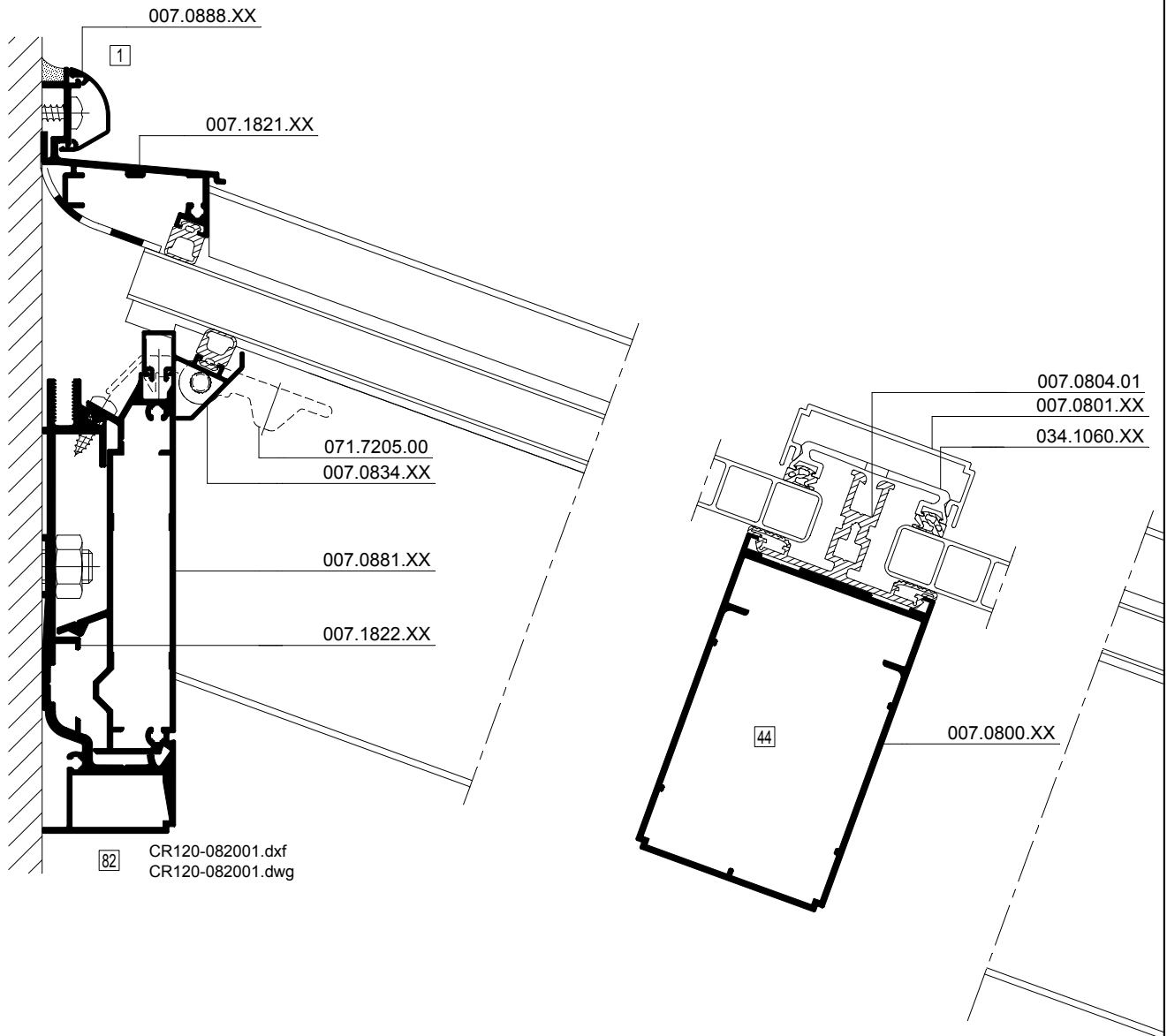

007.0880.XX

$I_x = 417.296 \text{ cm}^4$

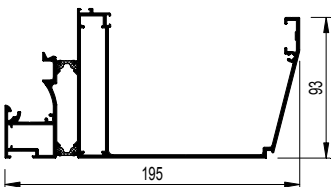

86 CR120-086001.dxf  
CR120-086001.dwg

007.0897.XX

$I_x = 622.134 \text{ cm}^4$

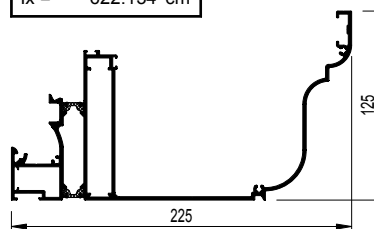

86 CR120-086002.dxf  
CR120-086002.dwg





### 007.0878.XX + 017.0880.XX

lx = 345.117 cm<sup>4</sup>

lx = 7.388 cm<sup>4</sup>

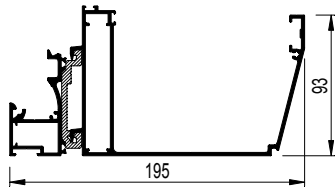

86 CR120-086003.dxf  
CR120-086003.dwg

### 007.0875.XX + 007.0872.XX

lx = 1610.268 cm<sup>4</sup>

lx = 987.897 cm<sup>4</sup>

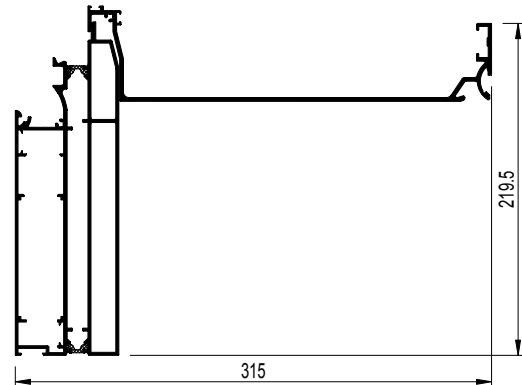

86 CR120-086005.dxf  
CR120-086005.dwg

### 007.0889.XX + 017.0880.XX

lx = 529.296 cm<sup>4</sup>

lx = 7.388 cm<sup>4</sup>

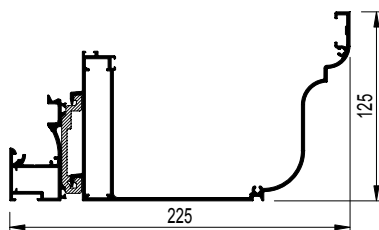

86 CR120-086004.dxf  
CR120-086004.dwg

### 007.0876.XX

lx = 456.212 cm<sup>4</sup>

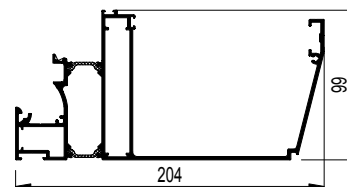

86 CR120-086006.dxf  
CR120-086006.dwg

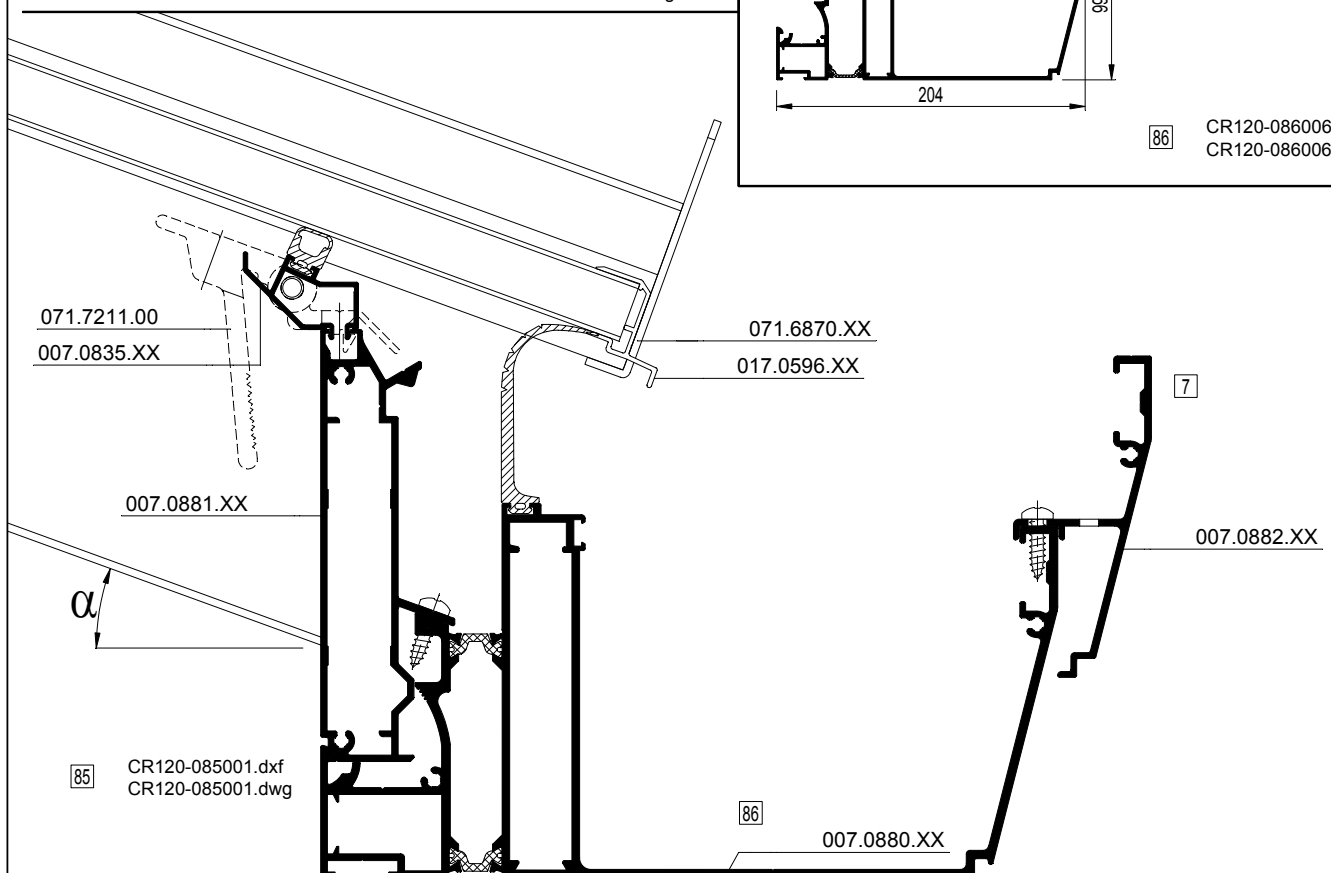

85 CR120-085001.dxf  
CR120-085001.dwg

86 007.0880.XX

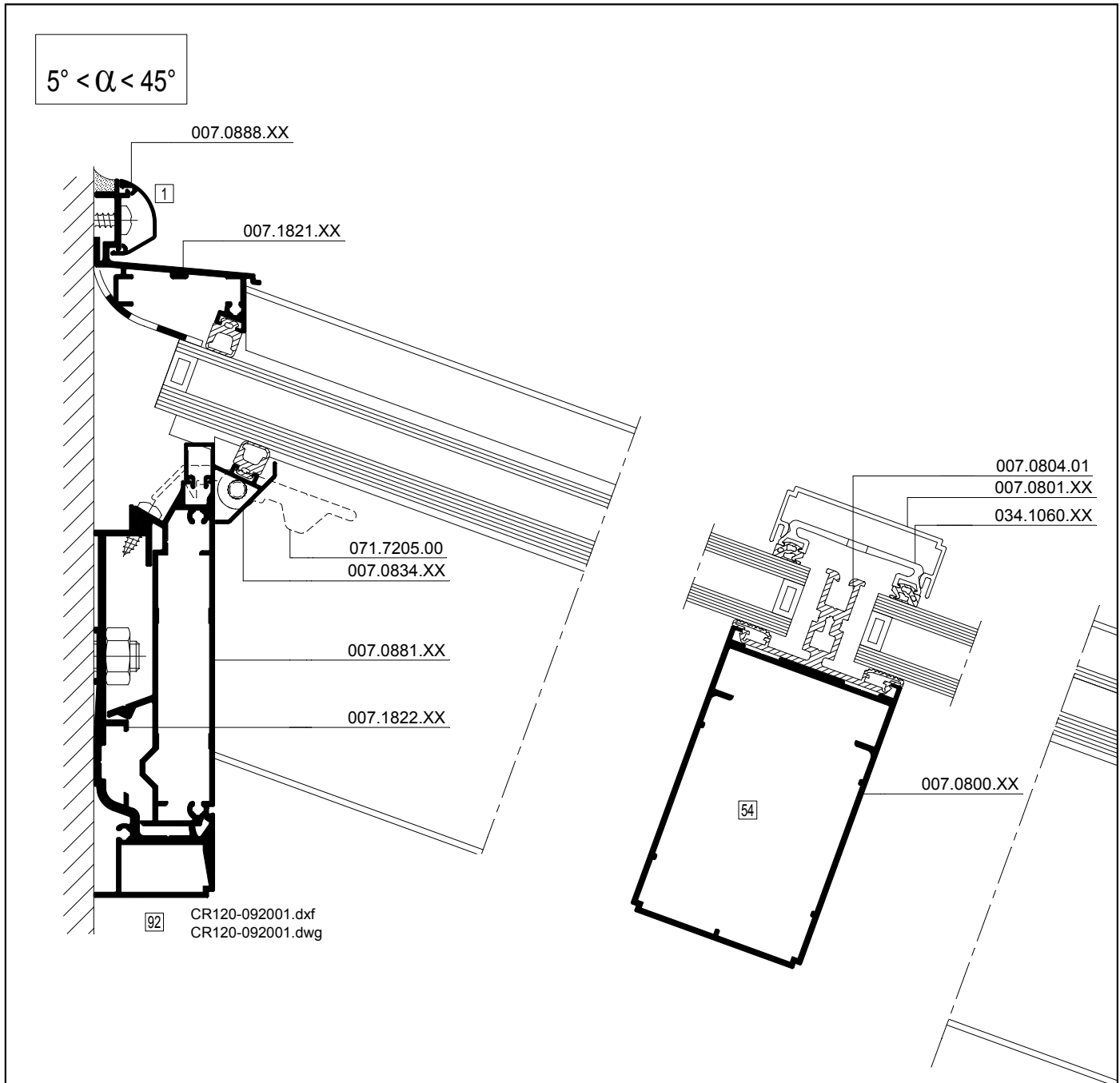

## 007.0880.XX

$I_x = 417.296 \text{ cm}^4$

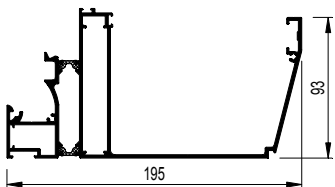

96 CR120-096001.dxf  
CR120-096001.dwg

## 007.0897.XX

$I_x = 622.134 \text{ cm}^4$

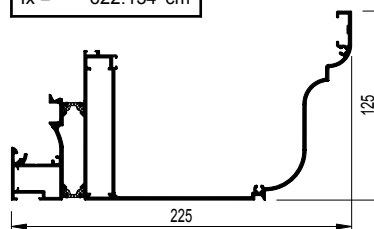

96 CR120-096002.dxf  
CR120-096002.dwg



## 007.0878.XX + 017.0880.XX

lx = 345.117 cm<sup>2</sup>

lx = 7.388 cm<sup>2</sup>

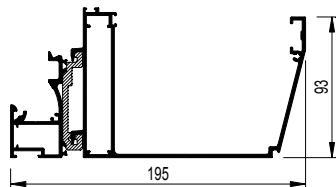

96 CR120-096003.dxf  
CR120-096003.dwg

## 007.0875.XX + 007.0872.XX

lx = 1610.268 cm<sup>2</sup>

lx = 987.897 cm<sup>2</sup>

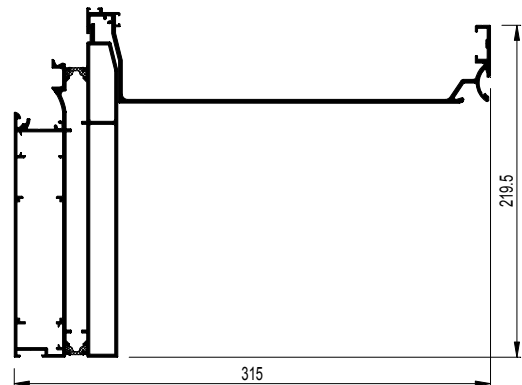

96 CR120-096005.dxf  
CR120-096005.dwg

## 007.0889.XX + 017.0880.XX

lx = 529.296 cm<sup>2</sup>

lx = 7.388 cm<sup>2</sup>

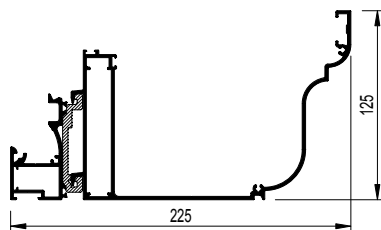

96 CR120-096004.dxf  
CR120-096004.dwg

## 007.0876.XX

lx = 456.212 cm<sup>2</sup>

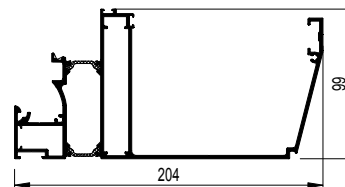

96 CR120-096006.dxf  
CR120-096006.dwg

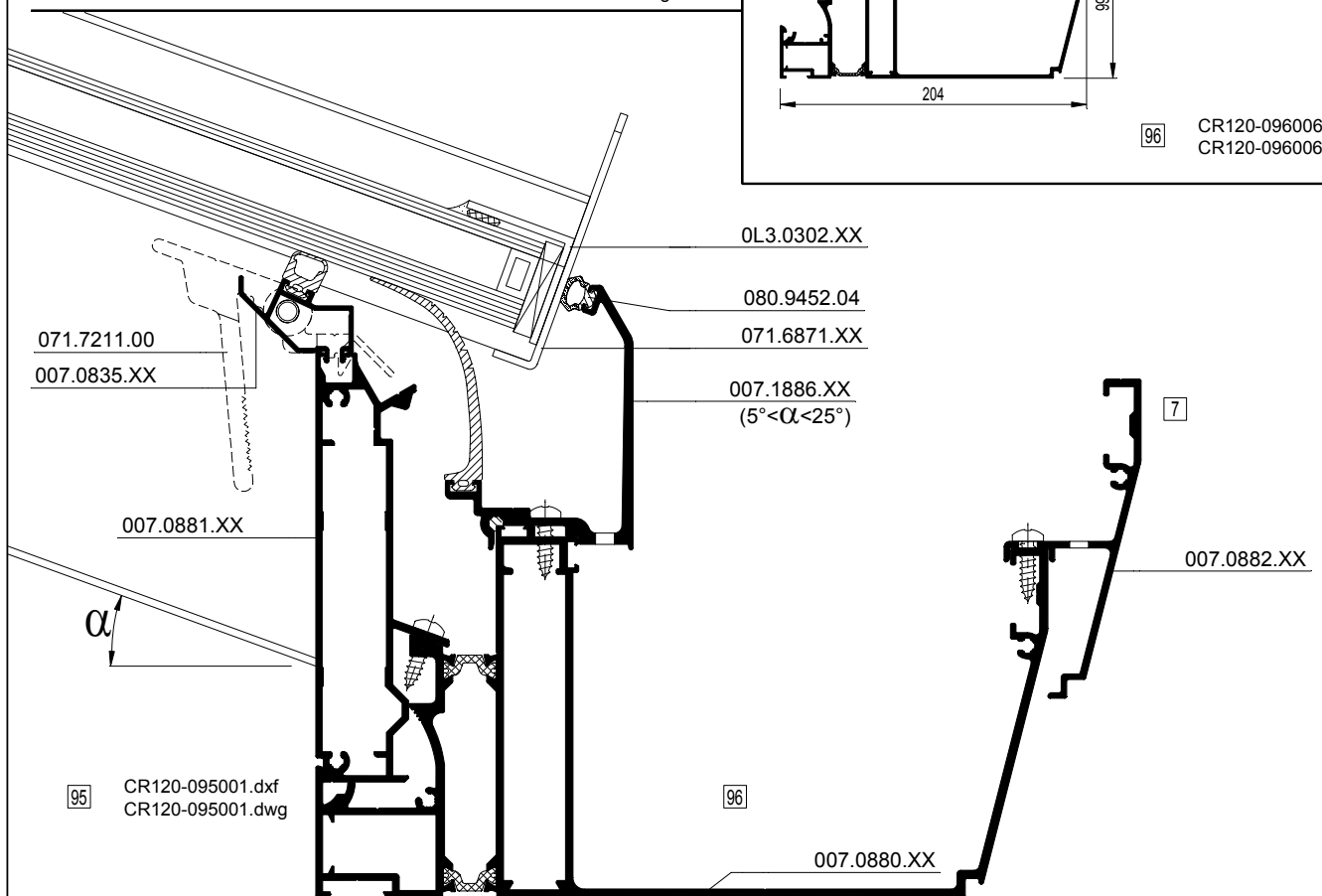

95 CR120-095001.dxf  
CR120-095001.dwg

96



$5^\circ < \alpha < 25^\circ$

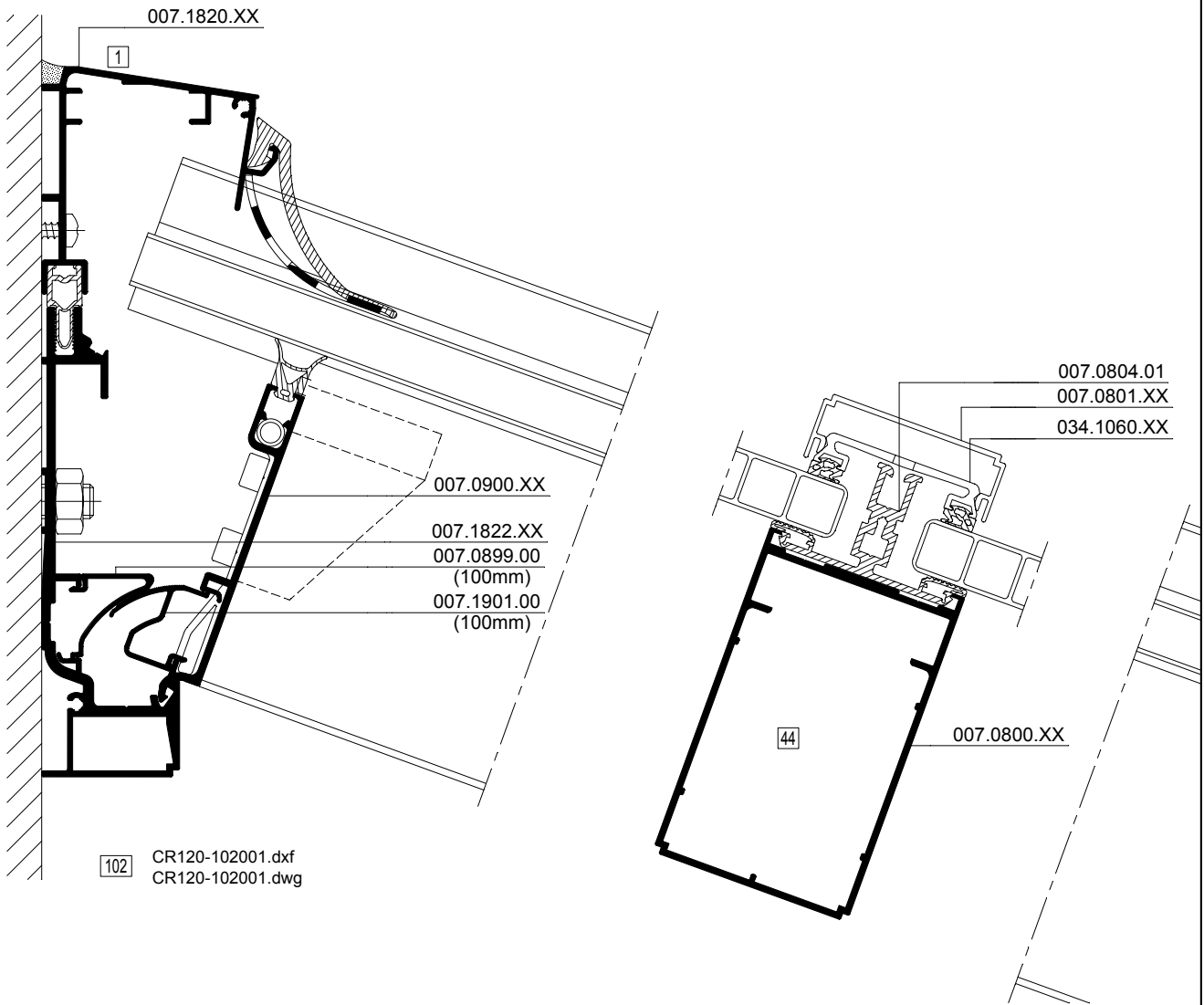

007.0880.XX

$I_x = 417.296 \text{ cm}^4$

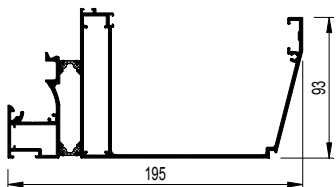

106 CR120-106001.dxf  
CR120-106001.dwg

007.0897.XX

$I_x = 622.134 \text{ cm}^4$

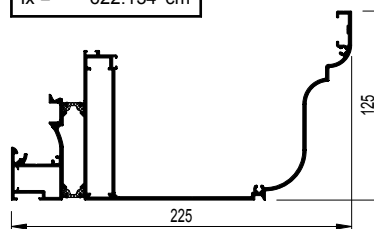

106 CR120-106002.dxf  
CR120-106002.dwg



## 007.0878.XX + 017.0880.XX

lx = 345.117 cm<sup>2</sup>

lx = 7.388 cm<sup>4</sup>

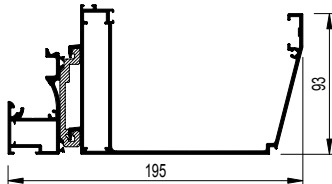

106 CR120-106003.dxf  
CR120-106003.dwg

## 007.0875.XX + 007.0872.XX

lx = 1610.268 cm<sup>2</sup>

lx = 987.897 cm<sup>4</sup>

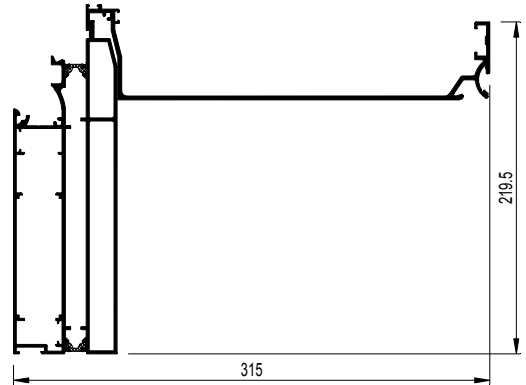

106 CR120-106005.dxf  
CR120-106005.dwg

## 007.0889.XX + 017.0880.XX

lx = 529.296 cm<sup>2</sup>

lx = 7.388 cm<sup>4</sup>

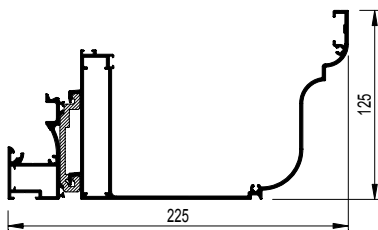

106 CR120-106004.dxf  
CR120-106004.dwg

## 007.0876.XX

lx = 456.212 cm<sup>2</sup>

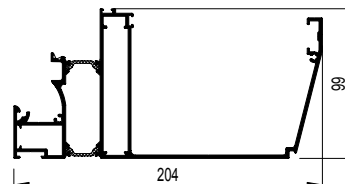

106 CR120-106006.dxf  
CR120-106006.dwg

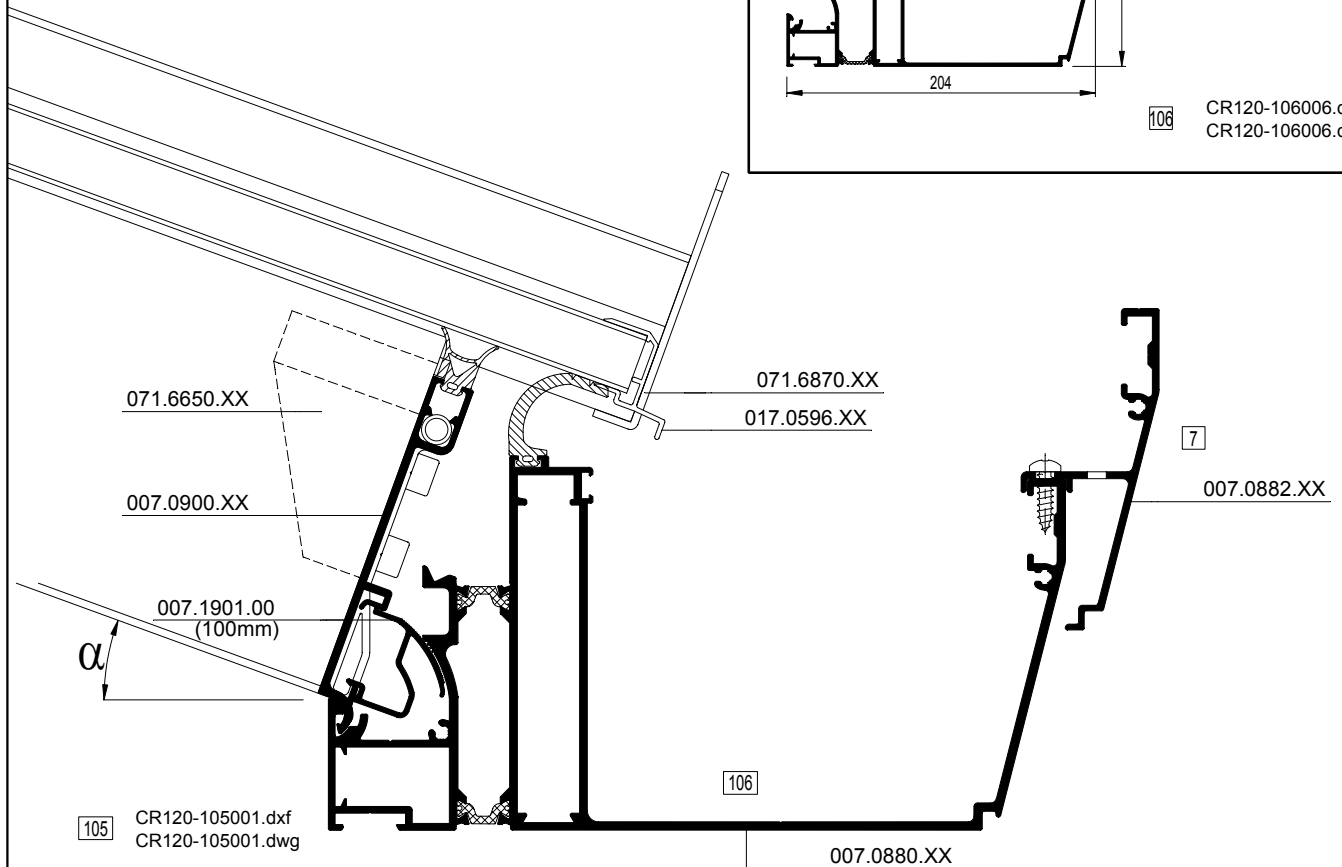

105 CR120-105001.dxf  
CR120-105001.dwg

106

7

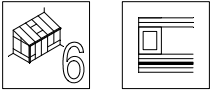

$5^\circ < \alpha < 25^\circ$

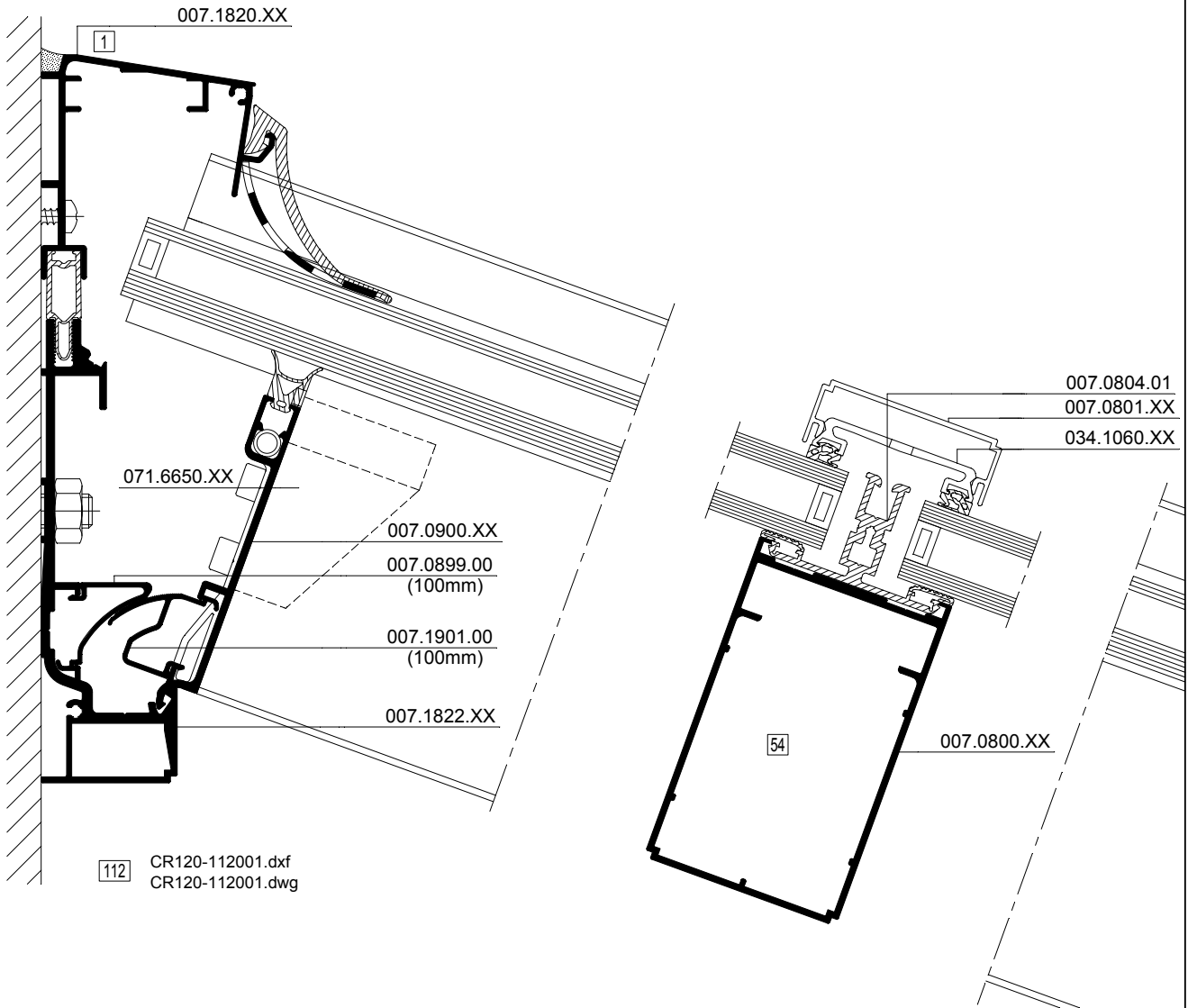

007.0880.XX

$I_x = 417.296 \text{ cm}^4$

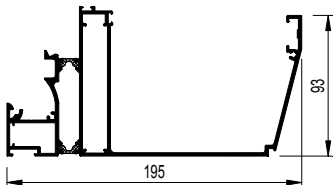

116 CR120-116001.dxf  
CR120-116001.dwg

007.0897.XX

$I_x = 622.134 \text{ cm}^4$

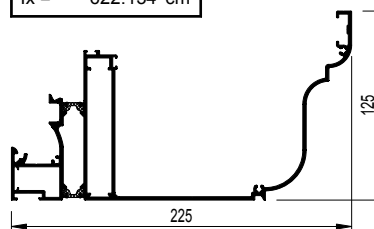

116 CR120-116002.dxf  
CR120-116002.dwg



## 007.0878.XX + 017.0880.XX

lx = 345.117 cm<sup>4</sup>    lx = 7.388 cm<sup>4</sup>

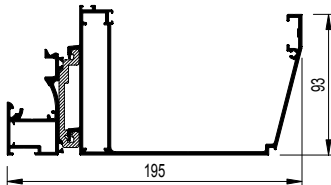

116 CR120-116003.dxf  
CR120-116003.dwg

## 007.0875.XX + 007.0872.XX

lx = 1610.268 cm<sup>4</sup>    lx = 987.897 cm<sup>4</sup>

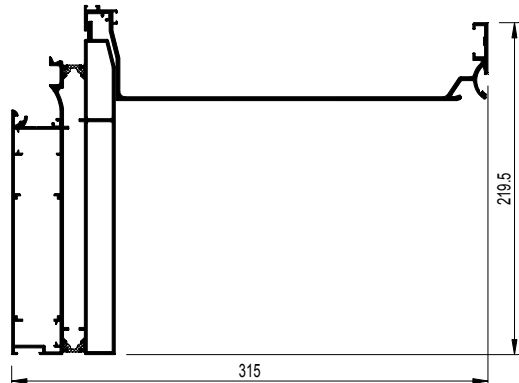

116 CR120-116005.dxf  
CR120-116005.dwg

## 007.0889.XX + 017.0880.XX

lx = 529.296 cm<sup>4</sup>    lx = 7.388 cm<sup>4</sup>

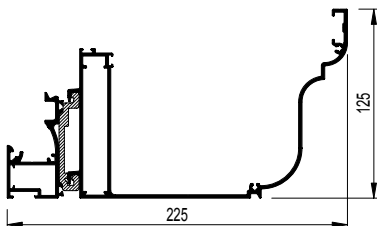

116 CR120-116004.dxf  
CR120-116004.dwg

## 007.0876.XX

lx = 456.212 cm<sup>4</sup>

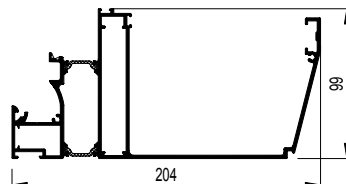

116 CR120-116006.dxf  
CR120-116006.dwg

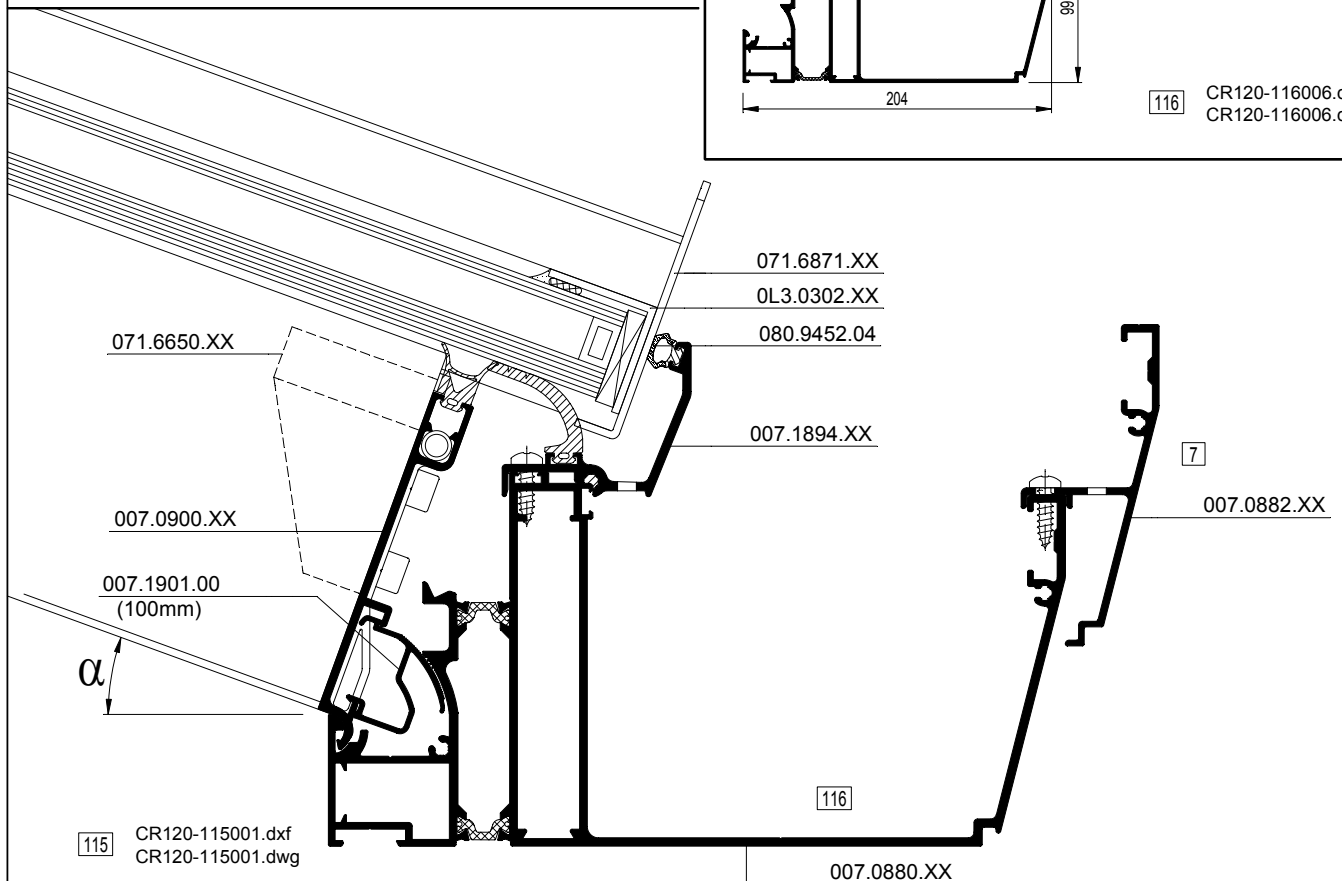

115 CR120-115001.dxf  
CR120-115001.dwg

116

007.0880.XX

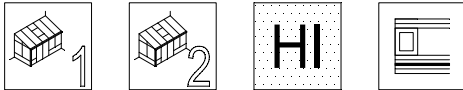

$5^\circ < \alpha < 28^\circ$  (007.0890.XX)

$28^\circ < \alpha < 45^\circ$  (007.0891.XX)

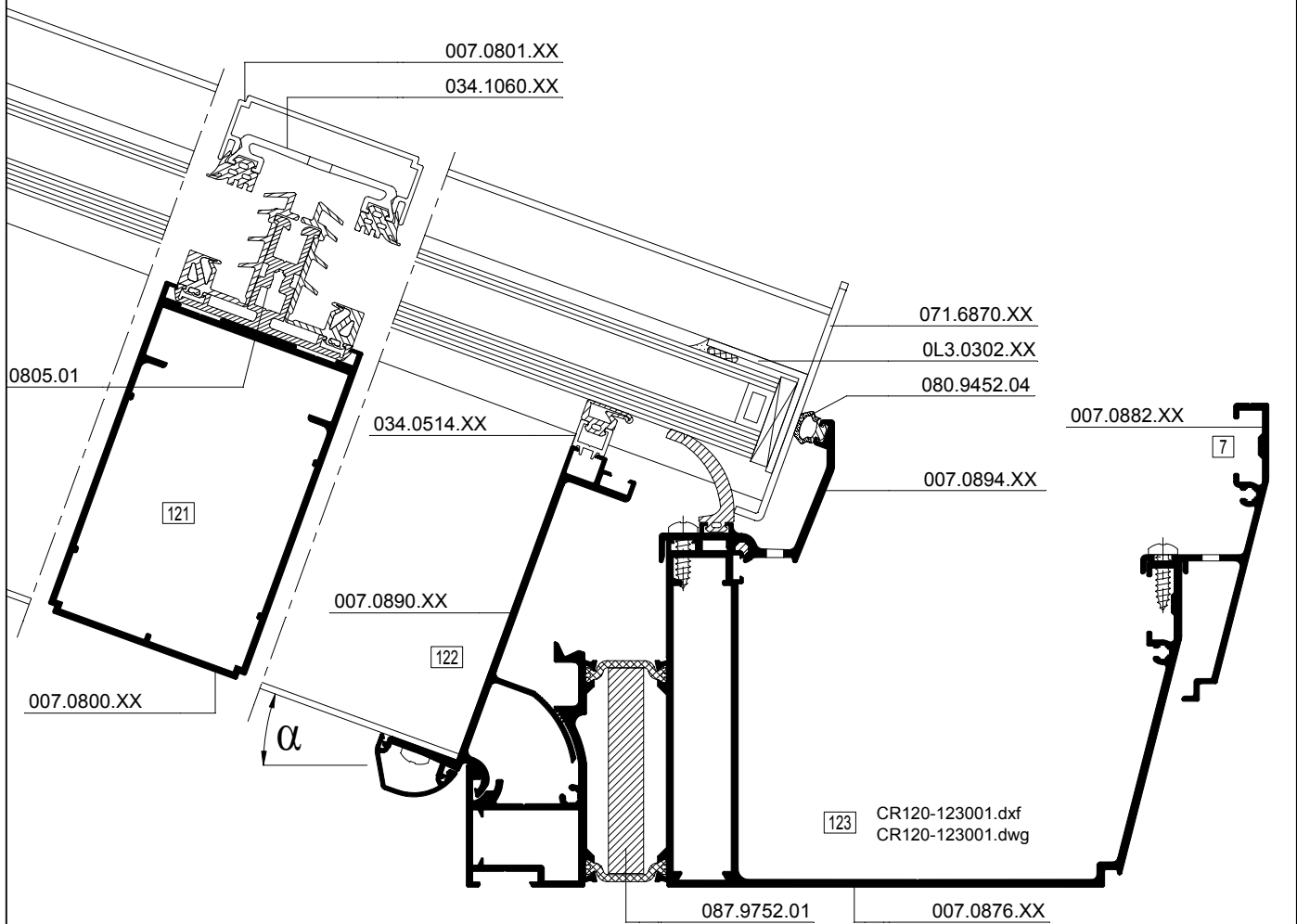

007.0890.XX

$I_x = 46.235 \text{ cm}^4$

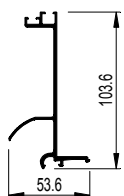

122 CR120-122001.dxf  
CR120-122001.dwg

007.0891.XX

$I_x = 60.945 \text{ cm}^4$

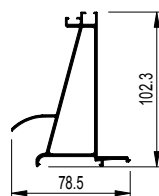

122 CR120-122002.dxf  
CR120-122002.dwg

007.0859.XX



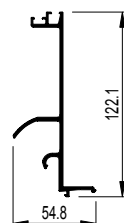







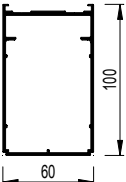

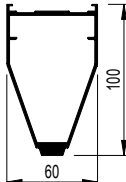

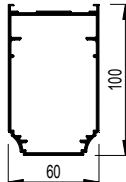

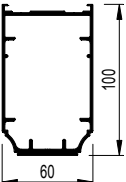

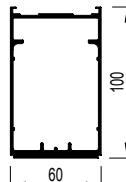

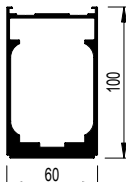

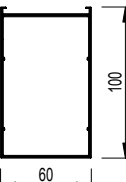

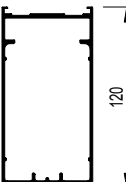
$I_x = 71.409 \text{ cm}^4$

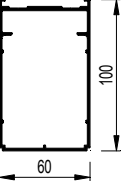

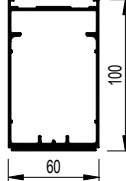
122 CR120-122003.dxf  
CR120-122003.dwg

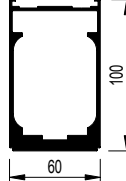

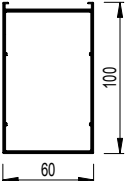

 <p><b>007.0800.XX</b></p> <p>lx = 83.126 cm<sup>4</sup></p>  <p> CR120-121001.dxf CR120-121001.dwg</p>	<p><b>007.0810.XX</b></p> <p>lx = 83.820 cm<sup>4</sup></p>  <p> CR120-121002.dxf CR120-121002.dwg</p>	<p><b>007.0815.XX</b></p> <p>lx = 81.450 cm<sup>4</sup></p>  <p> CR120-121003.dxf CR120-121003.dwg</p>	<p><b>007.0814.XX</b></p> <p>lx = 102.598 cm<sup>4</sup></p>  <p> CR120-121004.dxf CR120-121004.dwg</p>
<p><b>007.0803.XX</b></p> <p>lx = 119.471 cm<sup>4</sup></p>  <p> CR120-121005.dxf CR120-121005.dwg</p>	<p><b>007.0813.XX</b></p> <p>lx = 151.075 cm<sup>4</sup></p>  <p> CR120-121006.dxf CR120-121006.dwg</p>	<p><b>007.0797.XX</b></p> <p>lx = 77.689 cm<sup>4</sup></p>  <p> CR120-121007.dxf CR120-121007.dwg</p>	<p><b>007.0798.XX</b></p> <p>lx = 186.767 cm<sup>4</sup></p>  <p> CR120-121008.dxf CR120-121008.dwg</p>
 <p><b>007.0800.XX</b></p> <p>lx = 83.126 cm<sup>4</sup></p>  <p> CR120-121009.dxf CR120-121009.dwg</p>	<p><b>007.0803.XX</b></p> <p>lx = 119.471 cm<sup>4</sup></p>  <p> CR120-121010.dxf CR120-121010.dwg</p>	<p><b>007.0813.XX</b></p> <p>lx = 151.075 cm<sup>4</sup></p>  <p> CR120-121011.dxf CR120-121011.dwg</p>	
<p><b>007.0797.XX</b></p> <p>lx = 77.689 cm<sup>4</sup></p>  <p> CR120-121012.dxf CR120-121012.dwg</p>			

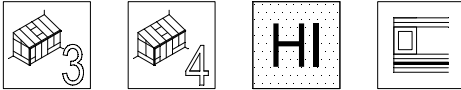

$5^\circ < \alpha < 25^\circ$  (007.0892.XX)

$25^\circ < \alpha < 45^\circ$  (007.0893.XX)

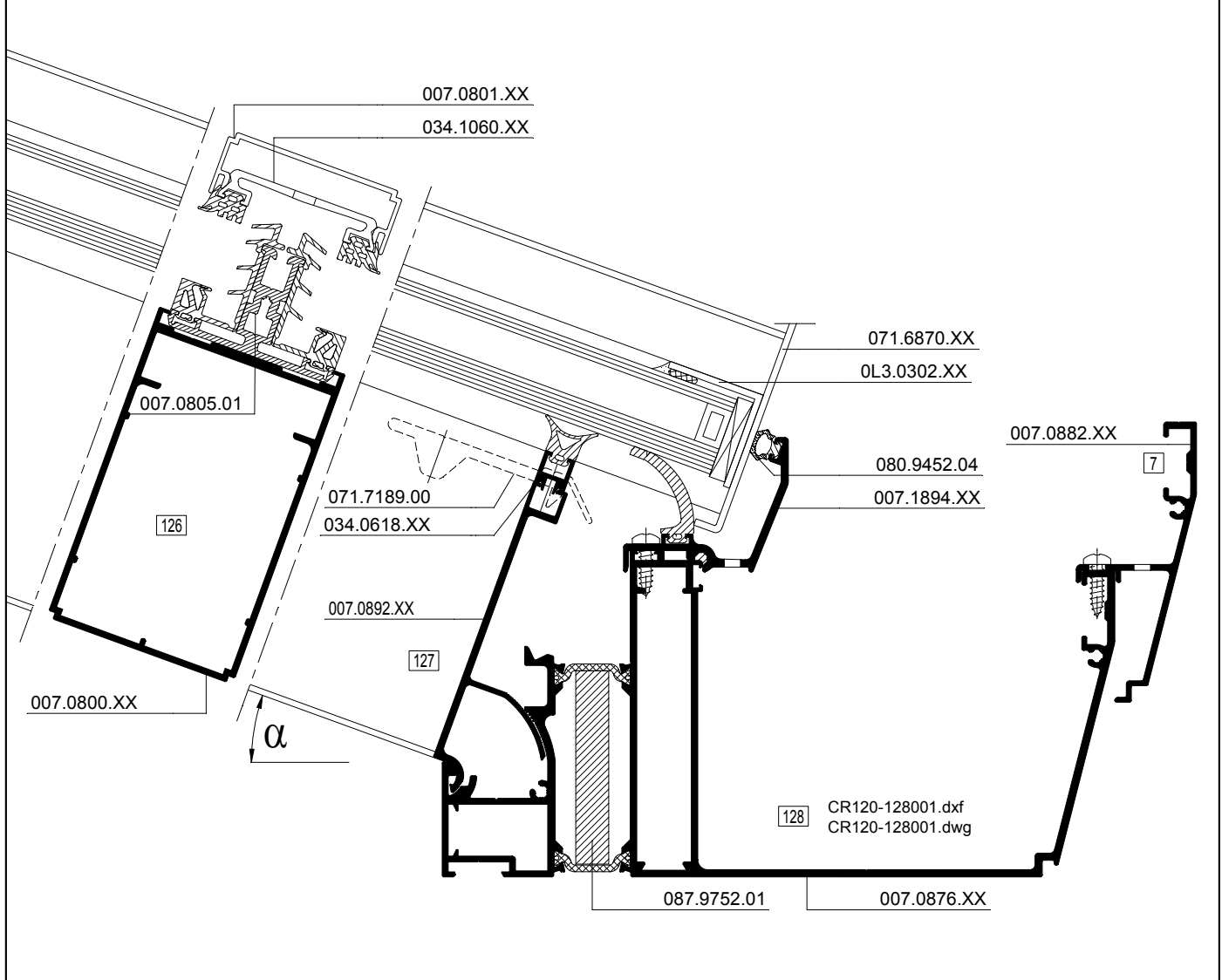

007.0892.XX

$I_x = 23.863 \text{ cm}^4$

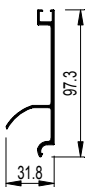

127 CR120-127001.dxf  
CR120-127001.dwg

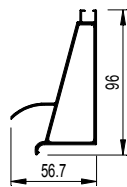

007.0893.XX

$I_x = 37.272 \text{ cm}^4$



127 CR120-127002.dxf  
CR120-127002.dwg

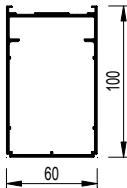
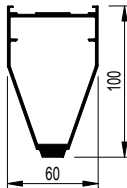
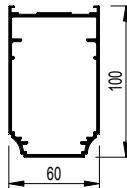
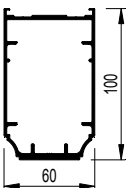
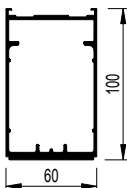
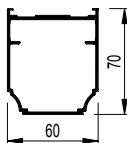
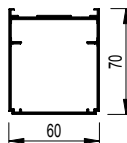
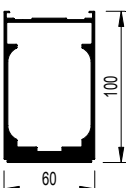

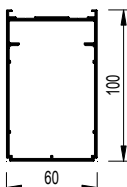
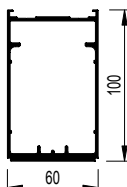
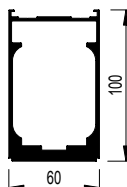
 <p>007.0800.XX</p> <p>lx = 83.126 cm<sup>2</sup></p>  <p>126 CR120-126001.dxf CR120-126001.dwg</p>	<p>007.0810.XX</p> <p>lx = 83.820 cm<sup>2</sup></p>  <p>126 CR120-126002.dxf CR120-126002.dwg</p>	<p>007.0815.XX</p> <p>lx = 81.450 cm<sup>2</sup></p>  <p>126 CR120-126003.dxf CR120-126003.dwg</p>	<p>007.0814.XX</p> <p>lx = 102.598 cm<sup>2</sup></p>  <p>126 CR120-126004.dxf CR120-126004.dwg</p>	<p>007.0803.XX</p> <p>lx = 119.471 cm<sup>2</sup></p>  <p>126 CR120-126005.dxf CR120-126005.dwg</p>	<p>007.0817.XX</p> <p>lx = 29.659 cm<sup>2</sup></p>  <p>126 CR120-126006.dxf CR120-126006.dwg</p>	<p>007.0802.XX</p> <p>lx = 32.169 cm<sup>2</sup></p>  <p>126 CR120-126007.dxf CR120-126007.dwg</p>
<p>007.0813.XX</p> <p>lx = 151.075 cm<sup>2</sup></p>  <p>126 CR120-126008.dxf CR120-126008.dwg</p>						
 <p>007.0800.XX</p> <p>lx = 83.126 cm<sup>2</sup></p>  <p>126 CR120-126009.dxf CR120-126009.dwg</p>	<p>007.0803.XX</p> <p>lx = 119.471 cm<sup>2</sup></p>  <p>126 CR120-126010.dxf CR120-126010.dwg</p>	<p>007.0813.XX</p> <p>lx = 151.075 cm<sup>2</sup></p>  <p>126 CR120-126011.dxf CR120-126011.dwg</p>				

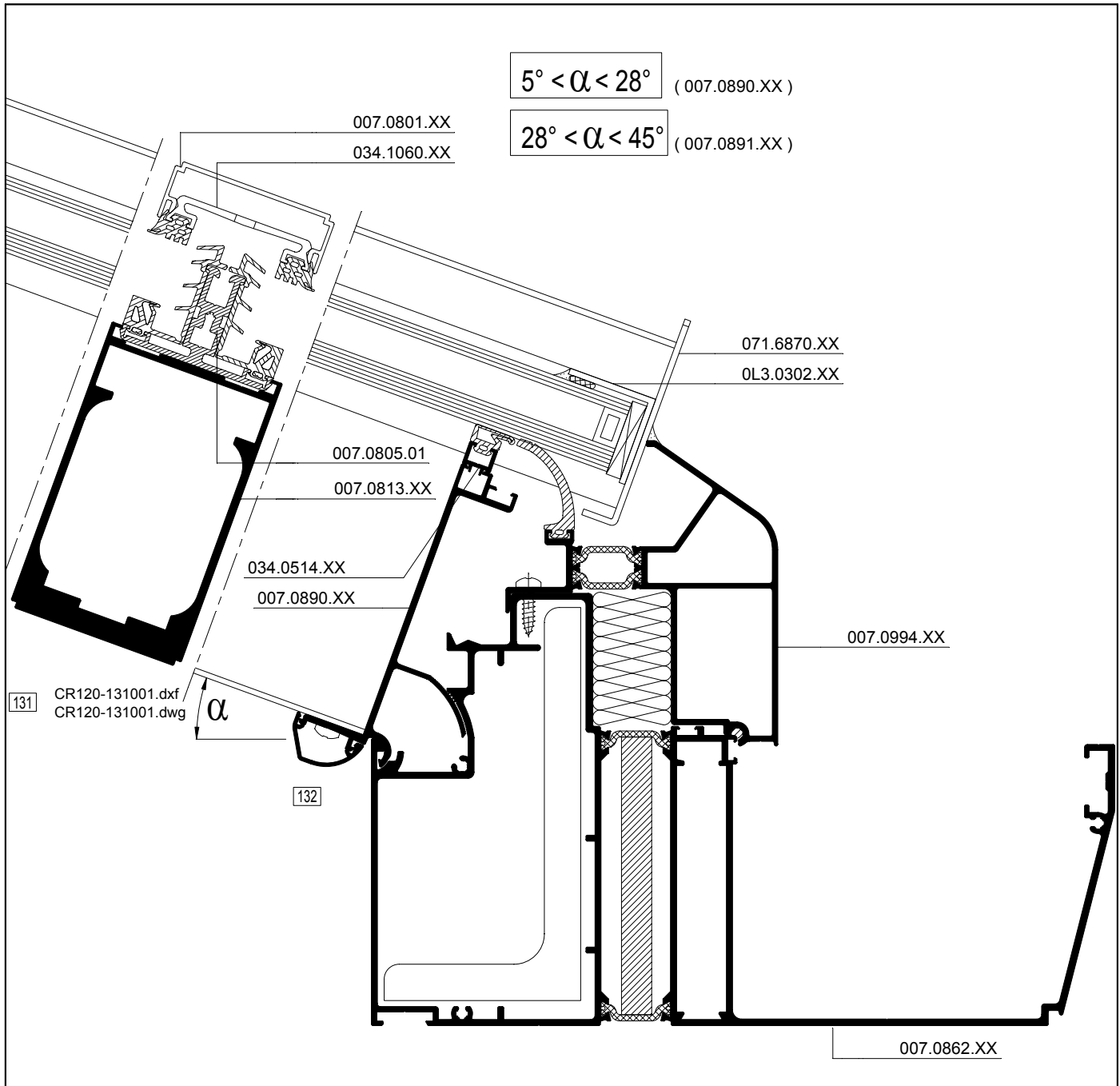

## 007.0890.XX

$I_x = 46.235 \text{ cm}^4$

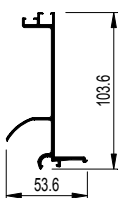

132 CR120-132001.dxf  
CR120-132001.dwg

## 007.0891.XX

$I_x = 60.945 \text{ cm}^4$

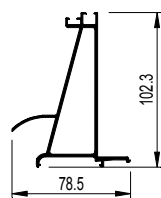

132 CR120-132002.dxf  
CR120-132002.dwg

## 007.0859.XX

$I_x = 71.409 \text{ cm}^4$

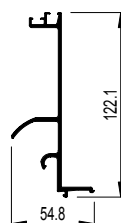

132 CR120-132003.dxf  
CR120-132003.dwg

## 007.0798.XX

$I_x = 186.767 \text{ cm}^4$

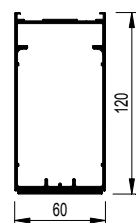

131 CR120-131002.dxf  
CR120-131002.dwg

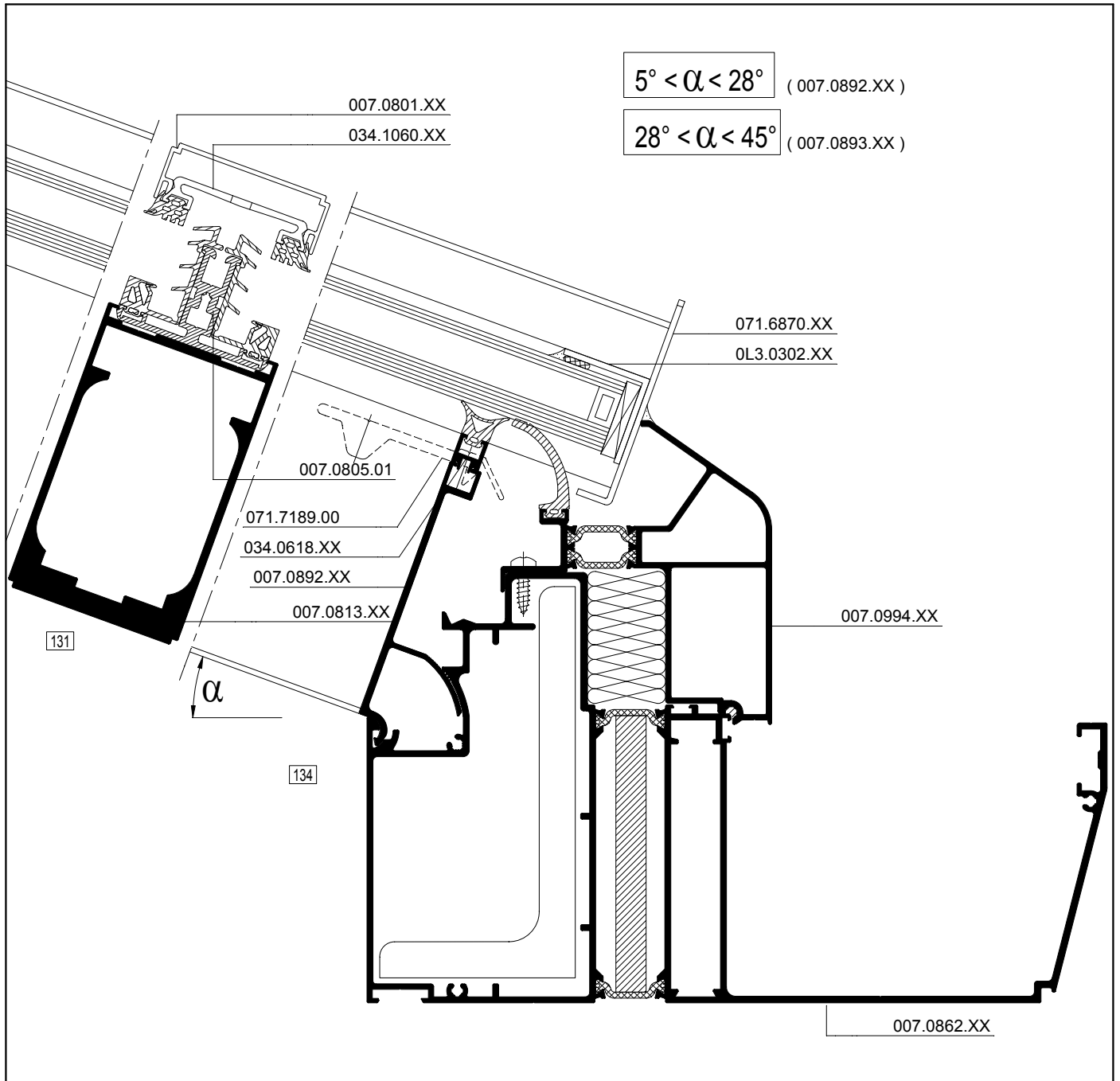
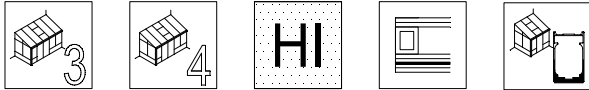

007.0892.XX

$I_x = 23.863 \text{ cm}^4$

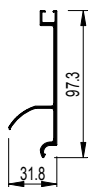

CR120-134001.dxf  
CR120-134001.dwg

007.0893.XX

$I_x = 37.272 \text{ cm}^4$

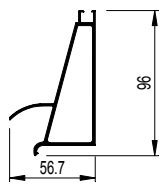

134 CR120-134002.dxf  
CR120-134002.dwg



$5^\circ < \alpha < 25^\circ$  (007.1886.XX)

$25^\circ < \alpha < 45^\circ$  (007.1885.XX)

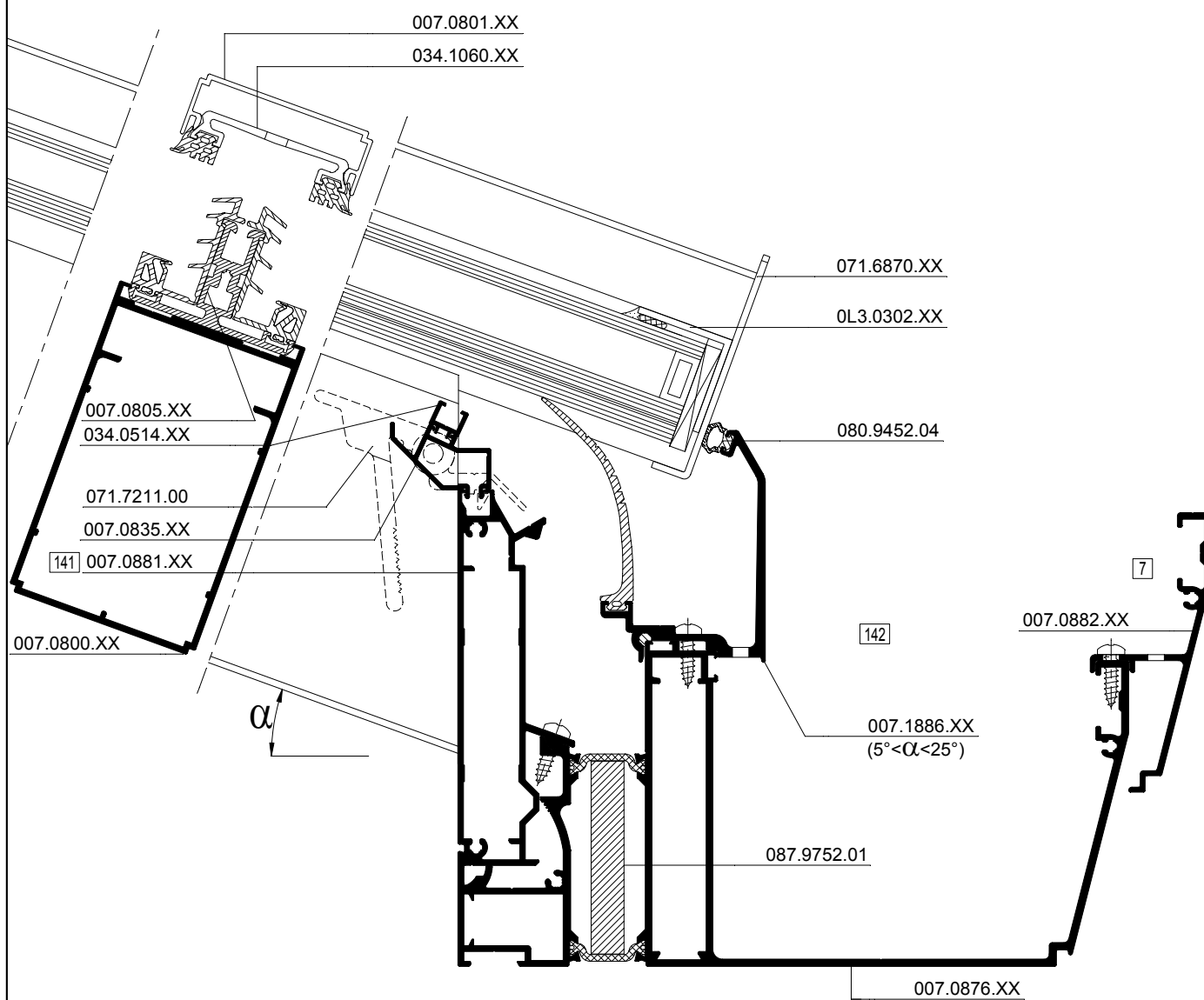



<p><b>007.0800.XX</b></p> <p><math>I_x = 83.126 \text{ cm}^4</math></p> <p><b>141</b> CR120-141001.dxf CR120-141001.dwg</p>	<p><b>007.0810.XX</b></p> <p><math>I_x = 83.820 \text{ cm}^4</math></p> <p><b>141</b> CR120-141002.dxf CR120-141002.dwg</p>	<p><b>007.0815.XX</b></p> <p><math>I_x = 81.450 \text{ cm}^4</math></p> <p><b>141</b> CR120-141003.dxf CR120-141003.dwg</p>	<p><b>007.0814.XX</b></p> <p><math>I_x = 102.598 \text{ cm}^4</math></p> <p><b>141</b> CR120-141004.dxf CR120-141004.dwg</p>
<p><b>007.0803.XX</b></p> <p><math>I_x = 119.471 \text{ cm}^4</math></p> <p><b>141</b> CR120-141005.dxf CR120-141005.dwg</p>	<p><b>007.0813.XX</b></p> <p><math>I_x = 151.075 \text{ cm}^4</math></p> <p><b>141</b> CR120-141006.dxf CR120-141006.dwg</p>	<p><b>007.0817.XX</b></p> <p><math>I_x = 29.659 \text{ cm}^4</math></p> <p><b>141</b> CR120-141007.dxf CR120-141007.dwg</p>	<p><b>007.0802.XX</b></p> <p><math>I_x = 32.169 \text{ cm}^4</math></p> <p><b>141</b> CR120-141008.dxf CR120-141008.dwg</p>
<p><b>007.0798.XX</b></p> <p><math>I_x = 186.767 \text{ cm}^4</math></p> <p><b>141</b> CR120-141009.dxf CR120-141009.dwg</p>	<p><b>007.0799.XX</b></p> <p><math>I_x = 499.551 \text{ cm}^4</math></p> <p><b>141</b> CR120-141010.dxf CR120-141010.dwg</p>		
<p><b>007.1886.XX</b></p> <p><math>I_x = 9.079 \text{ cm}^4</math></p> <p><b>142</b> CR120-142001.dxf CR120-142001.dwg</p>	<p><b>007.1885.XX</b></p> <p><math>I_x = 7.307 \text{ cm}^4</math></p> <p><b>142</b> CR120-142002.dxf CR120-142002.dwg</p>		

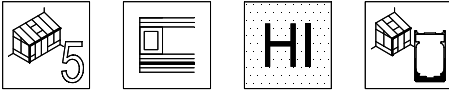

$5^\circ < \alpha < 25^\circ$  (007.0986.XX)

$25^\circ < \alpha < 45^\circ$  (007.0985.XX)

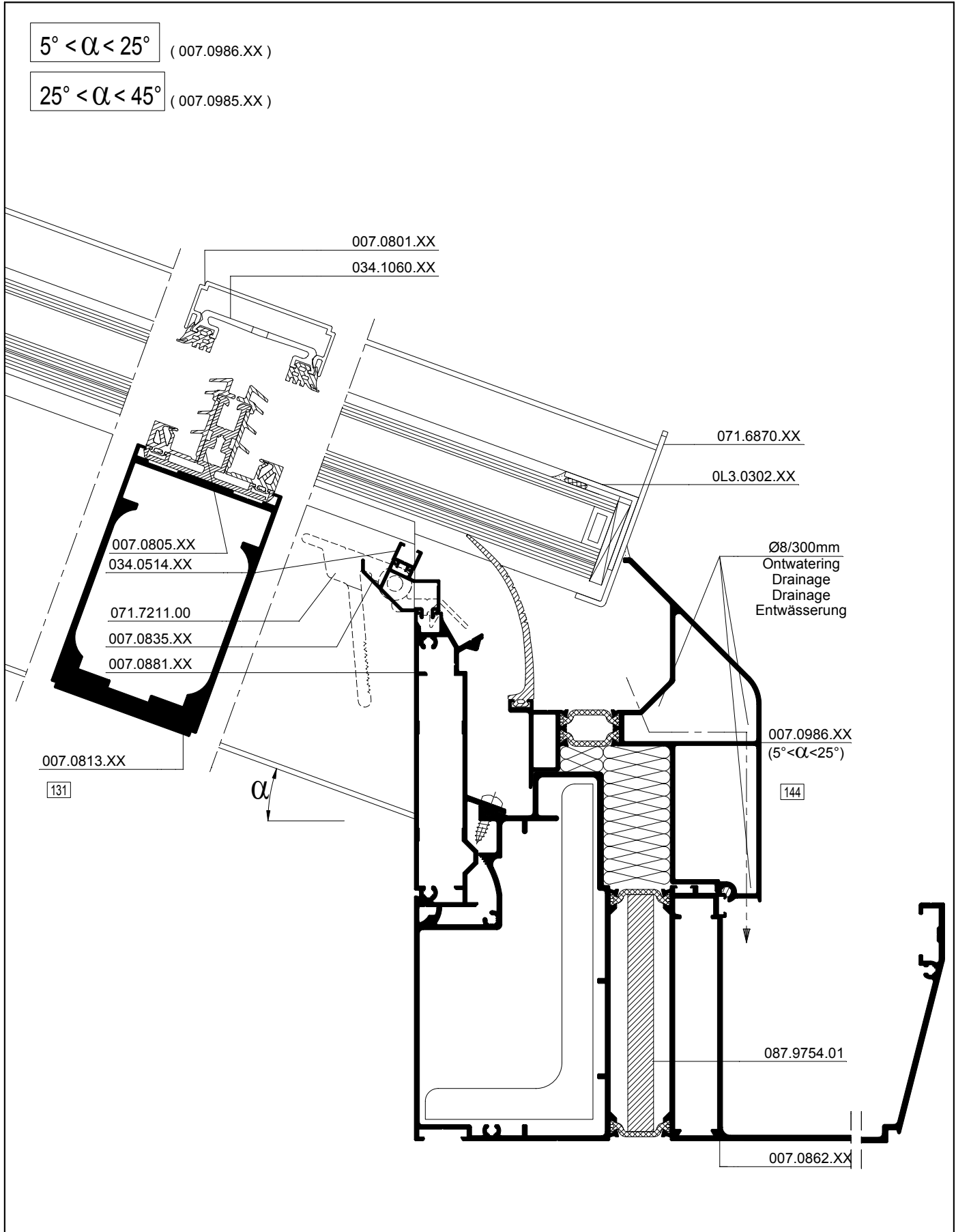





007.0986.XX

$I_x = 51.396 \text{ cm}^4$

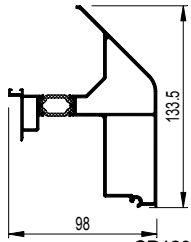

144

CR120-144001.dxf  
CR120-144001.dwg

007.0985.XX

$I_x = 49.564 \text{ cm}^4$

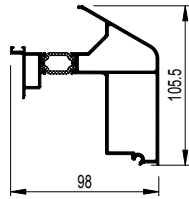

144

CR120-144002.dxf  
CR120-144002.dwg

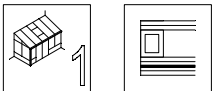

<p><b>007.0800.XX</b></p> <p>lx = 83.126 cm<sup>2</sup></p> <p>152 CR120-152001.dxf CR120-152001.dwg</p>	<p><b>007.0810.XX</b></p> <p>lx = 83.820 cm<sup>2</sup></p> <p>152 CR120-152002.dxf CR120-152002.dwg</p>	<p><b>007.0815.XX</b></p> <p>lx = 81.450 cm<sup>2</sup></p> <p>152 CR120-152003.dxf CR120-152003.dwg</p>	<p><b>007.0814.XX</b></p> <p>lx = 102.598 cm<sup>2</sup></p> <p>152 CR120-152004.dxf CR120-152004.dwg</p>	
<p><b>007.0803.XX</b></p> <p>lx = 119.471 cm<sup>2</sup></p> <p>152 CR120-152005.dxf CR120-152005.dwg</p>	<p><b>007.0813.XX</b></p> <p>lx = 151.075 cm<sup>2</sup></p> <p>152 CR120-152006.dxf CR120-152006.dwg</p>	<p>071.6870.XX 0L3.0302.XX 080.9452.04 007.1894.XX 021.5146.07 022.3036.04 007.0853.XX 034.0514.XX 151 007.0888.XX 007.0891.XX 007.0852.XX</p>		
<p><b>007.0797.XX</b></p> <p>lx = 77.689 cm<sup>2</sup></p> <p>152 CR120-152007.dxf CR120-152007.dwg</p>	<p>5° &lt; α &lt; 28° (007.0890.XX)</p> <p>28° &lt; α &lt; 45° (007.0891.XX)</p>			

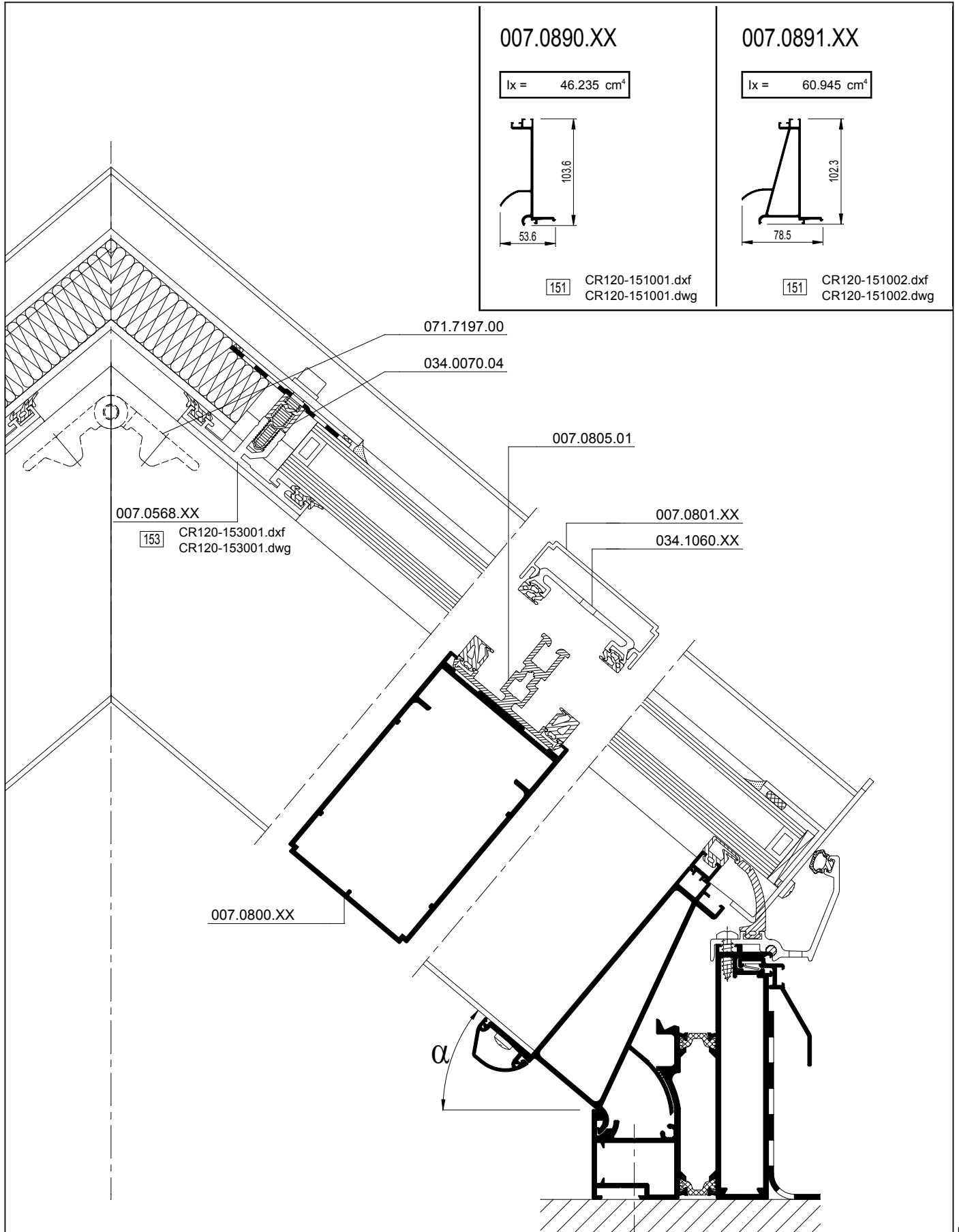
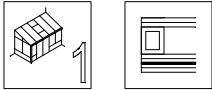



007.0800.XX

lx = 83.126 cm<sup>2</sup>

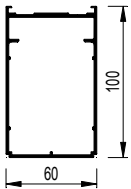

162 CR120-162001.dxf  
CR120-162001.dwg

007.0810.XX

lx = 83.820 cm<sup>2</sup>

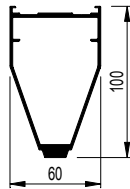

162 CR120-162002.dxf  
CR120-162002.dwg

007.0815.XX

lx = 81.450 cm<sup>2</sup>

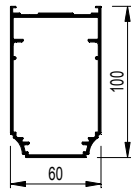

162 CR120-162003.dxf  
CR120-162003.dwg

007.0814.XX

lx = 102.598 cm<sup>2</sup>

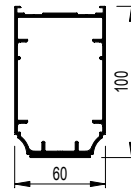

162 CR120-162004.dxf  
CR120-162004.dwg

007.0803.XX

lx = 119.471 cm<sup>2</sup>

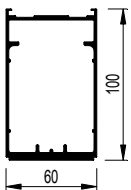

162 CR120-162005.dxf  
CR120-162005.dwg

007.0813.XX

lx = 151.075 cm<sup>2</sup>

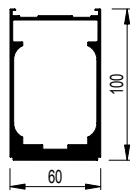

162 CR120-162006.dxf  
CR120-162006.dwg

071.6871.XX

0L3.0302.XX

007.1894.XX

080.9452.04

021.5146.07

022.3036.04

007.0853.XX

034.0618.XX

161

162

5° < α < 25° (007.0892.XX)

25° < α < 45° (007.0893.XX)

007.0893.XX

007.0852.XX

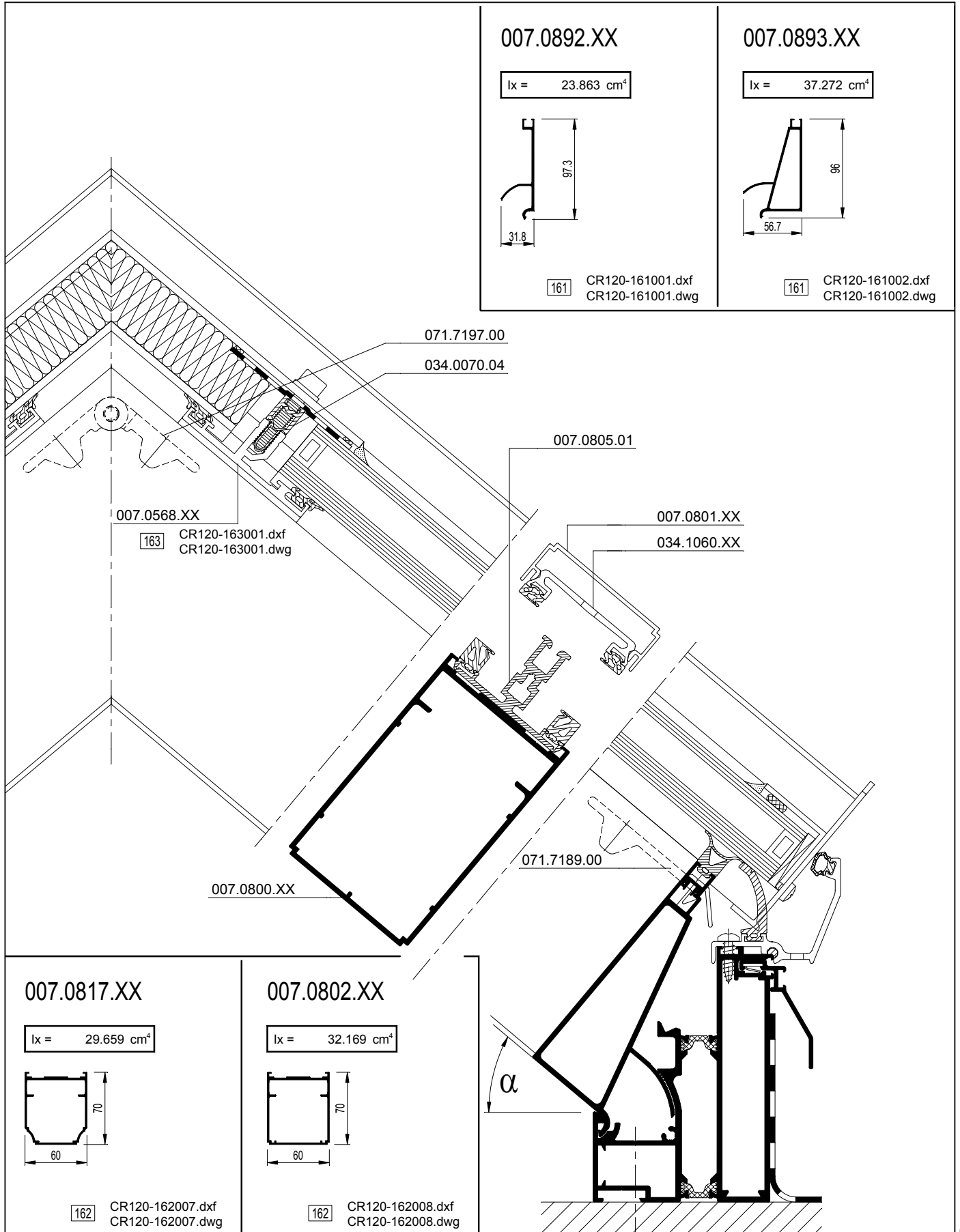



007.0800.XX

$I_x = 83.126 \text{ cm}^4$

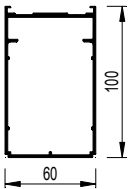

172 CR120-172001.dxf  
CR120-172001.dwg

007.0810.XX

$I_x = 83.820 \text{ cm}^4$

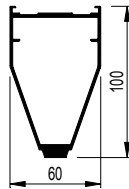

172 CR120-172002.dxf  
CR120-172002.dwg

007.0815.XX

$I_x = 81.450 \text{ cm}^4$

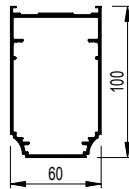

172 CR120-172003.dxf  
CR120-172003.dwg

007.0814.XX

$I_x = 102.598 \text{ cm}^4$

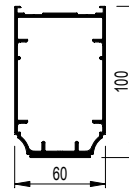

172 CR120-172004.dxf  
CR120-172004.dwg

007.0803.XX

$I_x = 119.471 \text{ cm}^4$

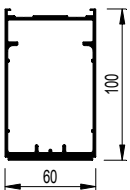

172 CR120-172005.dxf  
CR120-172005.dwg

007.0813.XX

$I_x = 151.075 \text{ cm}^4$

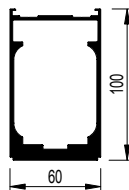

172 CR120-172006.dxf  
CR120-172006.dwg

$5^\circ < \alpha < 45^\circ$

007.0798.XX

$I_x = 186.767 \text{ cm}^4$

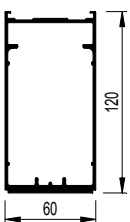

172 CR120-172007.dxf  
CR120-172007.dwg

007.0799.XX

$I_x = 499.551 \text{ cm}^4$

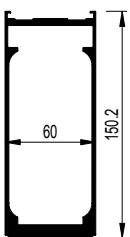

172 CR120-172008.dxf  
CR120-172008.dwg

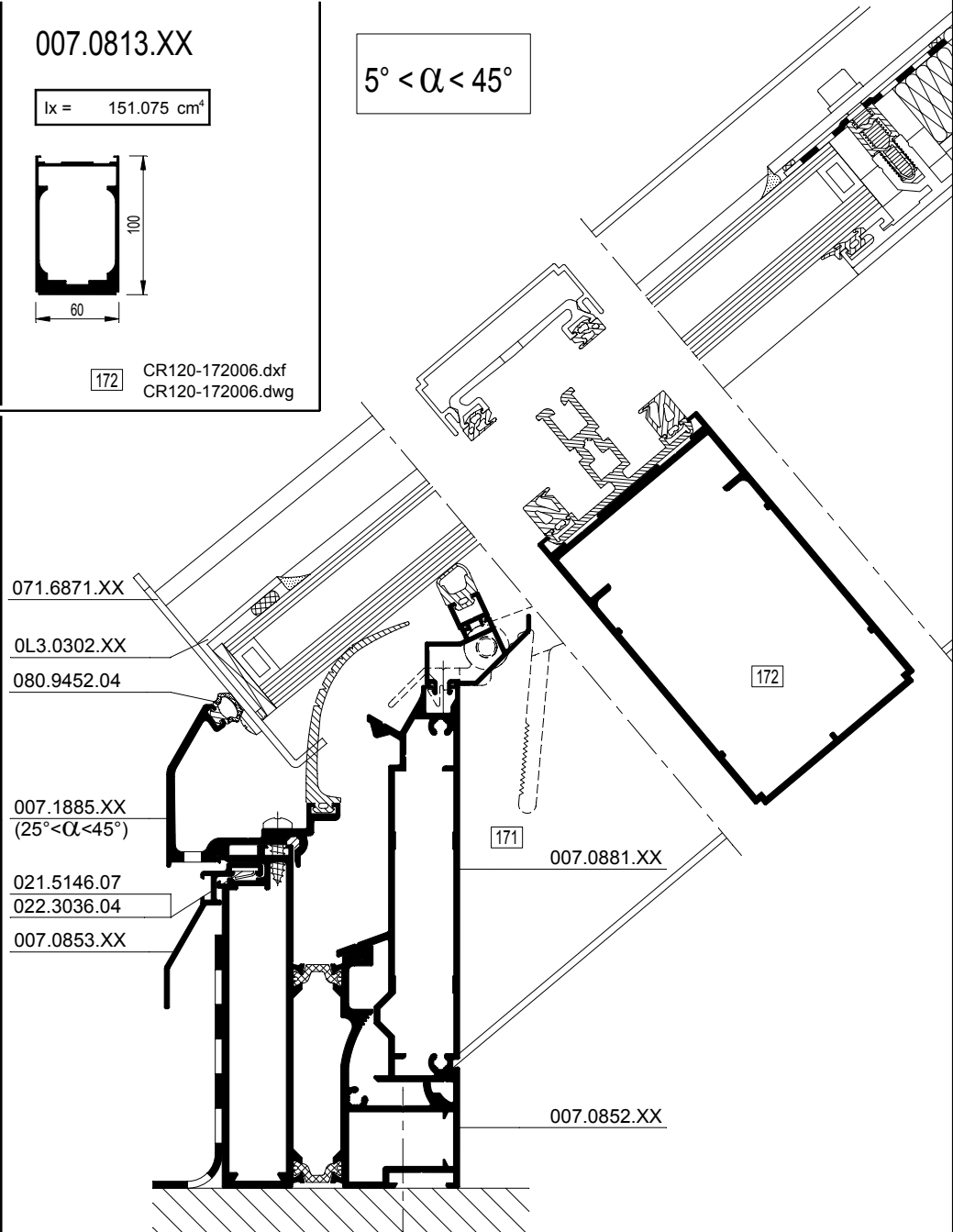

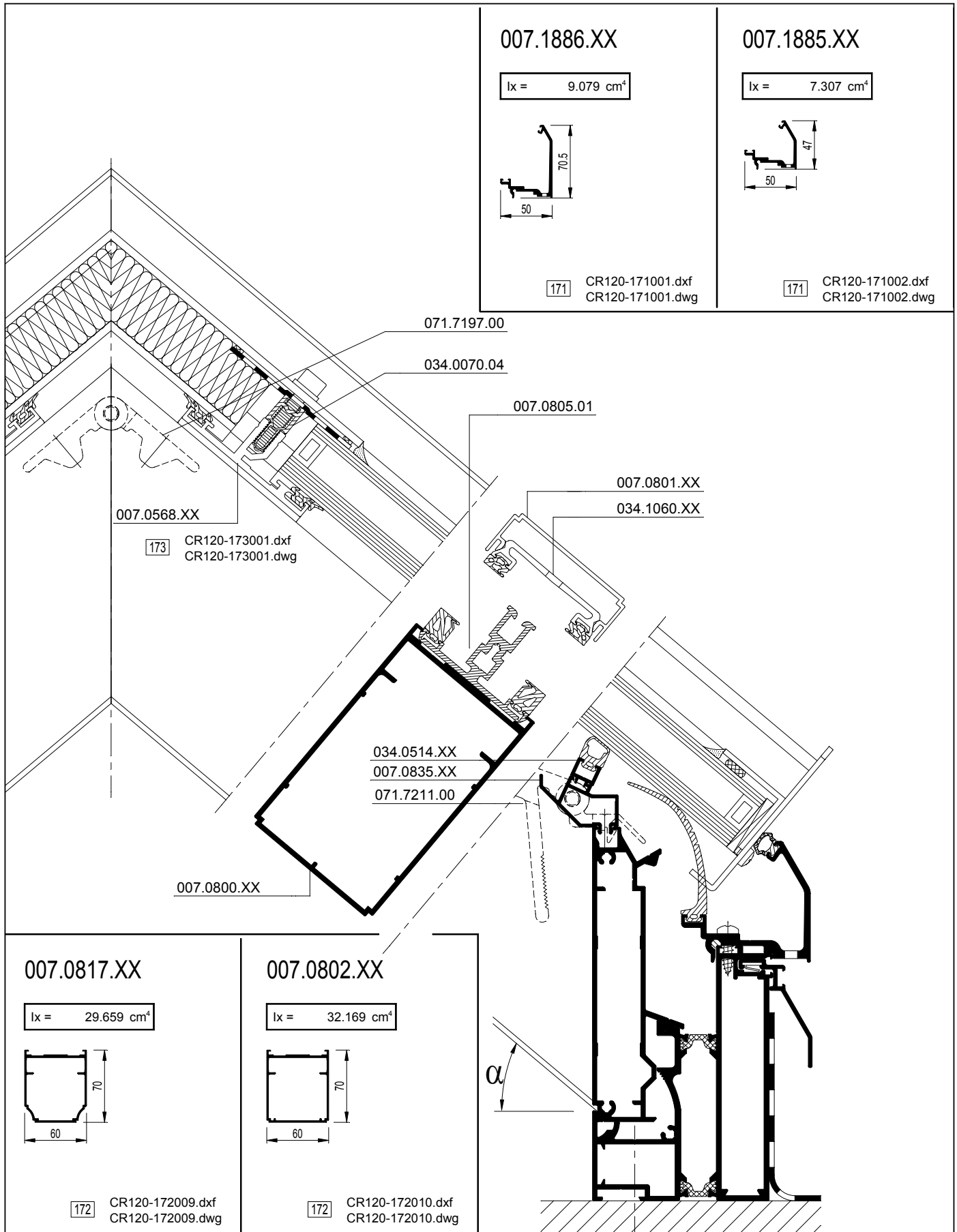

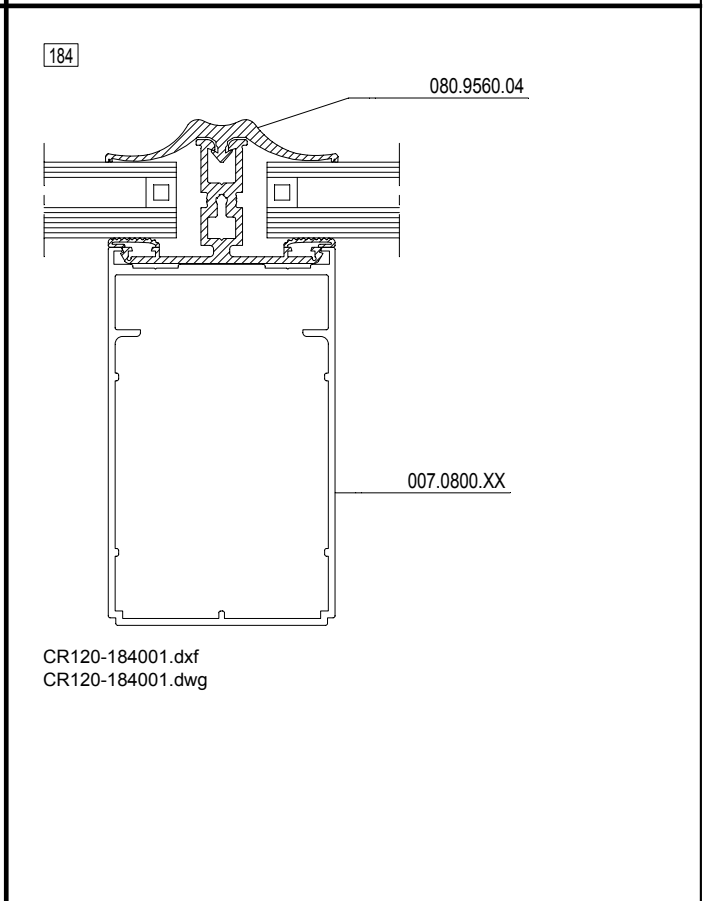
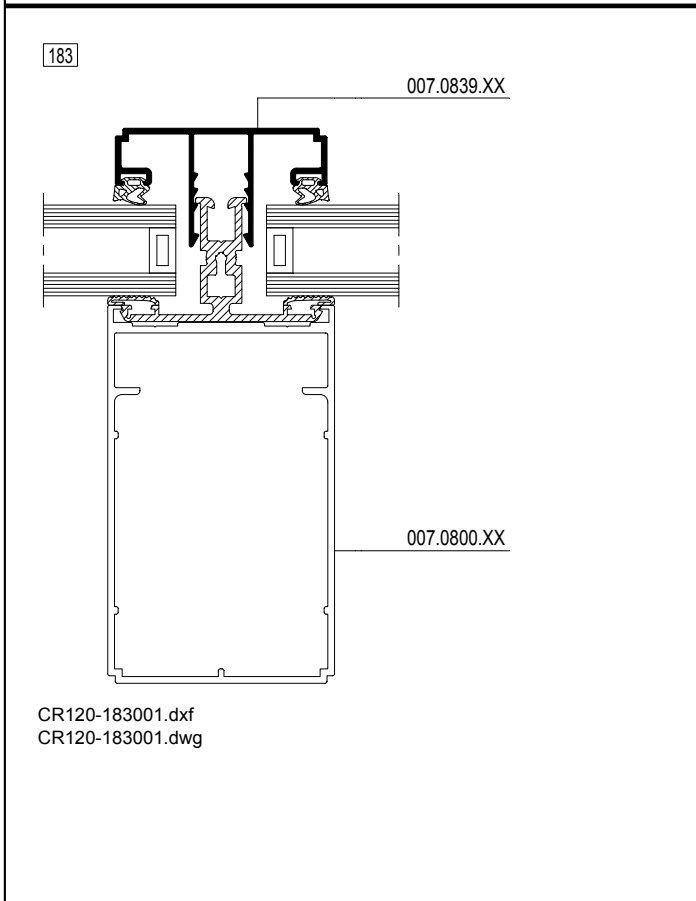
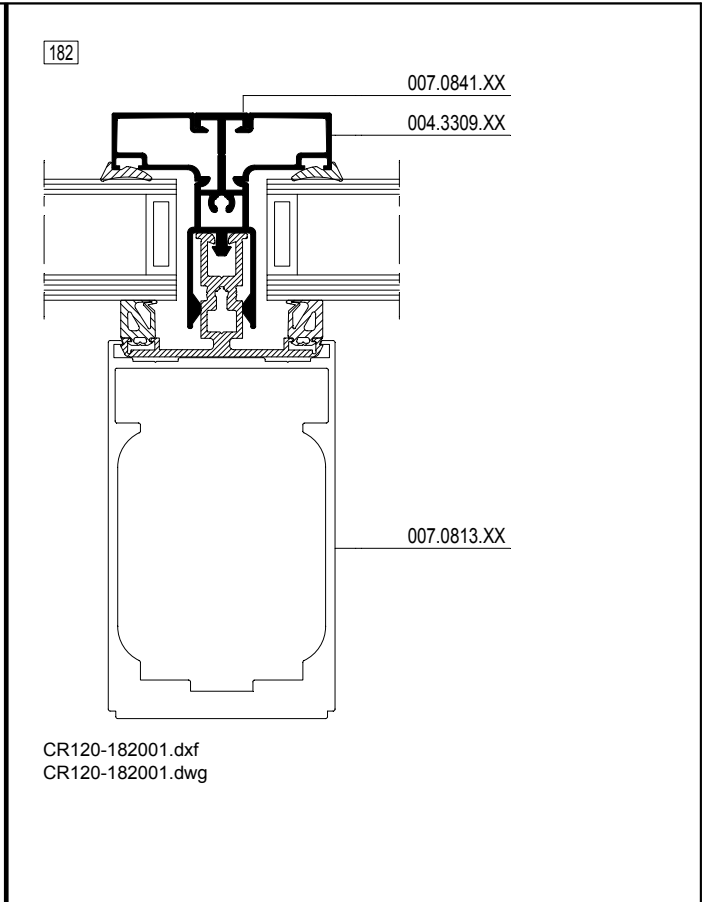
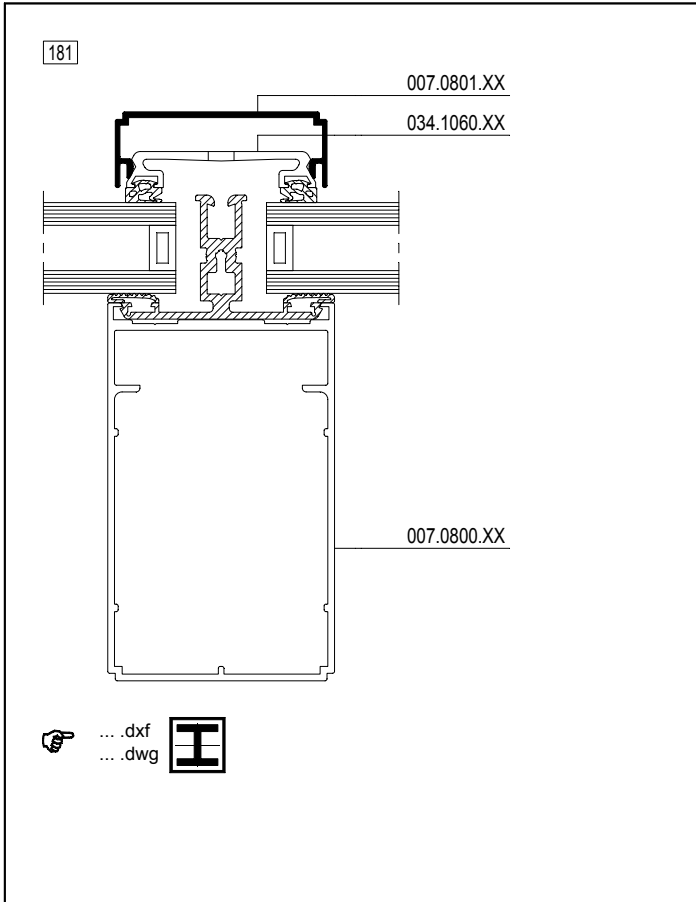





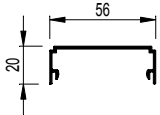

007.0801.XX

$I_x = 0.582 \text{ cm}^4$



 CR120-181001.dxf  
CR120-181001.dwg

007.0811.XX

$I_x = 0.532 \text{ cm}^4$

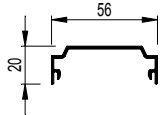

 CR120-181002.dxf  
CR120-181002.dwg

007.0816.XX

$I_x = 0.538 \text{ cm}^4$

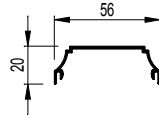

 CR120-181003.dxf  
CR120-181003.dwg

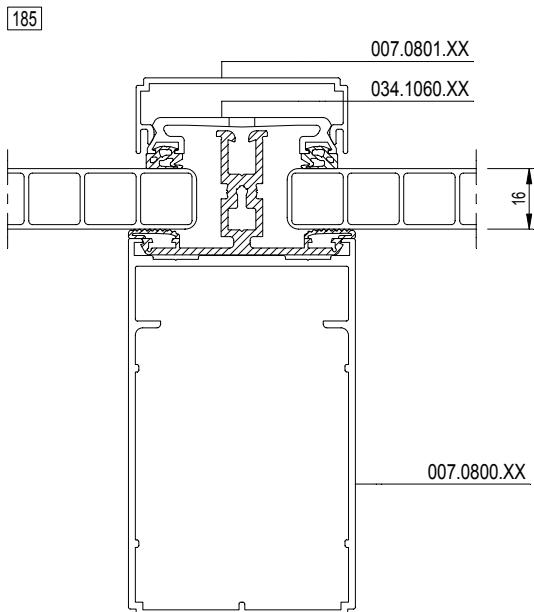

... .dxf  
 ... .dwg

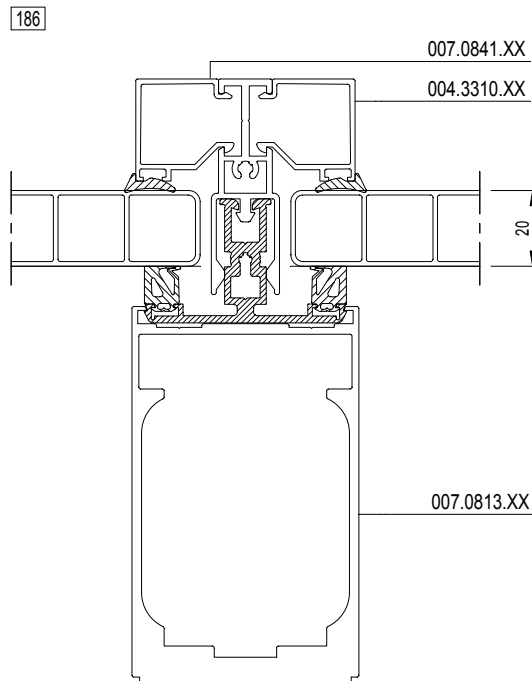

CR120-186001.dxf  
 CR120-186001.dwg

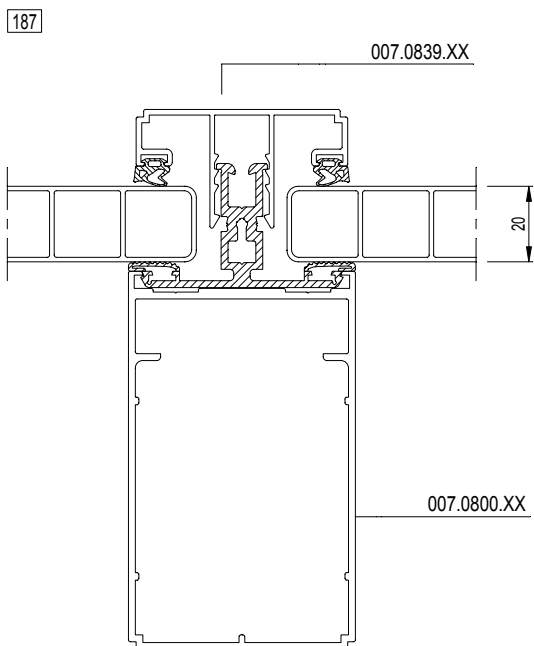

CR120-187001.dxf  
 CR120-187001.dwg

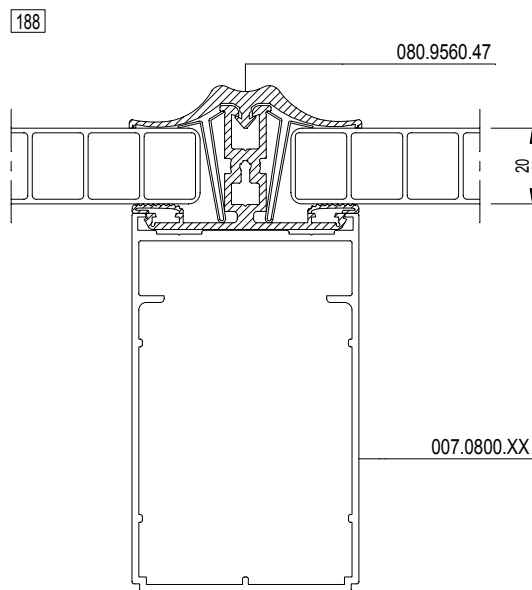



CR120-188001.dxf  
 CR120-188001.dwg

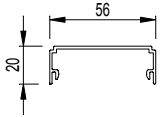

007.0801.XX

$I_x = 0.582 \text{ cm}^4$



 CR120-185001.dxf  
CR120-185001.dwg

007.0811.XX

$I_x = 0.532 \text{ cm}^4$

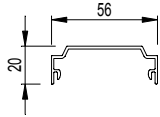

 CR120-185002.dxf  
CR120-185002.dwg

007.0816.XX

$I_x = 0.538 \text{ cm}^4$

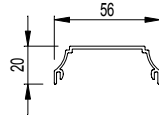

 CR120-185003.dxf  
CR120-185003.dwg

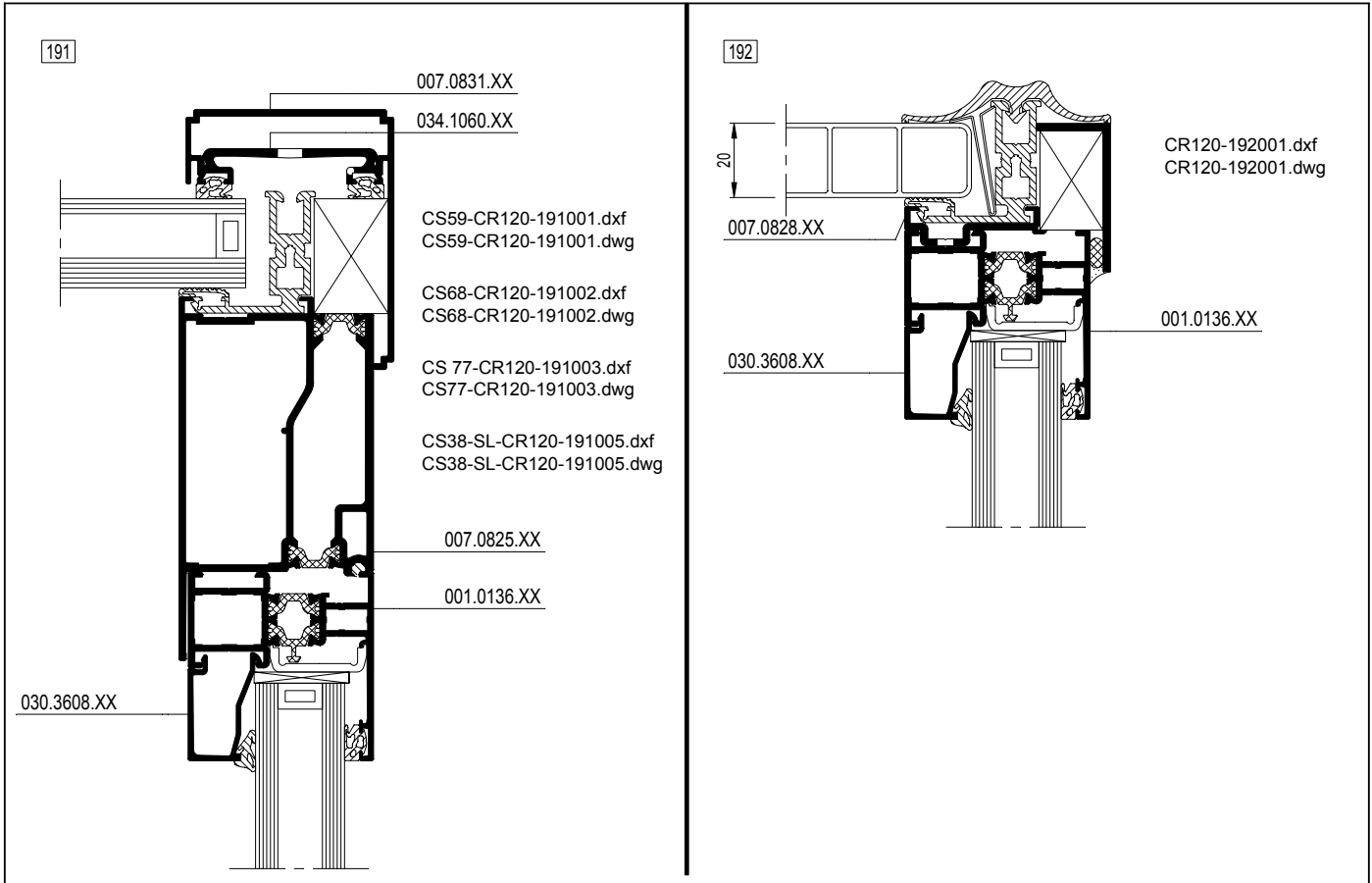



193

CR120-193001.dxf  
CR120-193001.dwg

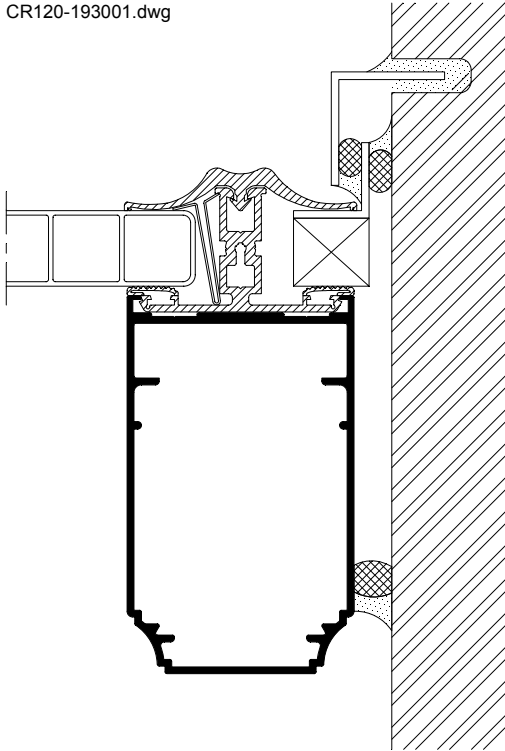

194

CR120-194001.dxf  
CR120-194001.dwg

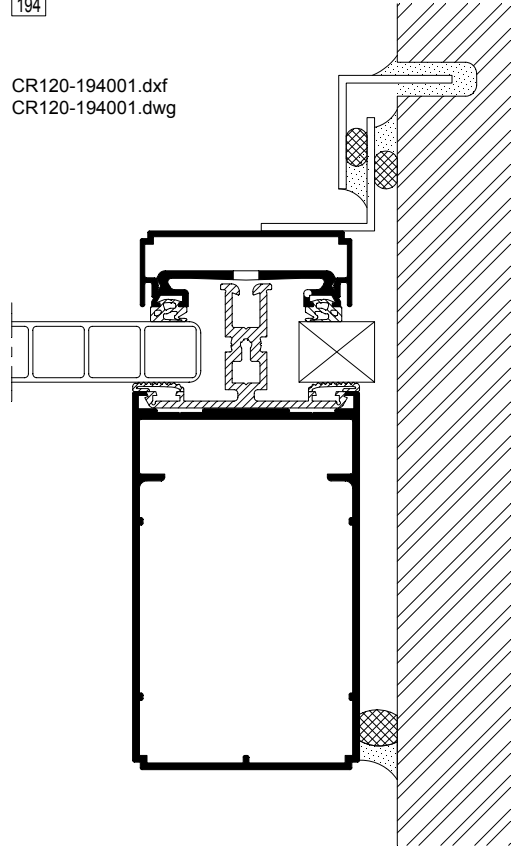

195

CR120-195001.dxf  
CR120-195001.dwg

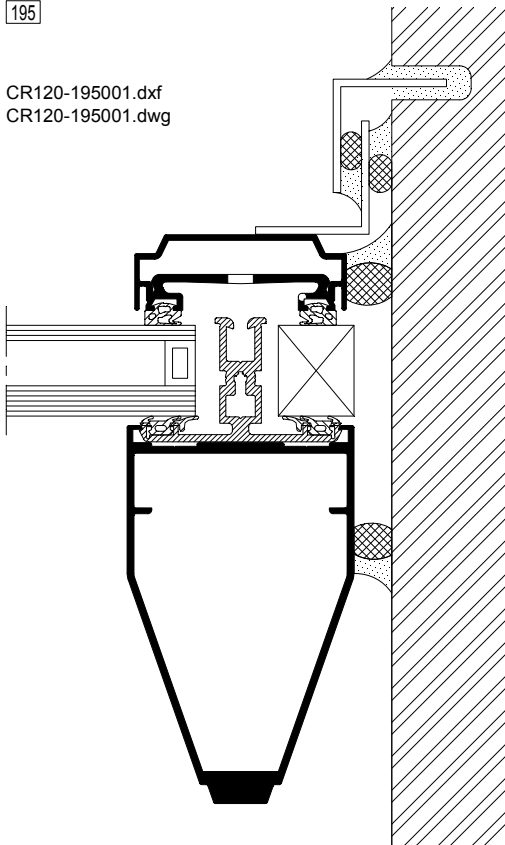

196

CR120-196001.dxf  
CR120-196001.dwg

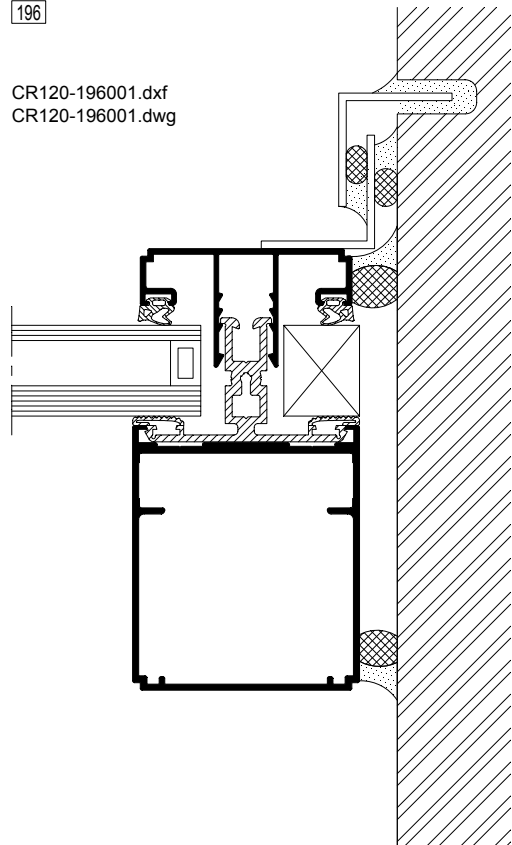

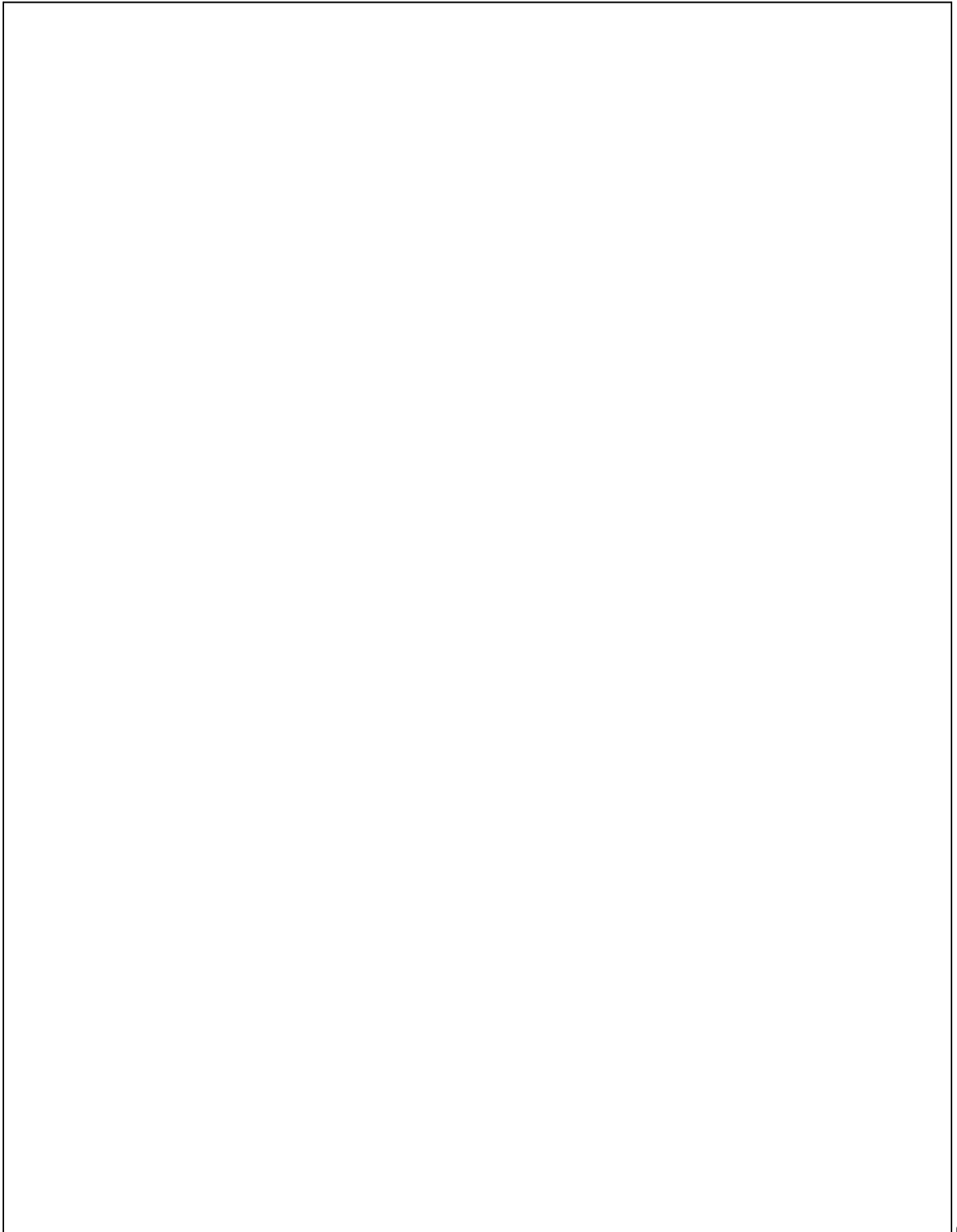

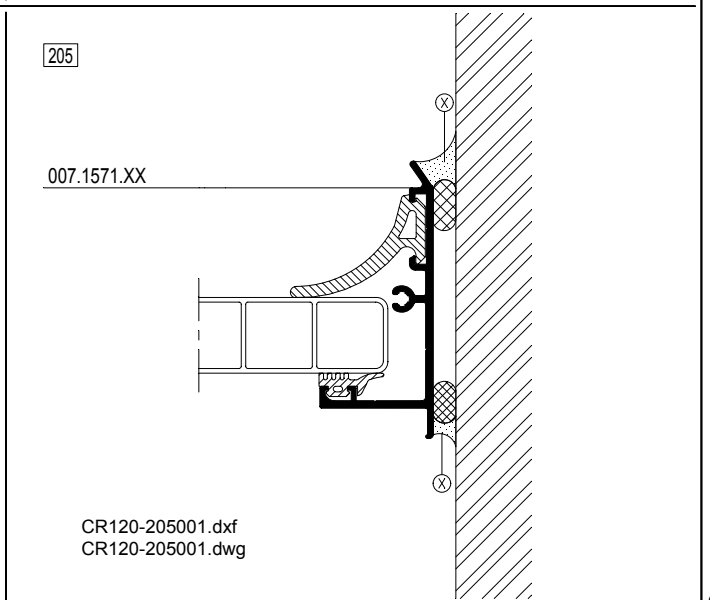
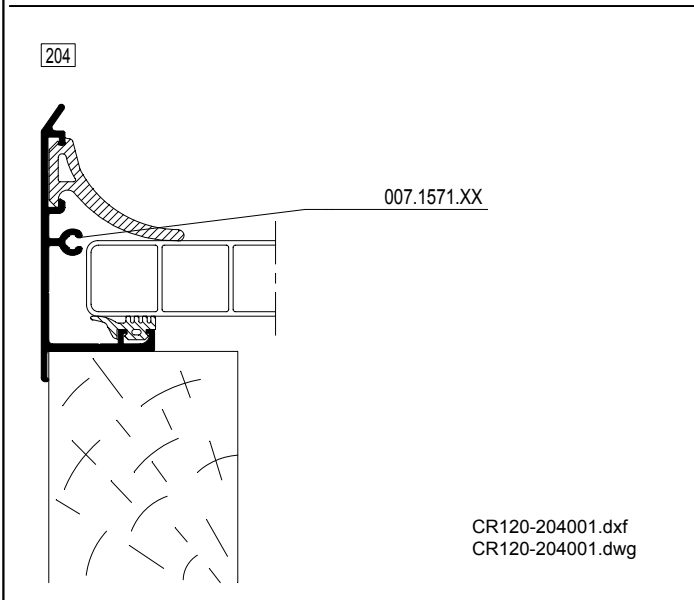
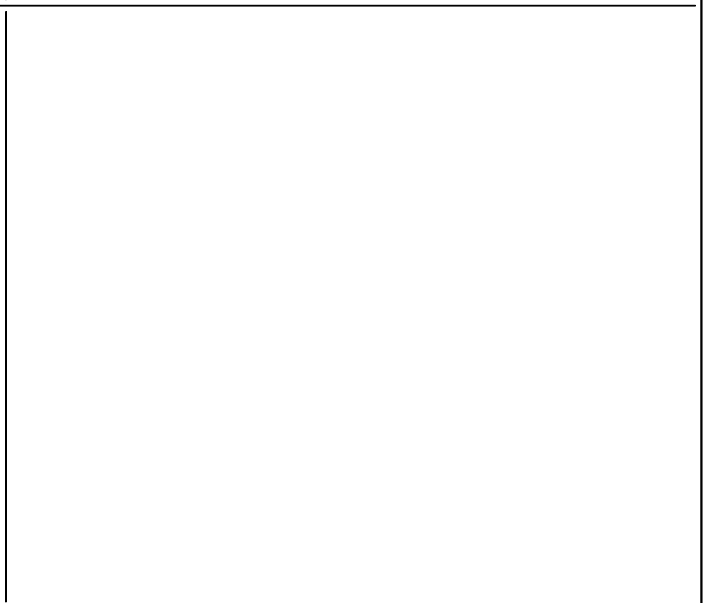
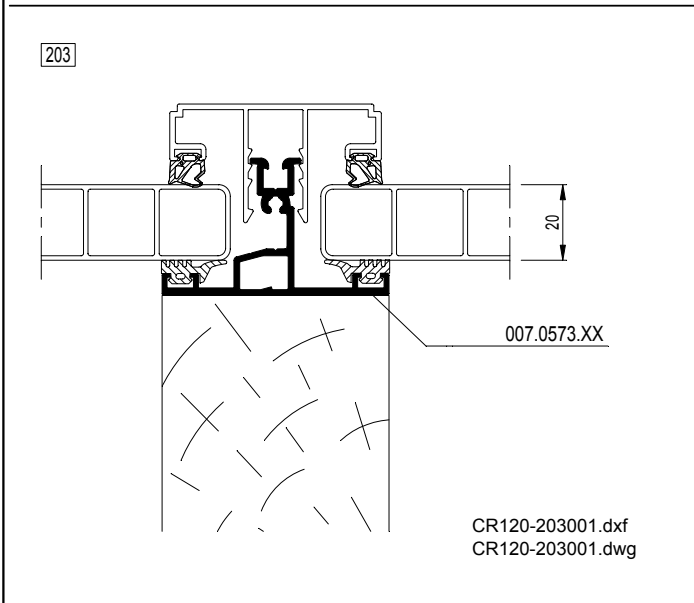
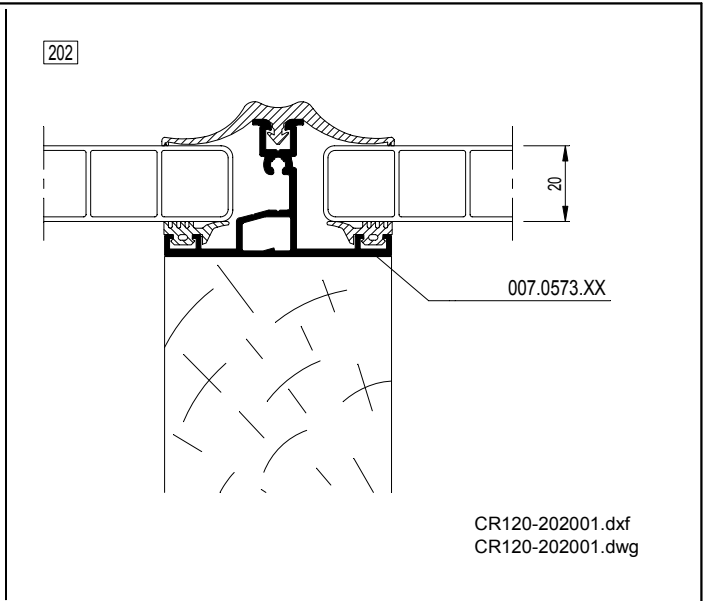
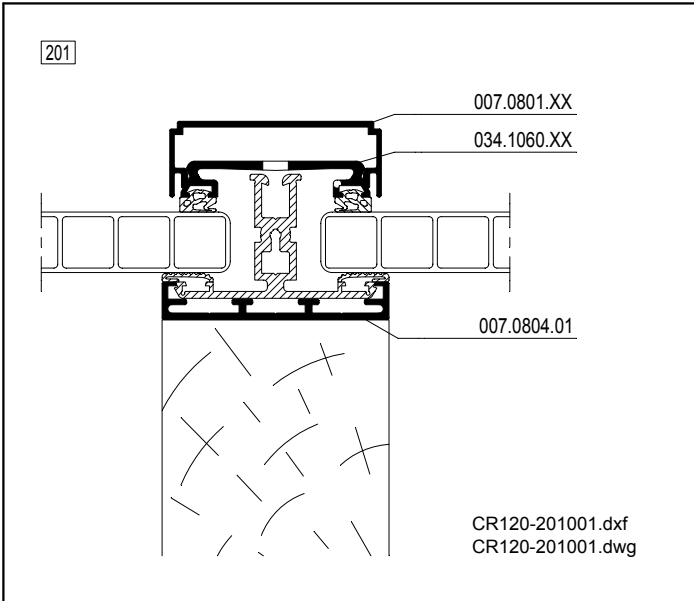



211

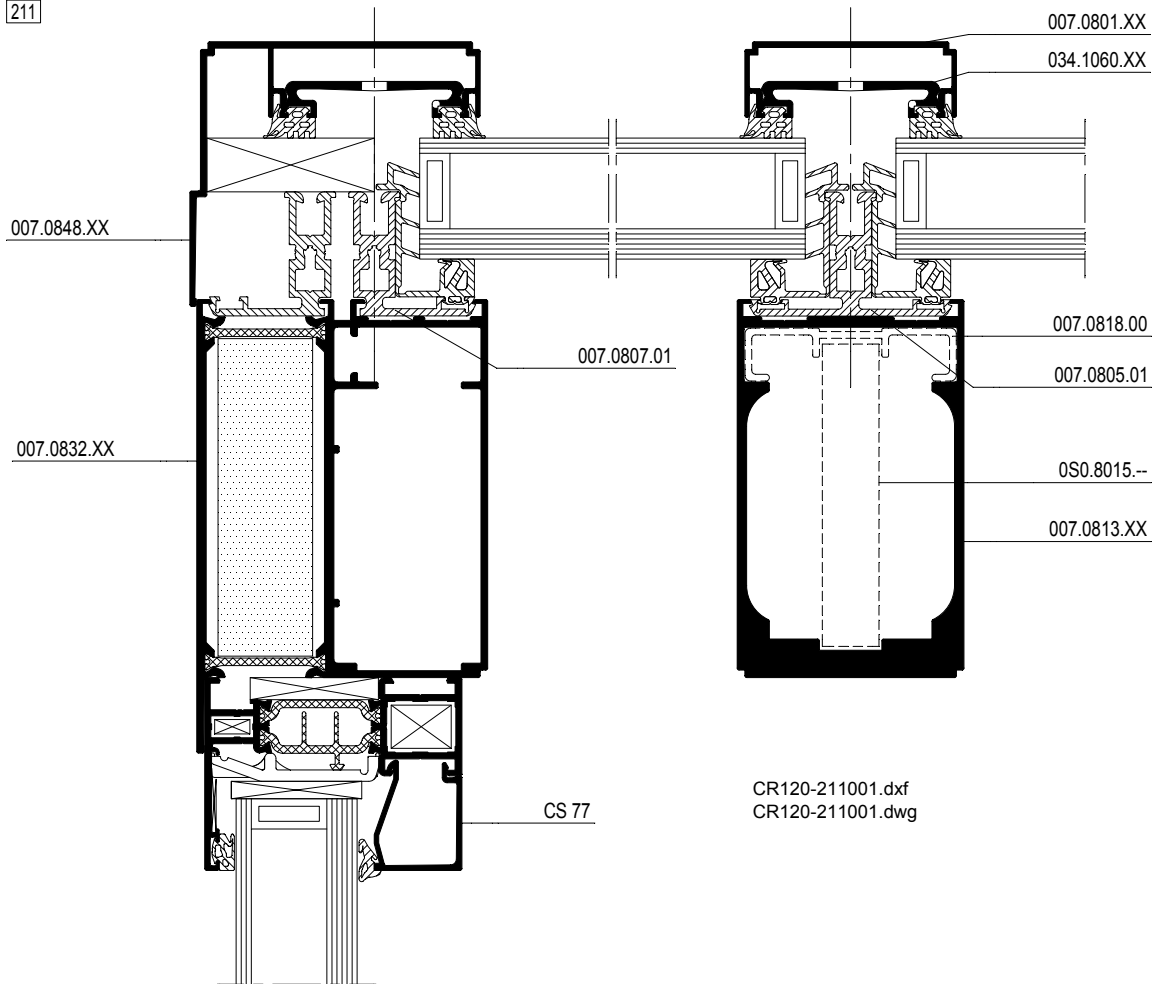





212

007.0841.XX

007.0806.01

007.0846.XX

007.0832.XX

004.3309.XX

0S8.0405.--

007.0813.XX

CS 77

CR120-212001.dxf  
CR120-212001.dwg



213

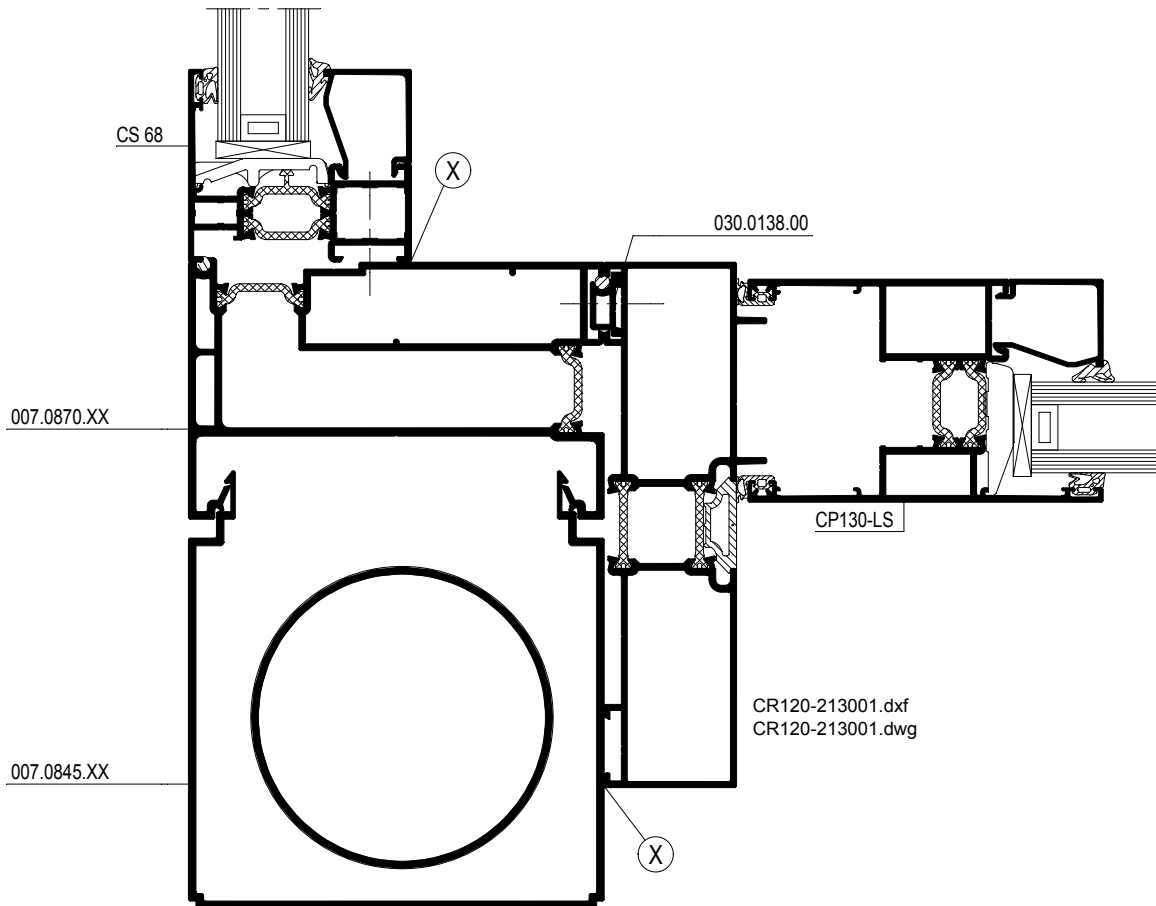



214

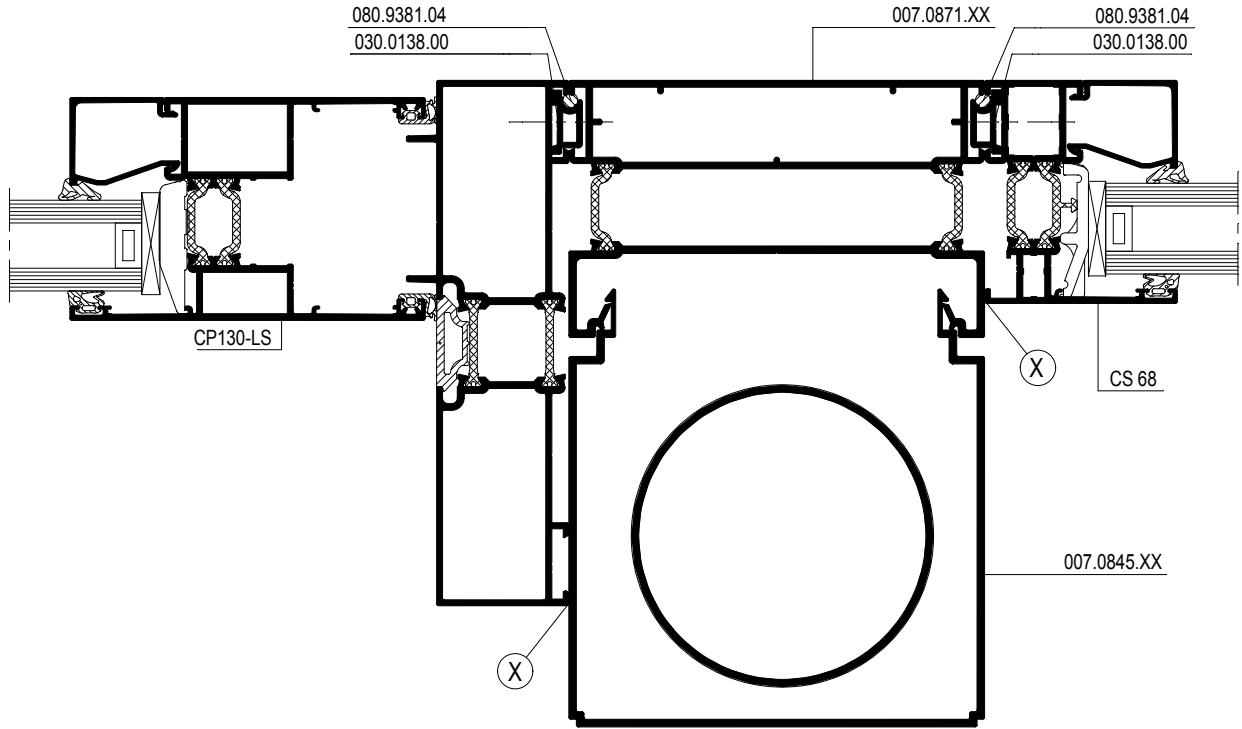

CR120-214001.dxf  
CR120-214001.dwg

215

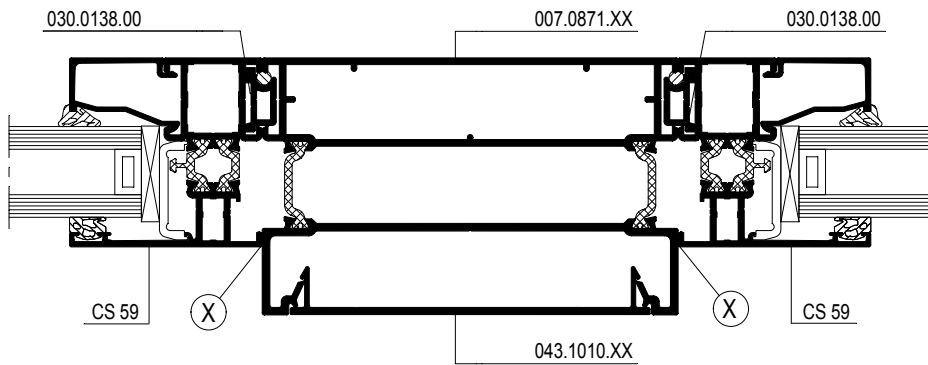

CR120-215001.dxf  
CR120-215001.dwg



216

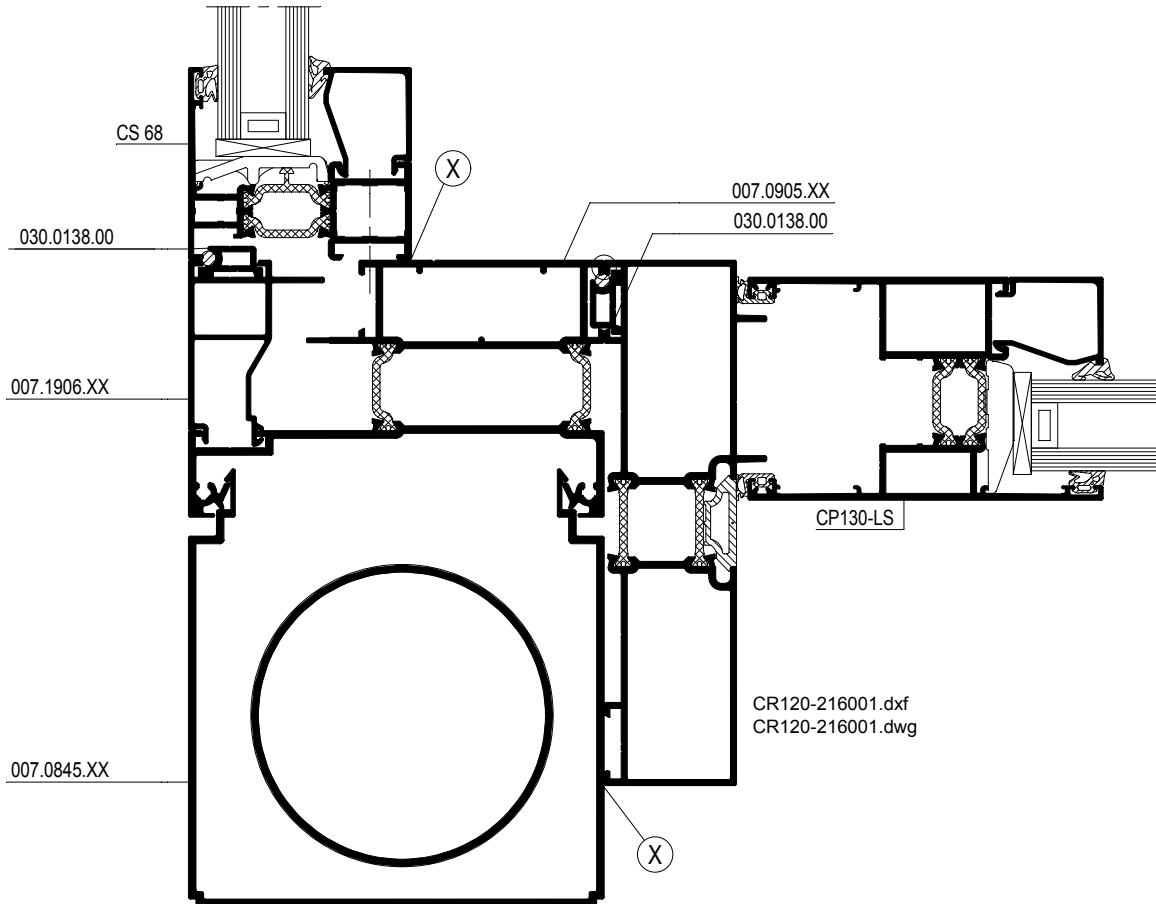



217

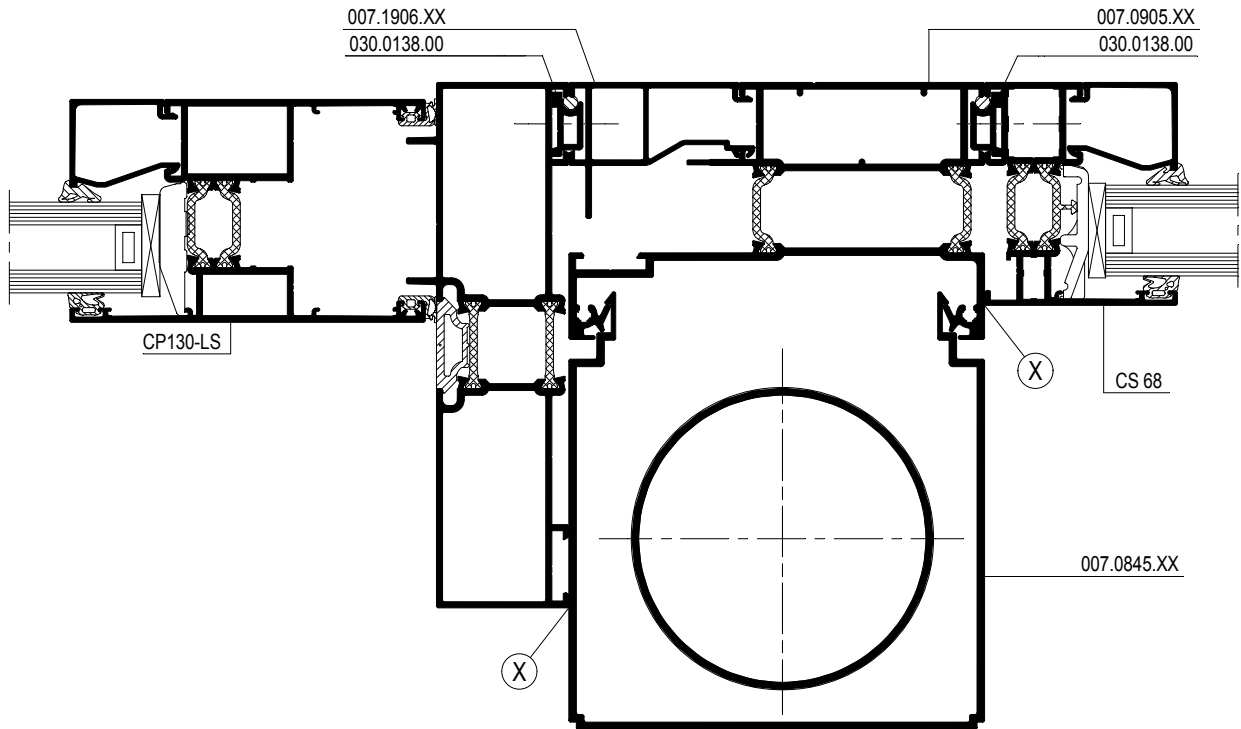

CR120-217001.dxf  
CR120-217001.dwg

218

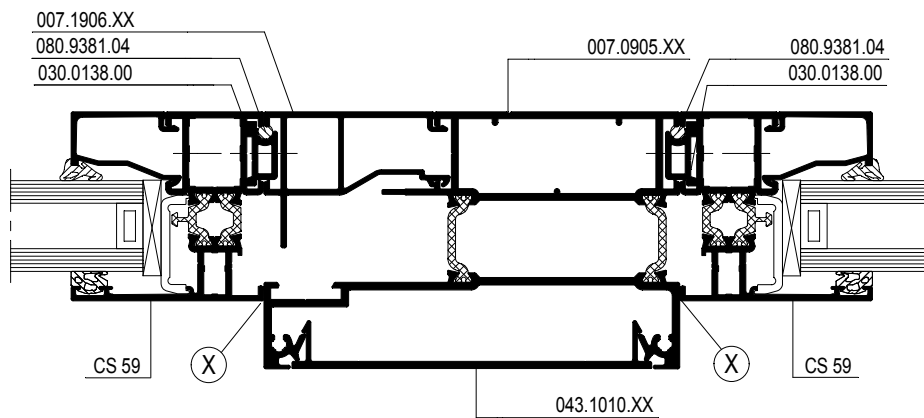

CR120-218001.dxf  
CR120-218001.dwg



221

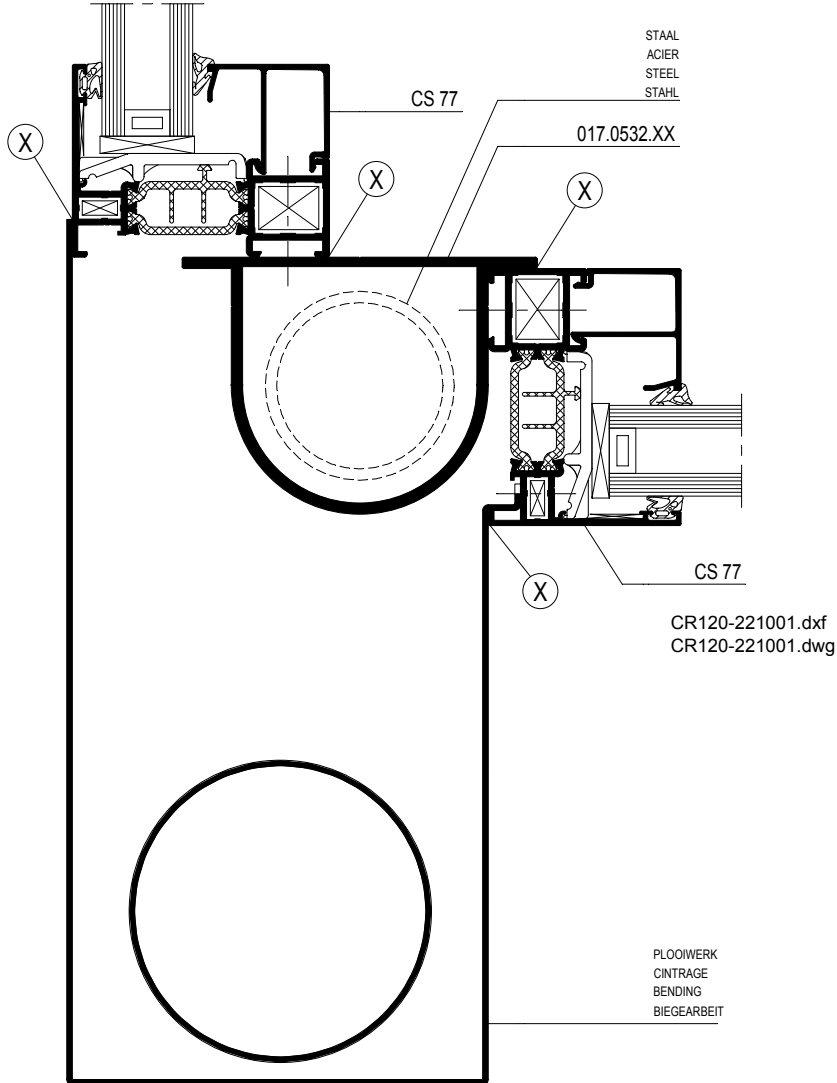



222

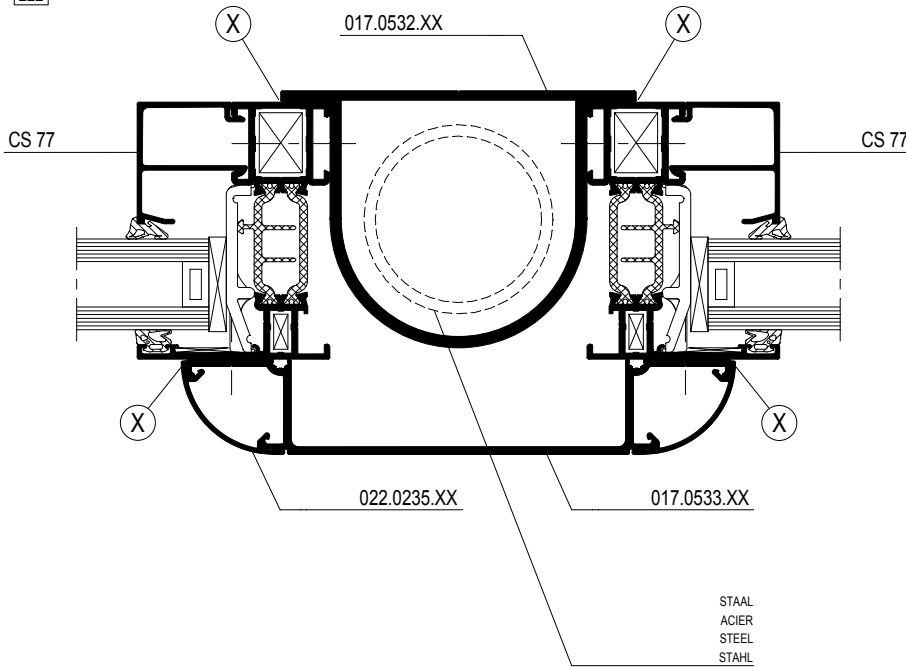

CR120-222001.dxf  
CR120-222001.dwg



223

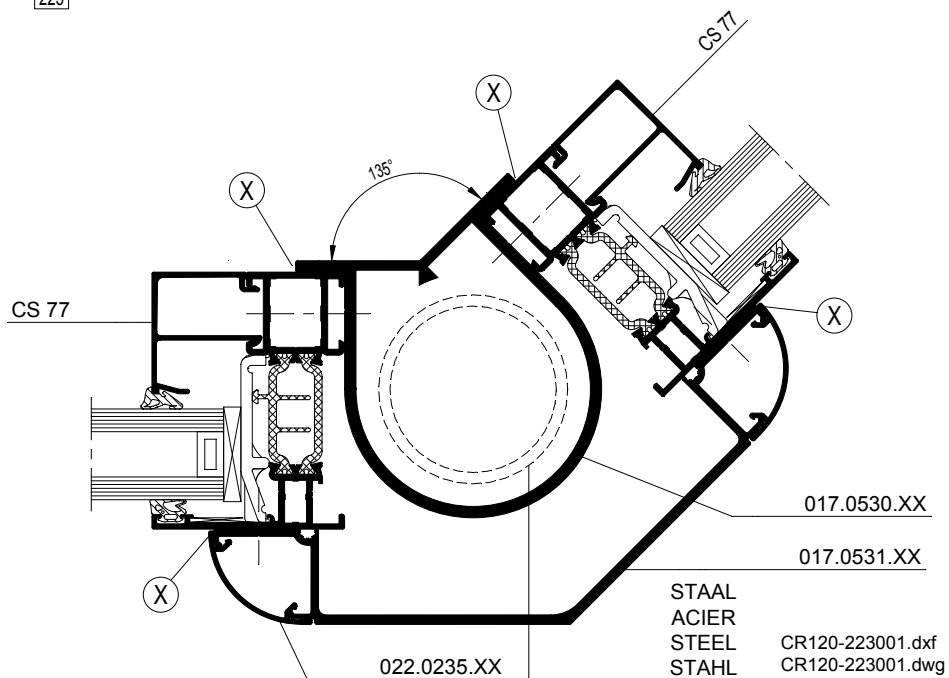

224

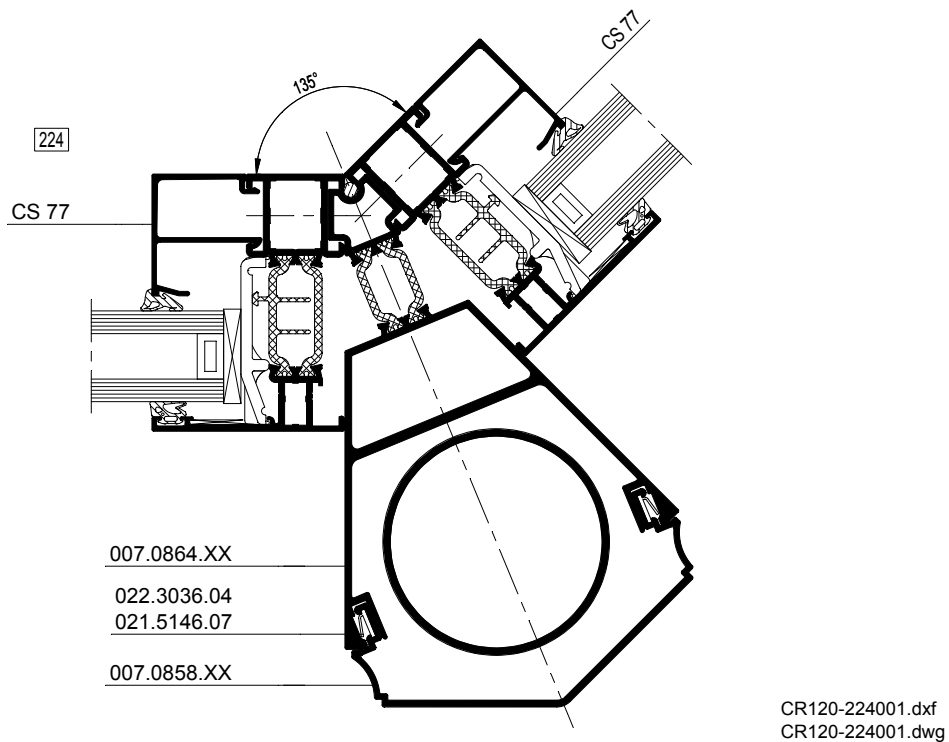





225

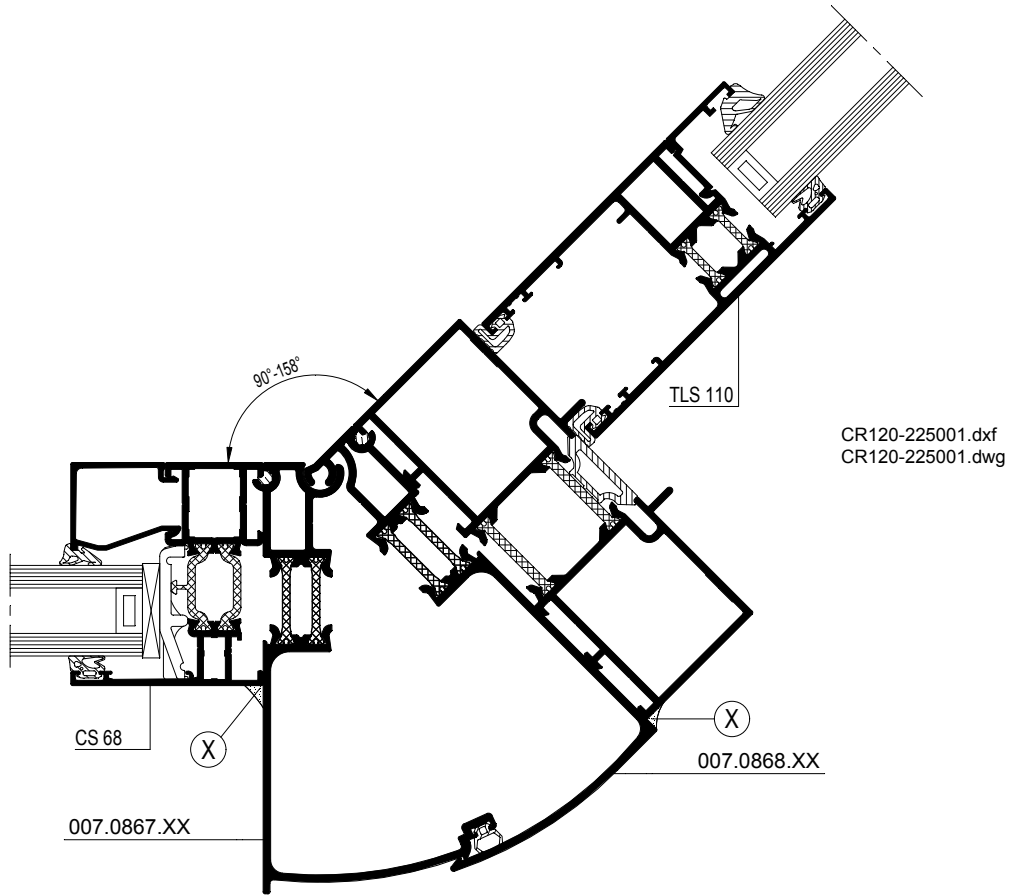

226

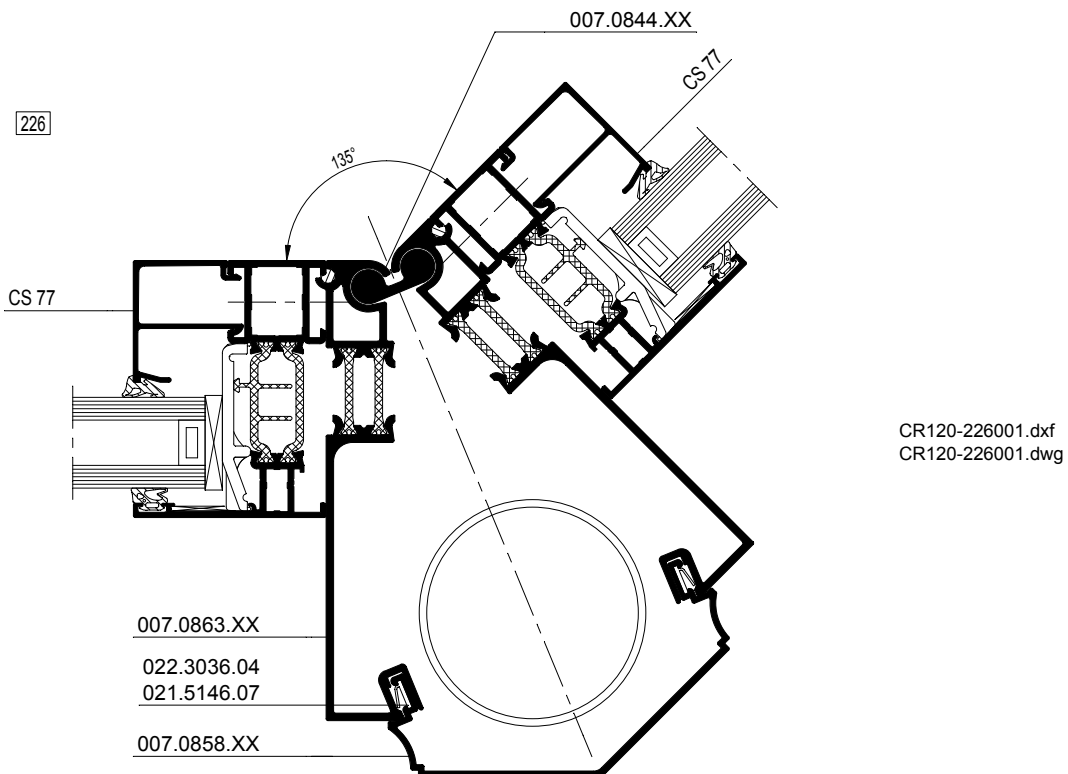



231

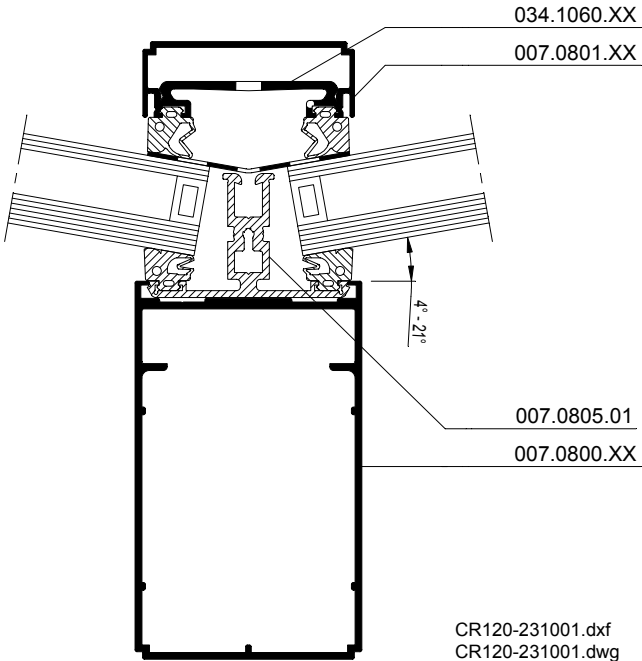

$5^\circ < \alpha < 30^\circ$

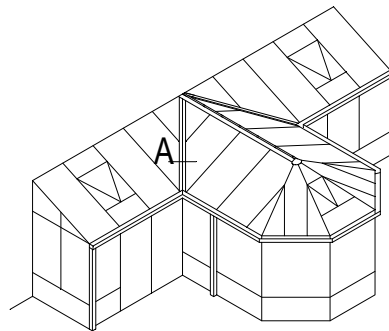

232

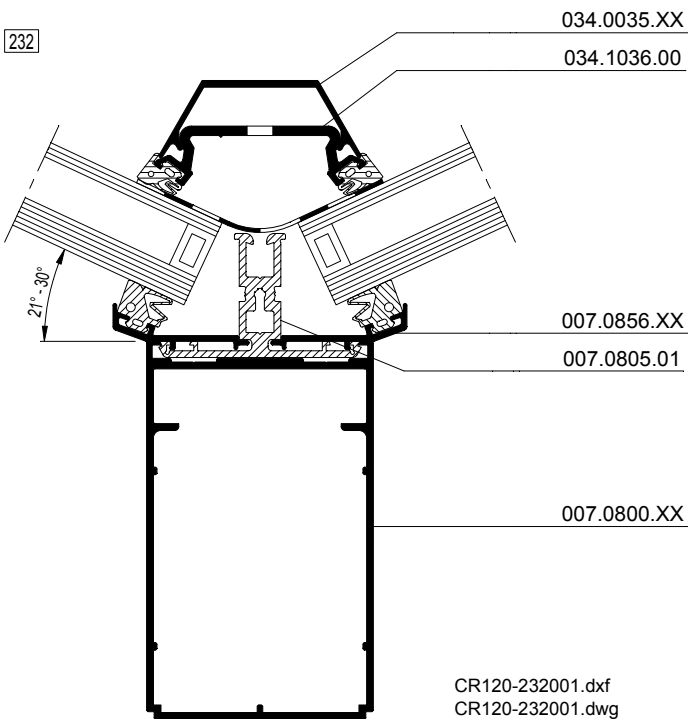

$30^\circ < \alpha < 45^\circ$



233

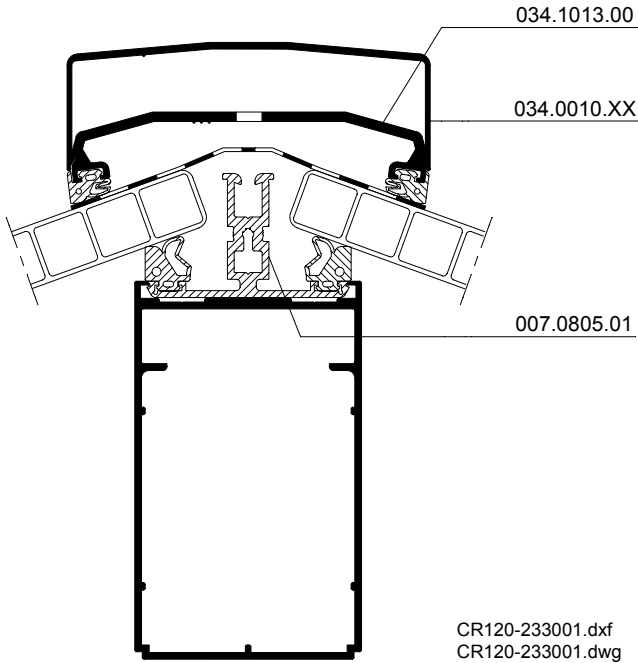

$5^\circ < \alpha < 45^\circ$

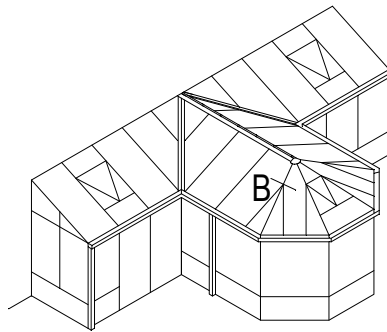
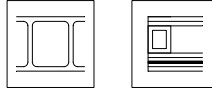

234

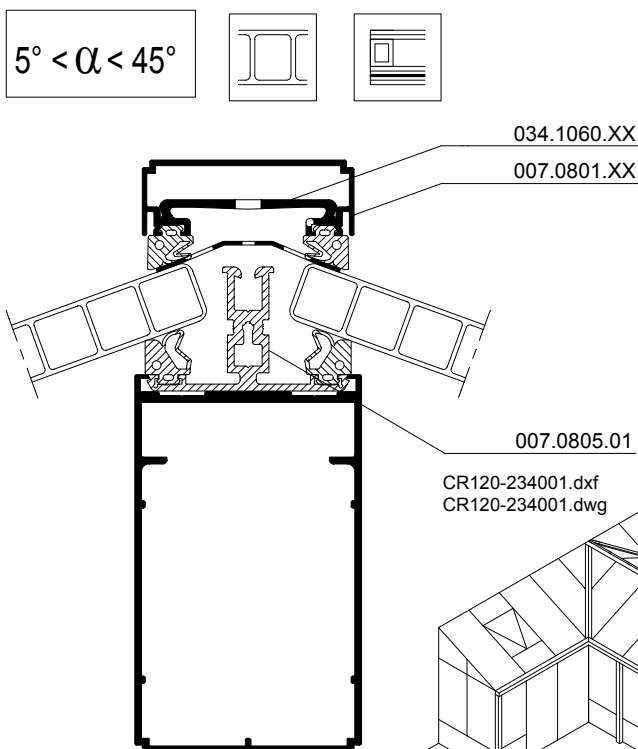

235

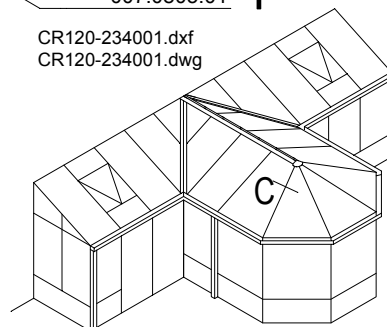
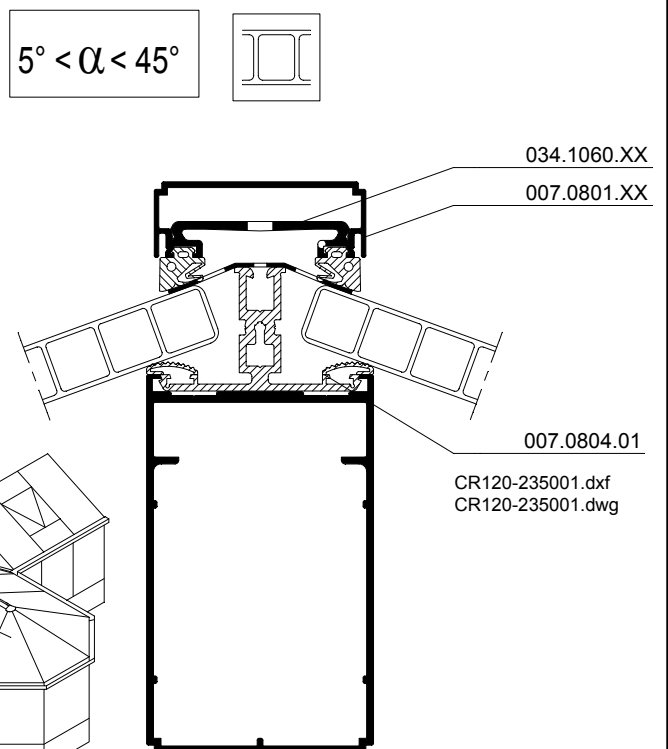

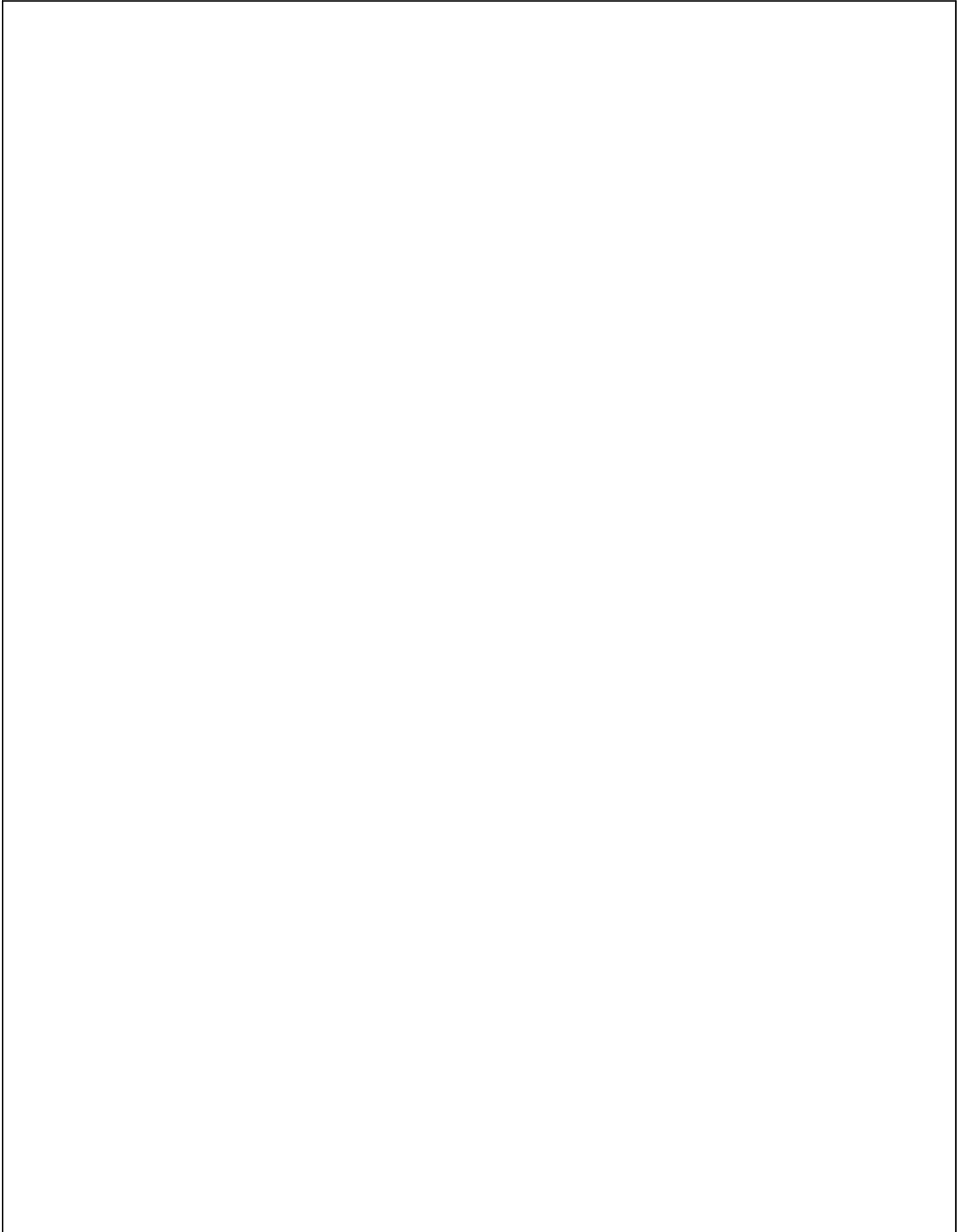



241

D

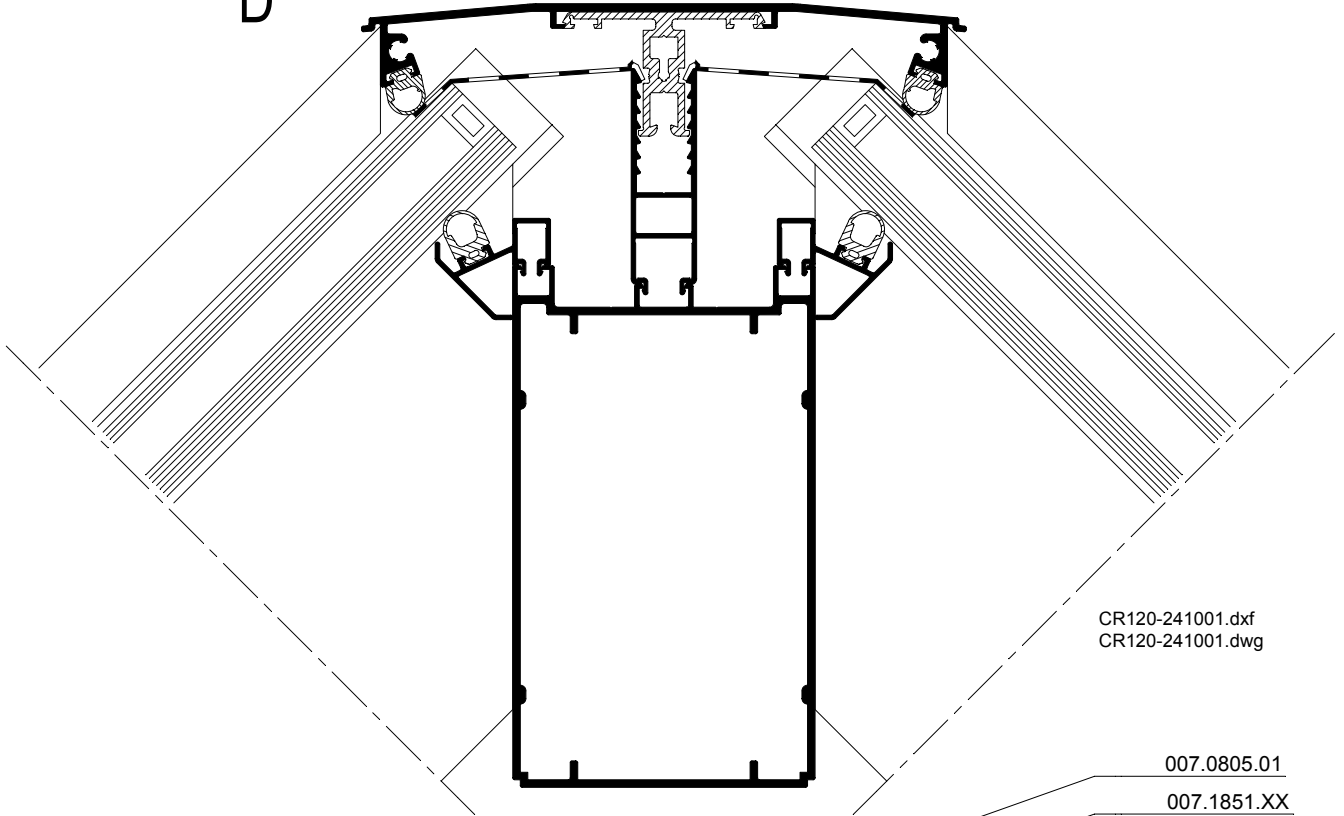

CR120-241001.dxf  
CR120-241001.dwg

007.0805.01

007.1851.XX

007.0838.00

242

D

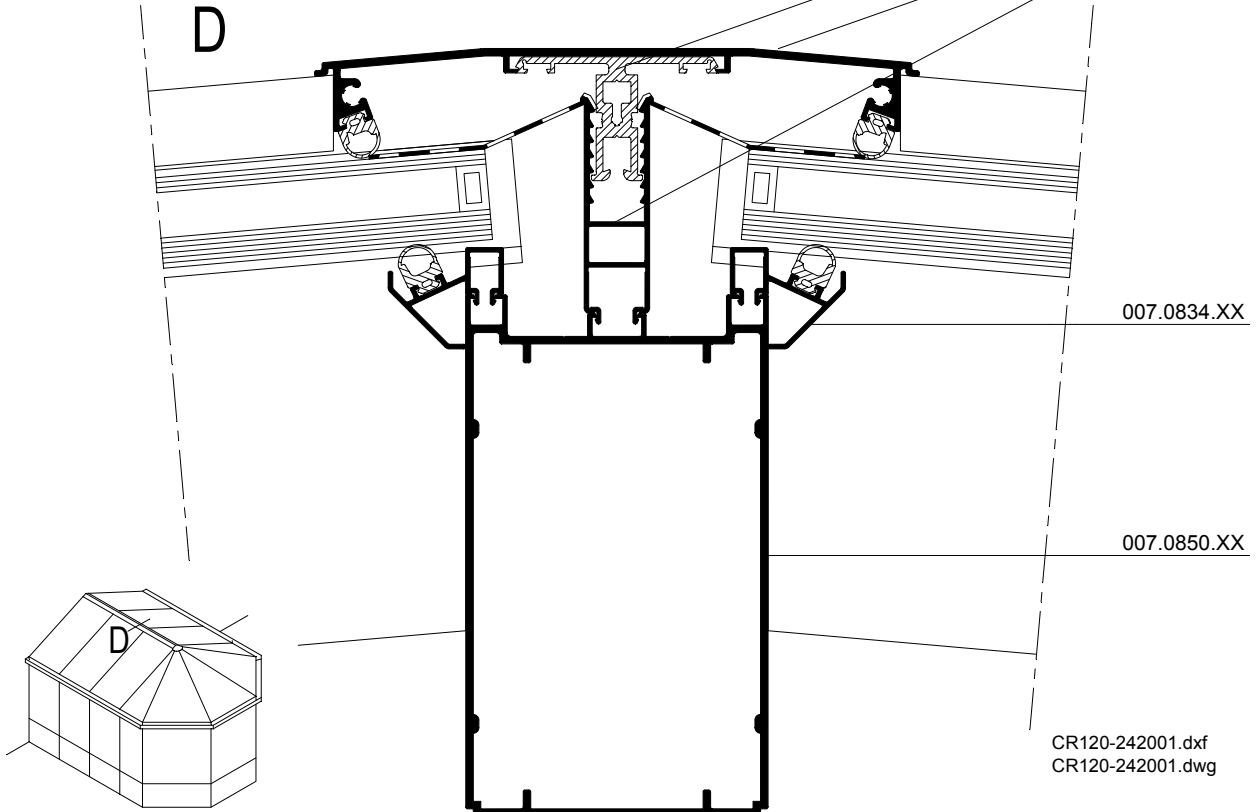

007.0834.XX

007.0850.XX

CR120-242001.dxf  
CR120-242001.dwg



251

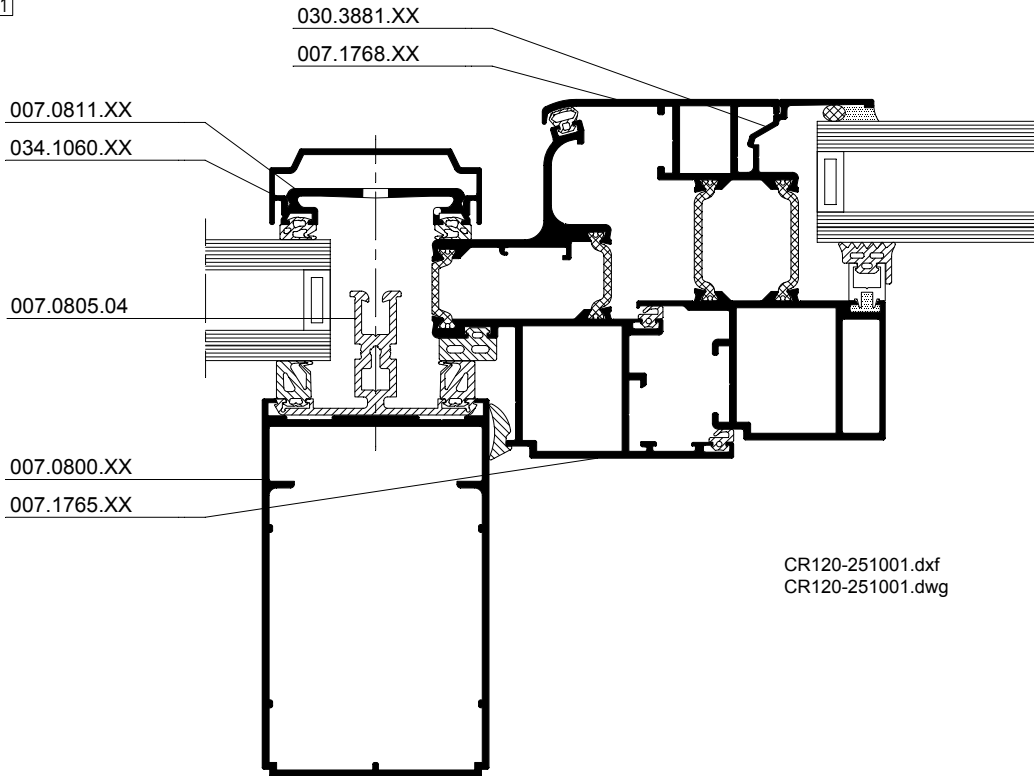

252

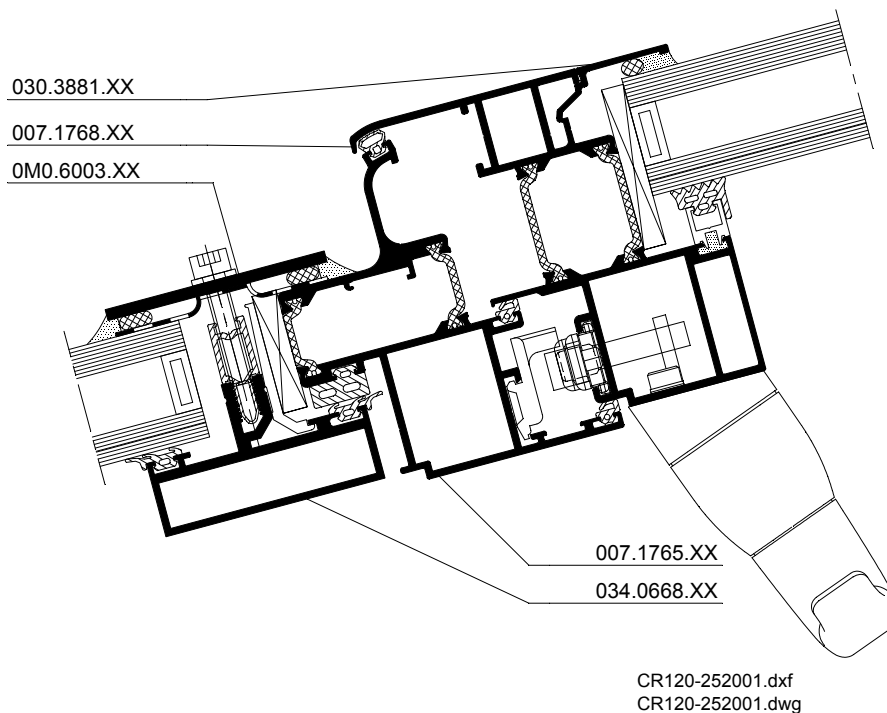



252

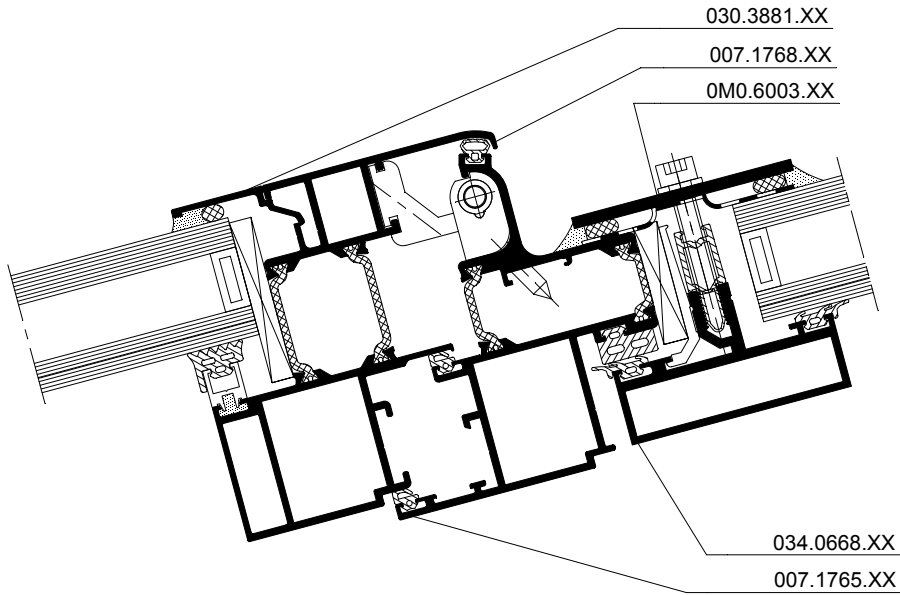

CR120-252002.dxf  
CR120-252002.dwg



251

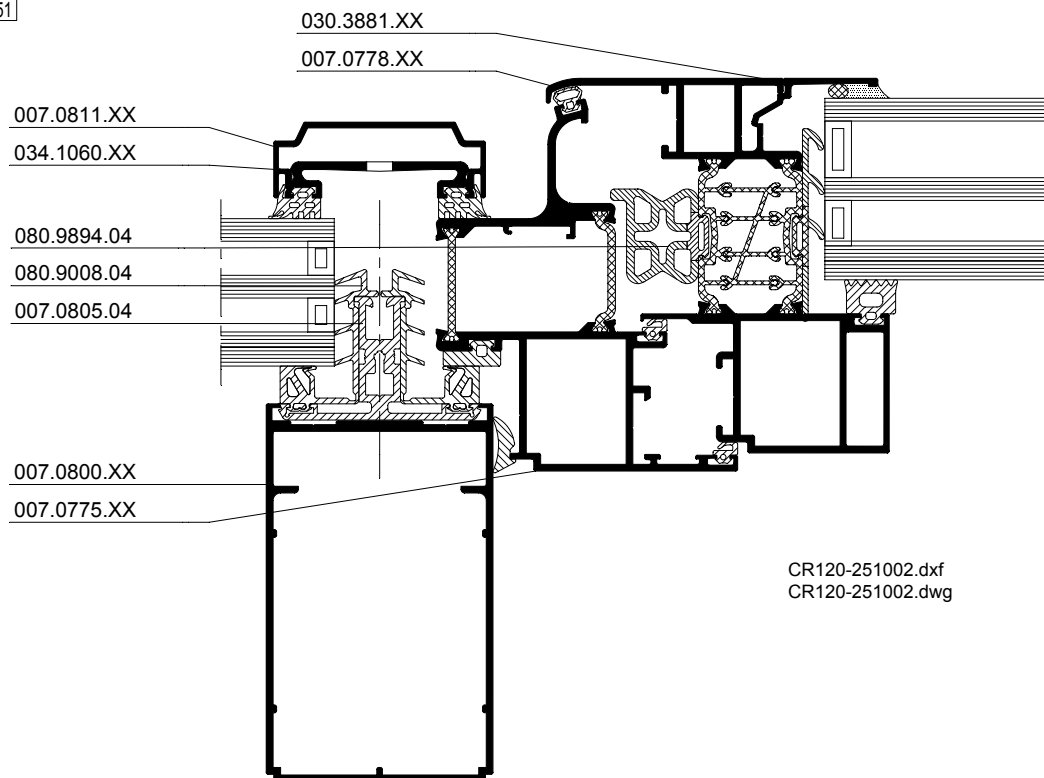

252

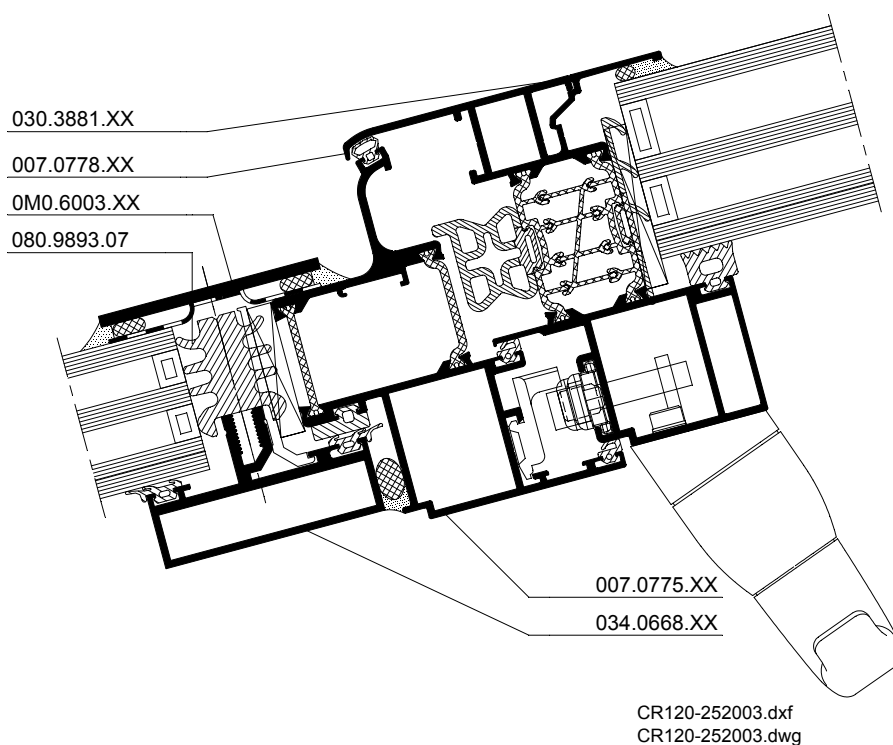





252

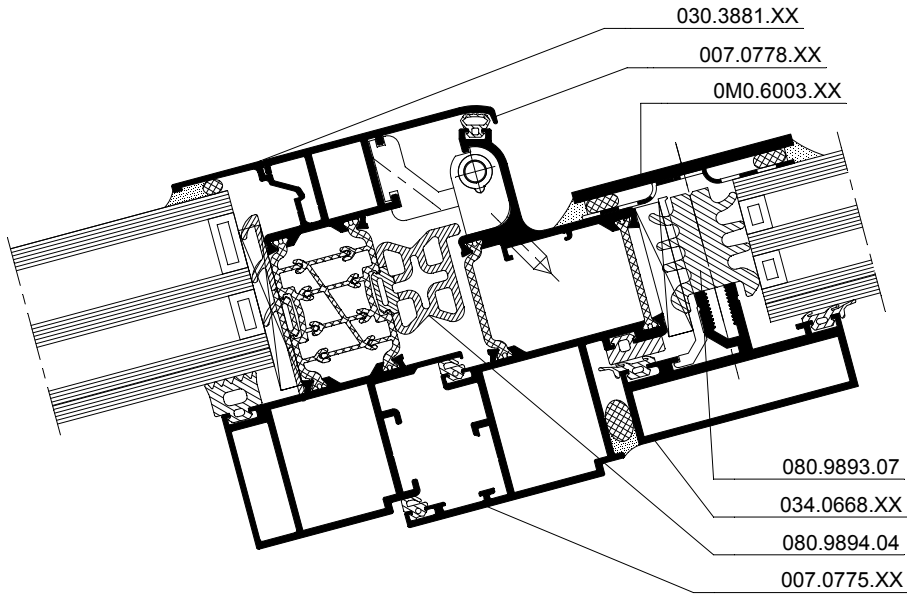

CR120-252004.dxf  
CR120-252004.dwg