

# CS 59Pa

CS 59Pa



**REYNAERS**  
aluminium



## CS 59Pa

---



### CS 59Pa (ramen)

- 1 Vaste elementen
- 2 Opende elementen
- 3 Samengestelde elementen
- 4 Koppelingen binnen het systeem

### CS 59Pa (deuren)

- 5 Naar binnen draaiend
- 6 Naar buiten draaiend

### CS 59Pa Front (CS 59Pa-Fr)

### CS 59Pa Automatic Sliding Door (CS 59Pa-AD)

### CS 59Pa Swing Door (CS 59Pa-SD)

### CS 59Pa Clampable Door (CS 59Pa-CD)

### Koppelingen met andere systemen

## CS 59Pa (Ramen)



### 1 Vaste elementen

#### Buitenkaders

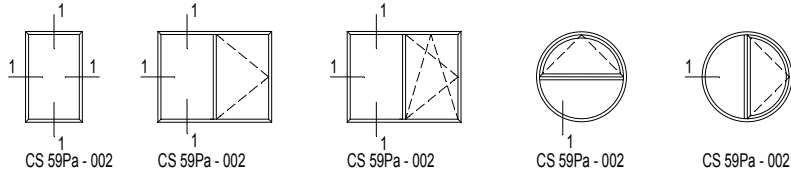

#### Rolluikgeleider

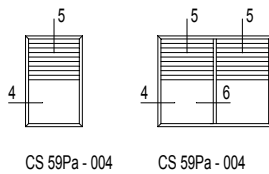

#### Leklijst

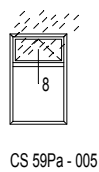

#### Verdeling in vast raam

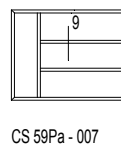

### 2 Opengaande elementen

#### Naar binnen opengaande ramen

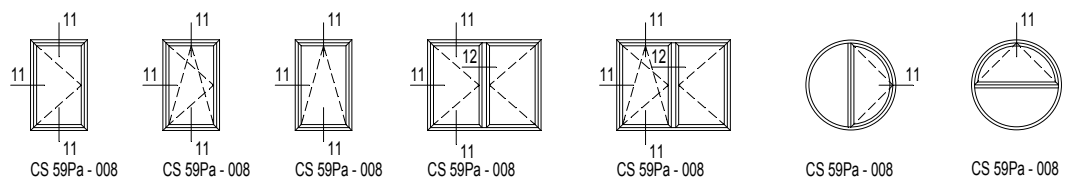

#### Verdeling in vleugel

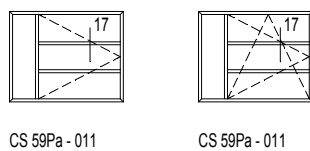

## CS 59Pa



### 3 Samengestelde elementen

T-Profiel

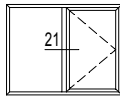

CS 59Pa - 012

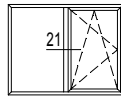

CS 59Pa - 012

T-Profiel versterkt

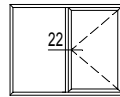

CS 59Pa - 015

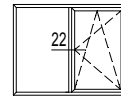

CS 59Pa - 015

Verstevigingsprofiel

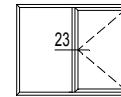

CS 59Pa - 016

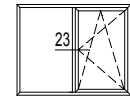

CS 59Pa - 016

Buitenkaders / T-profiel

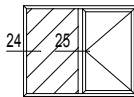

CS 59Pa - 020

Wisselprofiel buitenbeglazing

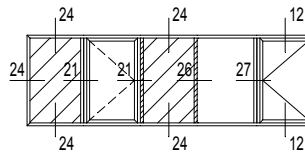

CS 59Pa - 023

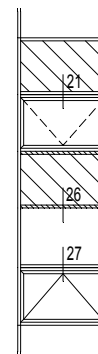

CS 59Pa - 023

### 4 Koppelingen binnen het systeem

In hetzelfde vlak

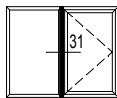

CS 59Pa - 024

Dilatatie

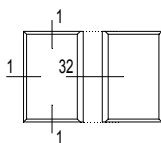

CS 59Pa - 025

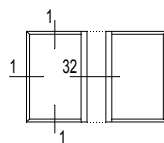

CS 59Pa - 025

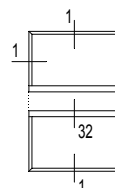

CS 59Pa - 025

Hoekprofielen

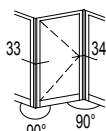

CS 59Pa - 026

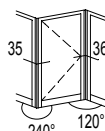

CS 59Pa - 028

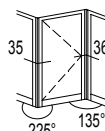

CS 59Pa - 028

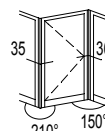

CS 59Pa - 028

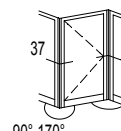

CS 59Pa - 029

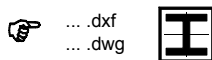
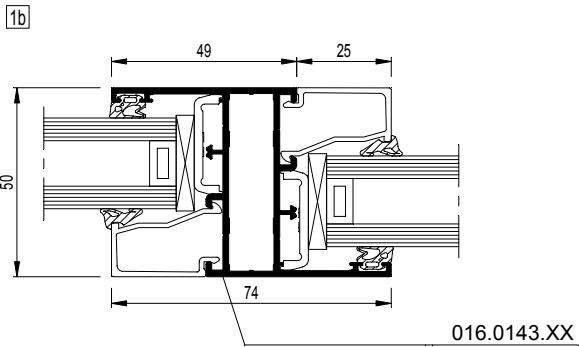
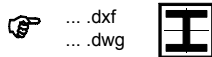
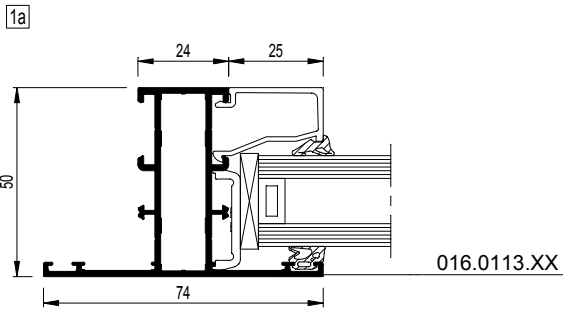
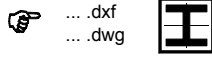
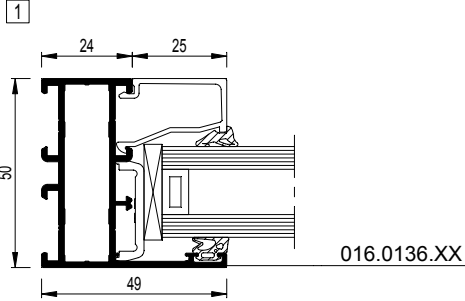
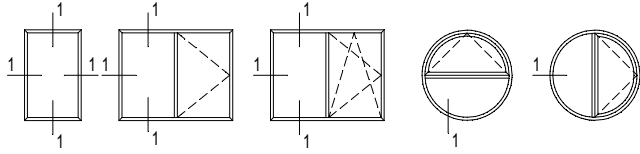

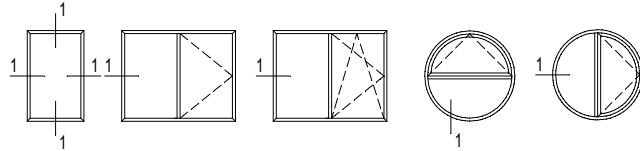

<p><b>016.0136.XX</b></p> <p><math>I_x = 10.135 \text{ cm}^4</math></p> <p>1 CS59Pa-001001.dxf CS59Pa-001001.dwg</p>	<p><b>016.0106.XX</b></p> <p><math>I_x = 9.933 \text{ cm}^4</math></p> <p>1 CS59Pa-001002.dxf CS59Pa-001002.dwg</p>	<p><b>016.0183.XX</b></p> <p><math>I_x = 12.836 \text{ cm}^4</math></p> <p>1 CS59Pa-001003.dxf CS59Pa-001003.dwg</p>	<p><b>016.0125.XX</b></p> <p><math>I_x = 15.047 \text{ cm}^4</math></p> <p>1 CS59Pa-001004.dxf CS59Pa-001004.dwg</p>
<p><b>016.0143.XX</b></p> <p><math>I_x = 13.090 \text{ cm}^4</math></p> <p>1 CS59Pa-001005.dxf CS59Pa-001005.dwg</p>			
<p><b>016.0113.XX</b></p> <p><math>I_x = 11.786 \text{ cm}^4</math></p> <p>1a CS59Pa-001006.dxf CS59Pa-001006.dwg</p>	<p><b>016.0120.XX</b></p> <p><math>I_x = 14.610 \text{ cm}^4</math></p> <p>1a CS59Pa-001007.dxf CS59Pa-001007.dwg</p>	<p><b>016.0114.XX</b></p> <p><math>I_x = 16.886 \text{ cm}^4</math></p> <p>1a CS59Pa-001008.dxf CS59Pa-001008.dwg</p>	
<p><b>016.0143.XX</b></p> <p><math>I_x = 13.090 \text{ cm}^4</math></p> <p>1b CS59Pa-001009.dxf CS59Pa-001009.dwg</p>	<p><b>016.0105.XX</b></p> <p><math>I_x = 7.021 \text{ cm}^4</math></p> <p>1b CS59Pa-001010.dxf CS59Pa-001010.dwg</p>		

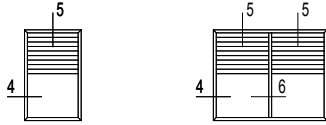

4

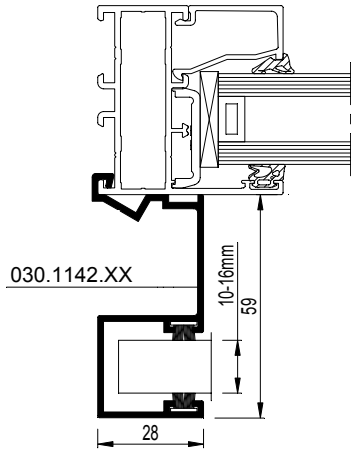

CS59Pa-004001.dxf  
 CS59Pa-004001.dwg

5

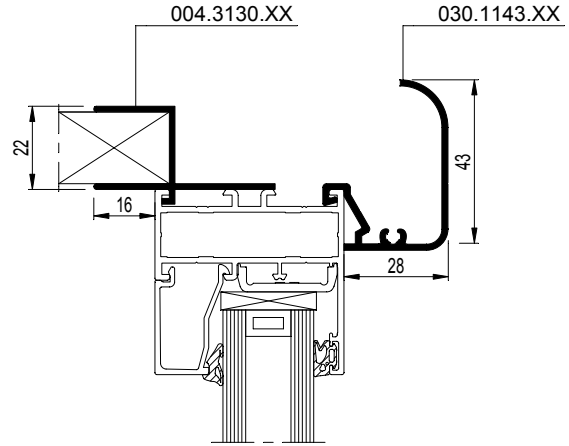

CS59Pa-005001.dxf  
 CS59Pa-005001.dwg

5

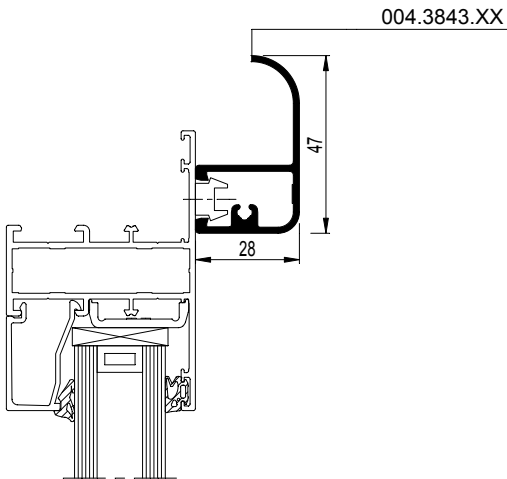

CS59Pa-005002.dxf  
 CS59Pa-005002.dwg



# CS 59Pa

Vaste elementen - Leklijst  
Eléments fixes - Rejet d'eau  
Fixed elements - Drip cap  
Feste Elemente - Wetterschenkel

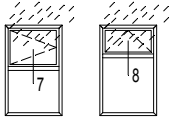

7

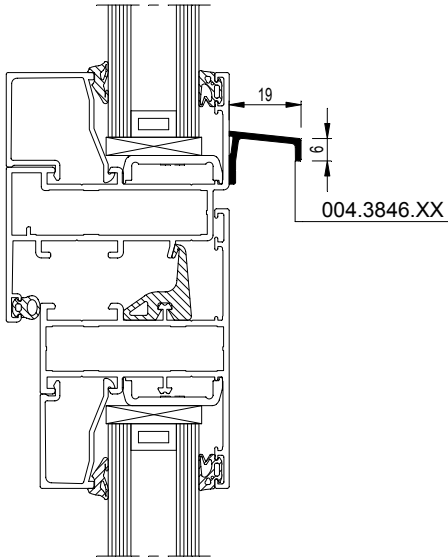

CS59Pa-007001.dxf  
CS59Pa-007001.dwg

8

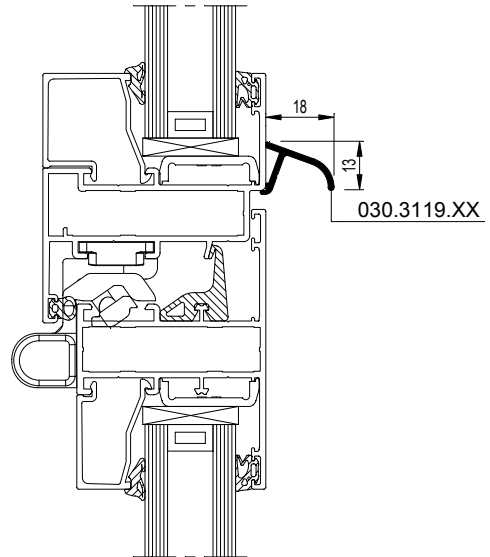

CS59Pa-008001.dxf  
CS59Pa-008001.dwg

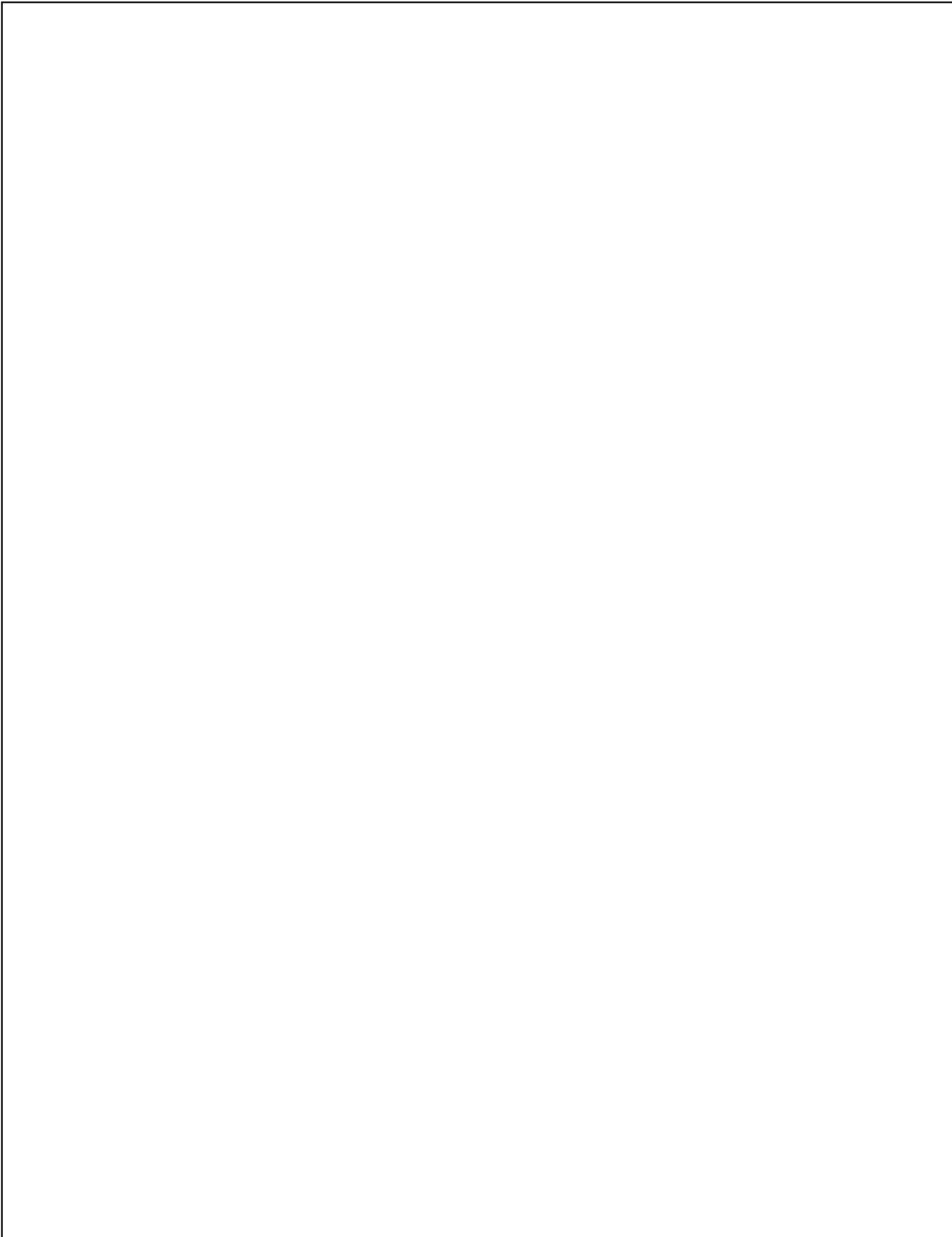

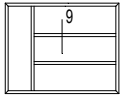

9

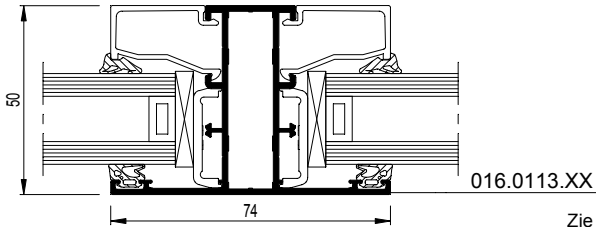

Zie ook T-profielen op blz. 12-13  
Voir aussi traverses page 12-13  
See also transom-mullions on pages 12-13  
Siehe auch Sprossen Seite 12-13

CS59Pa-009003.dxf  
CS59Pa-009003.dwg

9

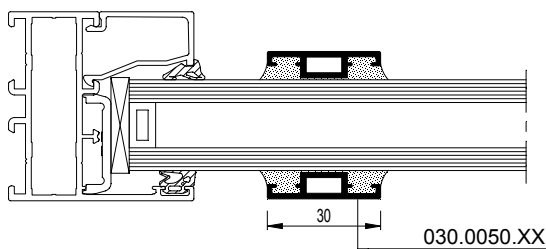

CS59Pa-009002.dxf  
CS59Pa-009002.dwg

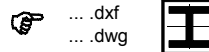
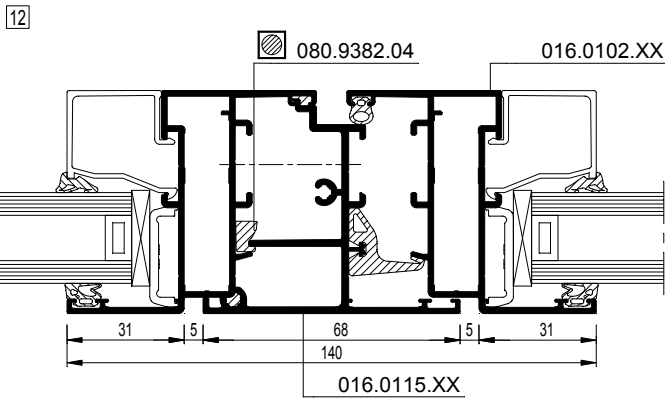
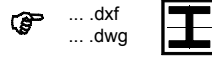
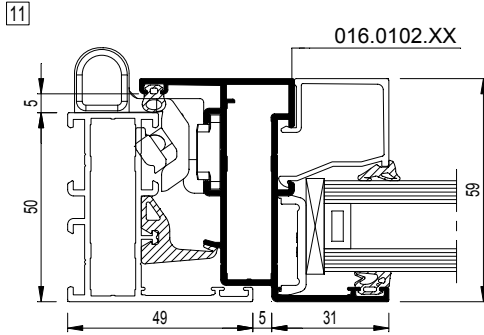
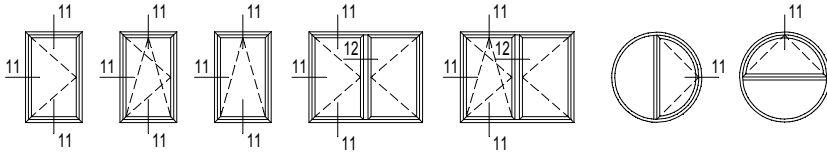

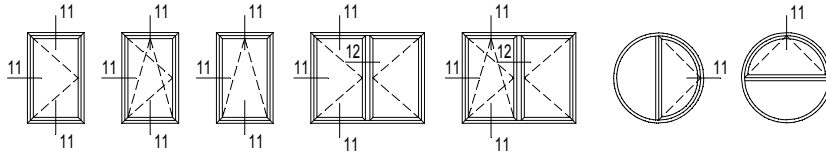

## 016.0102.XX

$I_x = 16.445 \text{ cm}^4$

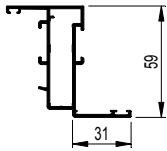

11

CS59Pa-011001.dxf  
 CS59Pa-011001.dwg

12

CS59Pa-012001.dxf  
 CS59Pa-012001.dwg

## 016.0192.XX

$I_x = 20.858 \text{ cm}^4$

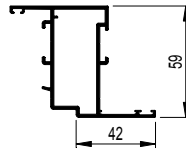

11

CS59Pa-011002.dxf  
 CS59Pa-011002.dwg

12

CS59Pa-012002.dxf  
 CS59Pa-012002.dwg

## 016.0121.XX

$I_x = 27.002 \text{ cm}^4$

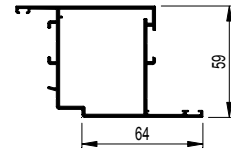

11

CS59Pa-011003.dxf  
 CS59Pa-011003.dwg

12

CS59Pa-012003.dxf  
 CS59Pa-012003.dwg

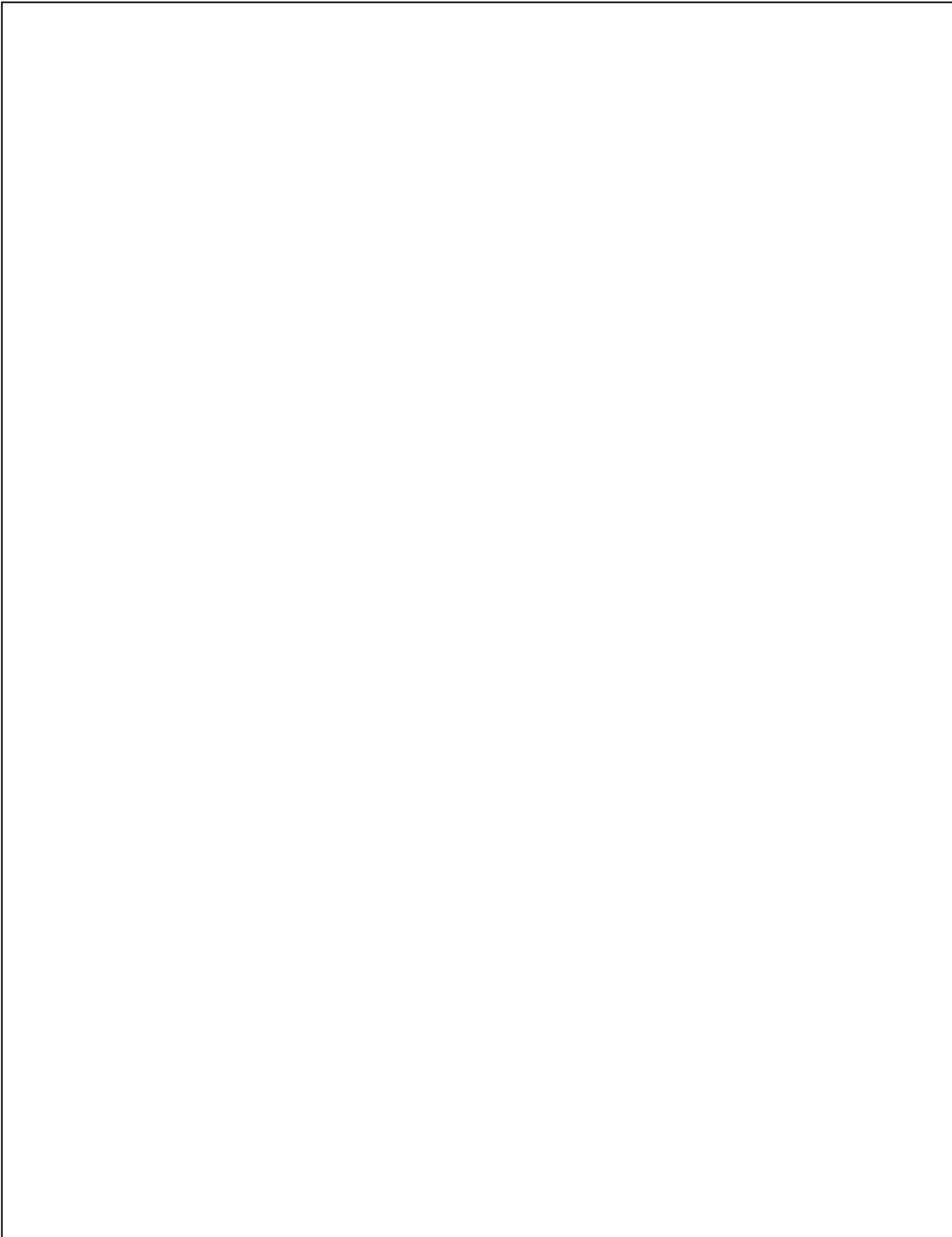

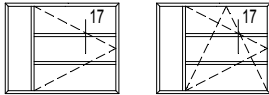

17

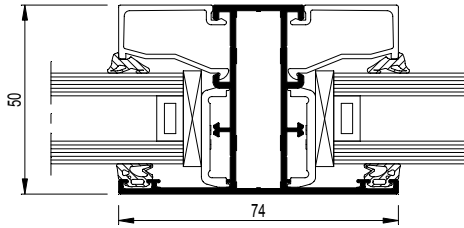

☞ Zie ook T-profielen op blz. 12-13  
Voir aussi traverses page 12-13  
See also transom-mullions on pages 12-13  
Siehe auch Sprossen Seite 12-13

CS59Pa-017001.dxf  
CS59Pa-017001.dwg

17

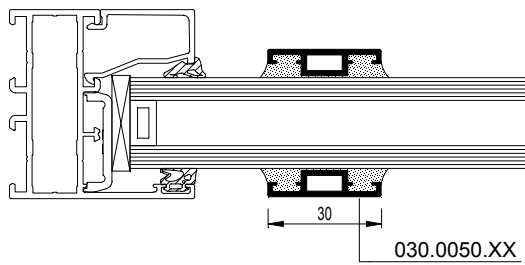

CS59Pa-017002.dxf  
CS59Pa-017002.dwg

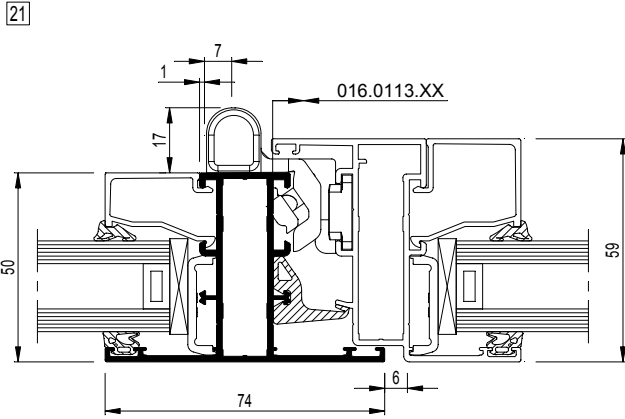
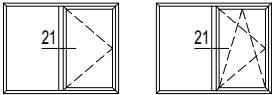

... .dxf  
 ... .dwg



## 016.0113.XX

$I_x = 11.786 \text{ cm}^4$

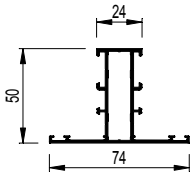

21 CS59Pa-021001.dxf  
 CS59Pa-021001.dwg

## 016.0120.XX

$I_x = 14.610 \text{ cm}^4$

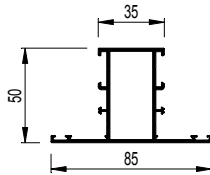

21 CS59Pa-021002.dxf  
 CS59Pa-021002.dwg

## 016.0114.XX

$I_x = 16.886 \text{ cm}^4$

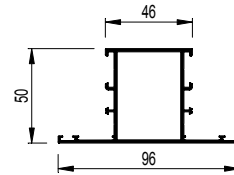

21 CS59Pa-021003.dxf  
 CS59Pa-021003.dwg

## 016.0813.XX

$I_x = 13.054 \text{ cm}^4$

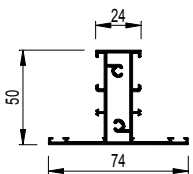

21 CS59Pa-021004.dxf  
 CS59Pa-021004.dwg

## 016.0820.XX

$I_x = 15.700 \text{ cm}^4$

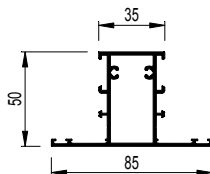

21 CS59Pa-021005.dxf  
 CS59Pa-021005.dwg

## 016.0814.XX

$I_x = 17.934 \text{ cm}^4$

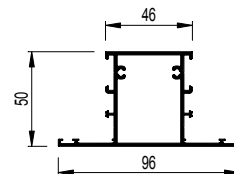

21 CS59Pa-021006.dxf  
 CS59Pa-021006.dwg



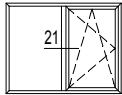
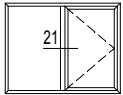

016.0817.XX

$I_x = 33.870 \text{ cm}^4$

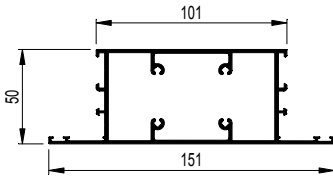

CS59Pa-021007.dxf  
CS59Pa-021007.dwg

016.0847.XX

$I_x = 36.435 \text{ cm}^4$

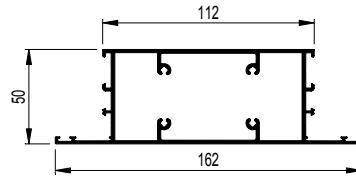

CS59Pa-021008.dxf  
CS59Pa-021008.dwg

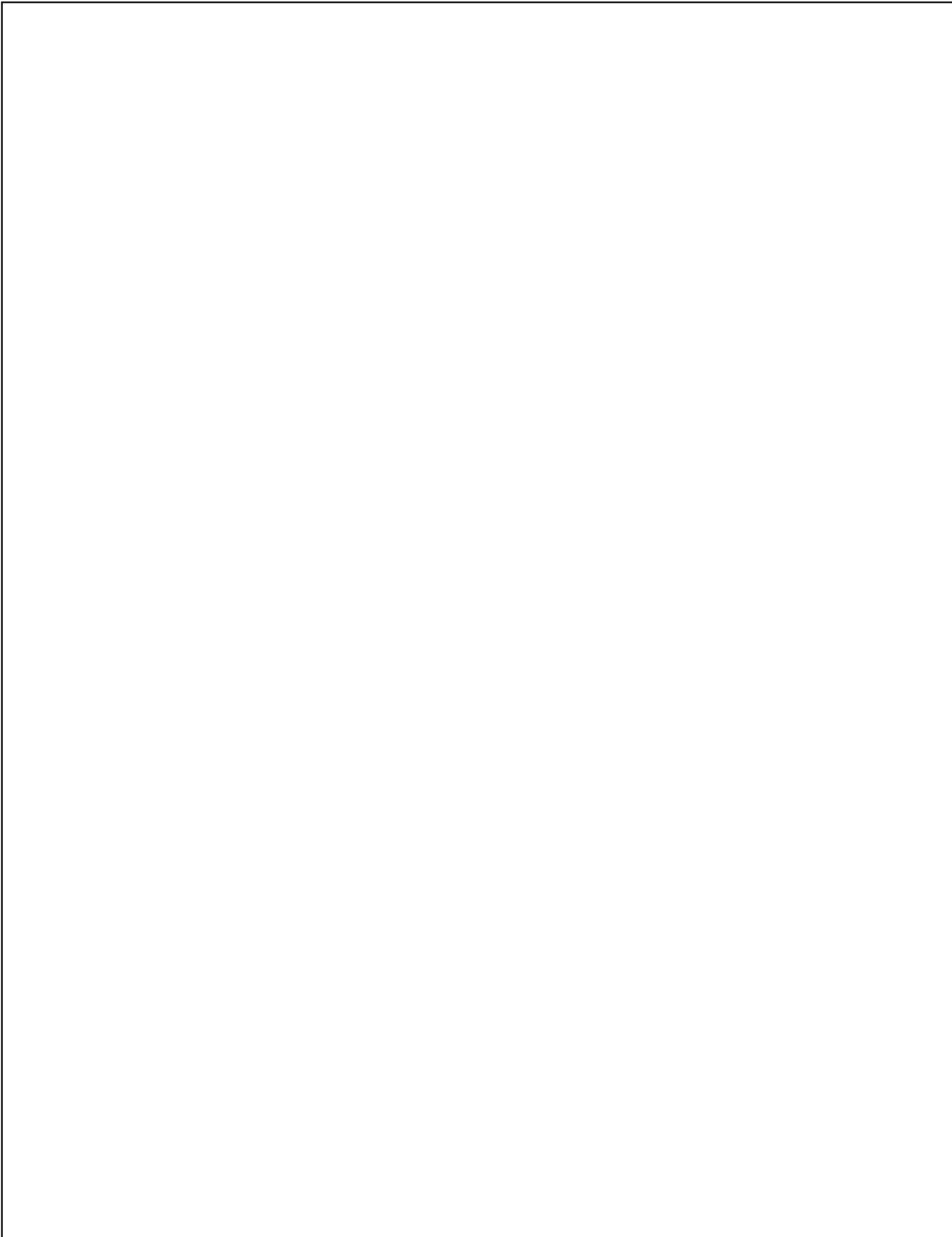

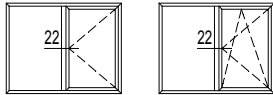

22

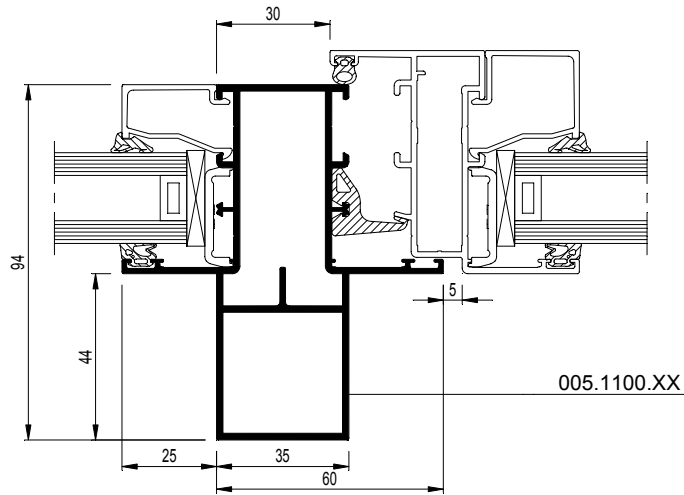

CS59Pa-022001.dxf  
 CS59Pa-022001.dwg

Eindstukken beschikbaar  
 Pièces finales disponibles  
 End caps available  
 Endstücke verfügbar

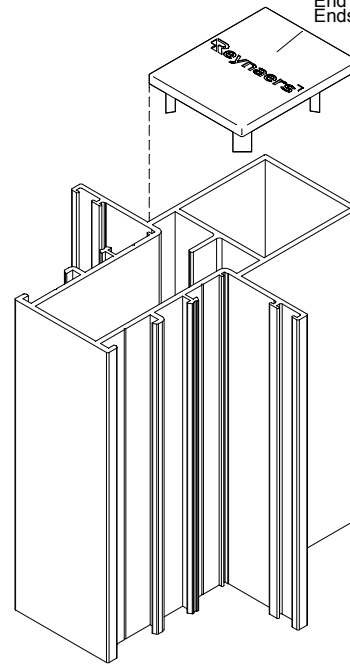

CS59Pa-3d0002.dxf  
 CS59Pa-3d0002.dwg

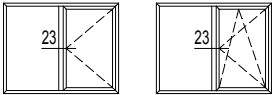

23a

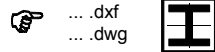
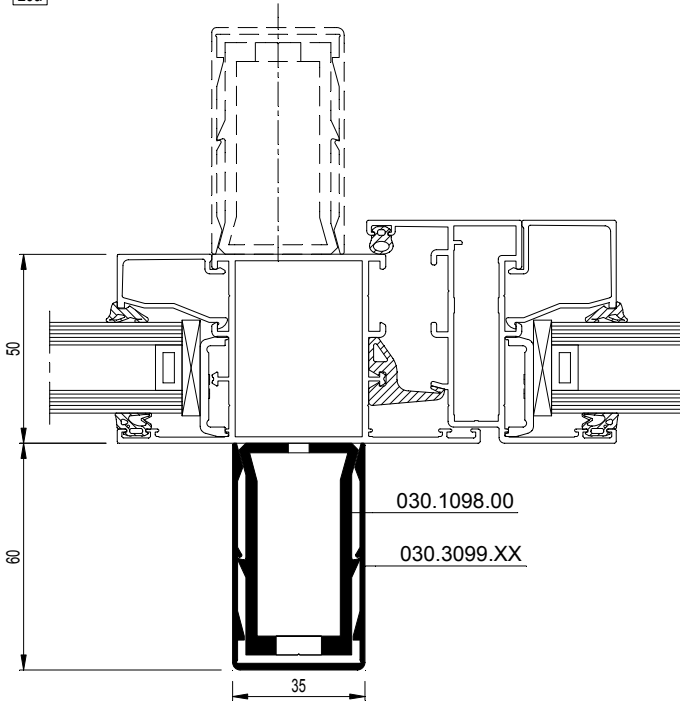

23

Nota : voor keuze van versteviging : zie waarden op blz 18-19  
 Note : pour choix de renforcement : voir valeurs page 18-19  
 Note : For choice of reinforcement, see values on pages 18-19  
 Note : für Verstärkungswahl : siehe Werte Seite 18-19

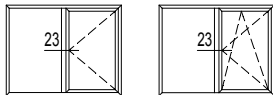

030.1098.00

$I_x = 19.656 \text{ cm}^4$



23

CS59Pa-023003.dxf  
 CS59Pa-023003.dwg

030.3099.XX

$I_x = 9.625 \text{ cm}^4$

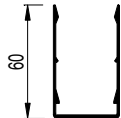

030.1097.00

$I_x = 10.260 \text{ cm}^4$



23

CS59Pa-023004.dxf  
 CS59Pa-023004.dwg

030.3099.XX

$I_x = 9.625 \text{ cm}^4$

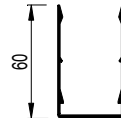

030.1096.00

$I_x = 4.881 \text{ cm}^4$



23

CS59Pa-023005.dxf  
 CS59Pa-023005.dwg

030.3097.XX

$I_x = 2.767 \text{ cm}^4$





Opmerking: - Versteviging van binnenzijde + scharnier is niet mogelijk indien de binnenzijde van een T-profiel < 75 mm breedte is.  
- Bevestiging: om de 300 mm  
- Bij horizontale versteviging, contacteer Reynaers Consult



Remarque: - Positionnement du renfort à l'intérieur en présence de charnières non possible sur profilé-T de largeur intérieure < 75 mm  
- Fixation: tous les 300 mm  
- Pour utilisation comme renfort horizontal, contactez Reynaers Consult

Remark: - Reinforcement of inner side + hinge is not possible in case the inner side of a transom-mullion < 75 mm  
- For horizontal reinforcements, please contact Reynaers Consult - tel. 015/30 88 99

Anmerkung: - Verstärkung der Innenseite und Band ist unmöglich wenn die Innenseite einer Sprosse < 75 mm  
- Bevestigung: jede 300 mm  
- Bei horizontaler Verstärkung, bitte nehmen Sie Kontakt auf mit Reynaers Consult

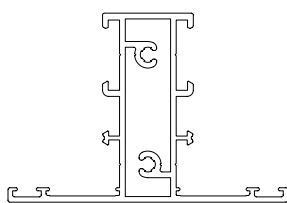
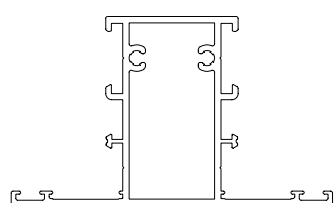
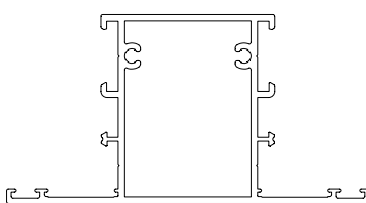
 T-profiel Sprosse Transom-mullion Traverse	Zonder versteviging Sans renforcement Without reinforcement Ohne Verstärkung			met avec with mit 030.1097.XX		met avec with mit 030.1098.XX	
	Ix cm4	Wx cm3	e	Ix cm4	Wx cm3	Ix cm4	Wx cm3
016.0813.XX  	13.054	4.298	e  i	53.32	10.09	81.00	13.88
016.0820.XX  	15.700	5.437	e  i	59.26	10.83	89.20	15.77
016.0814.XX  	17.934	6.276	e  i	62.97	11.29	94.39	17.05

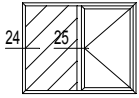

24

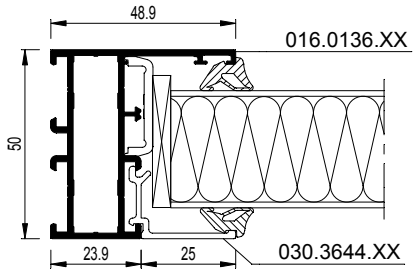

 ... .dxf  
... .dwg



25

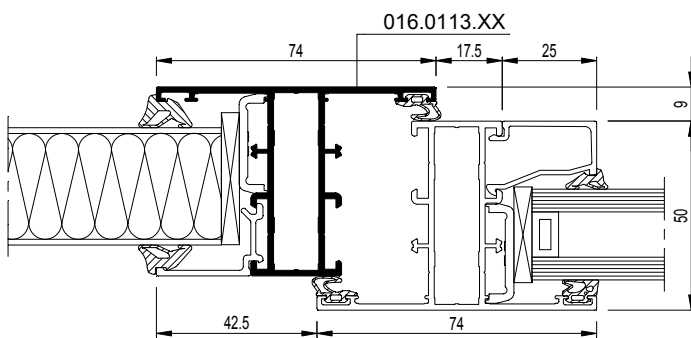

 ... .dxf  
... .dwg





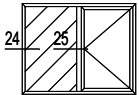

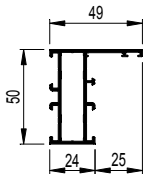

## 016.0136.XX

$I_x = 10.135 \text{ cm}^4$



 CS59Pa-024001.dxf  
 CS59Pa-024001.dwg

## 016.0183.XX

$I_x = 12.836 \text{ cm}^4$

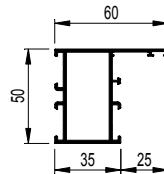

 CS59Pa-024002.dxf  
 CS59Pa-024002.dwg

## 016.0125.XX

$I_x = 15.047 \text{ cm}^4$

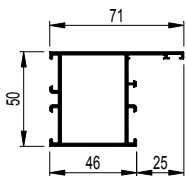

 CS59Pa-024003.dxf  
 CS59Pa-024003.dwg

## 016.0113.XX

$I_x = 11.786 \text{ cm}^4$

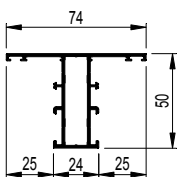

 CS59Pa-025001.dxf  
 CS59Pa-025001.dwg

## 016.0120.XX

$I_x = 14.610 \text{ cm}^4$

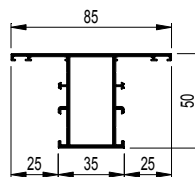

 CS59Pa-025002.dxf  
 CS59Pa-025002.dwg

## 016.0114.XX

$I_x = 16.886 \text{ cm}^4$

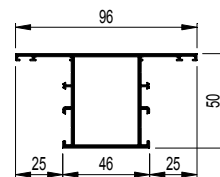

 CS59Pa-025003.dxf  
 CS59Pa-025003.dwg

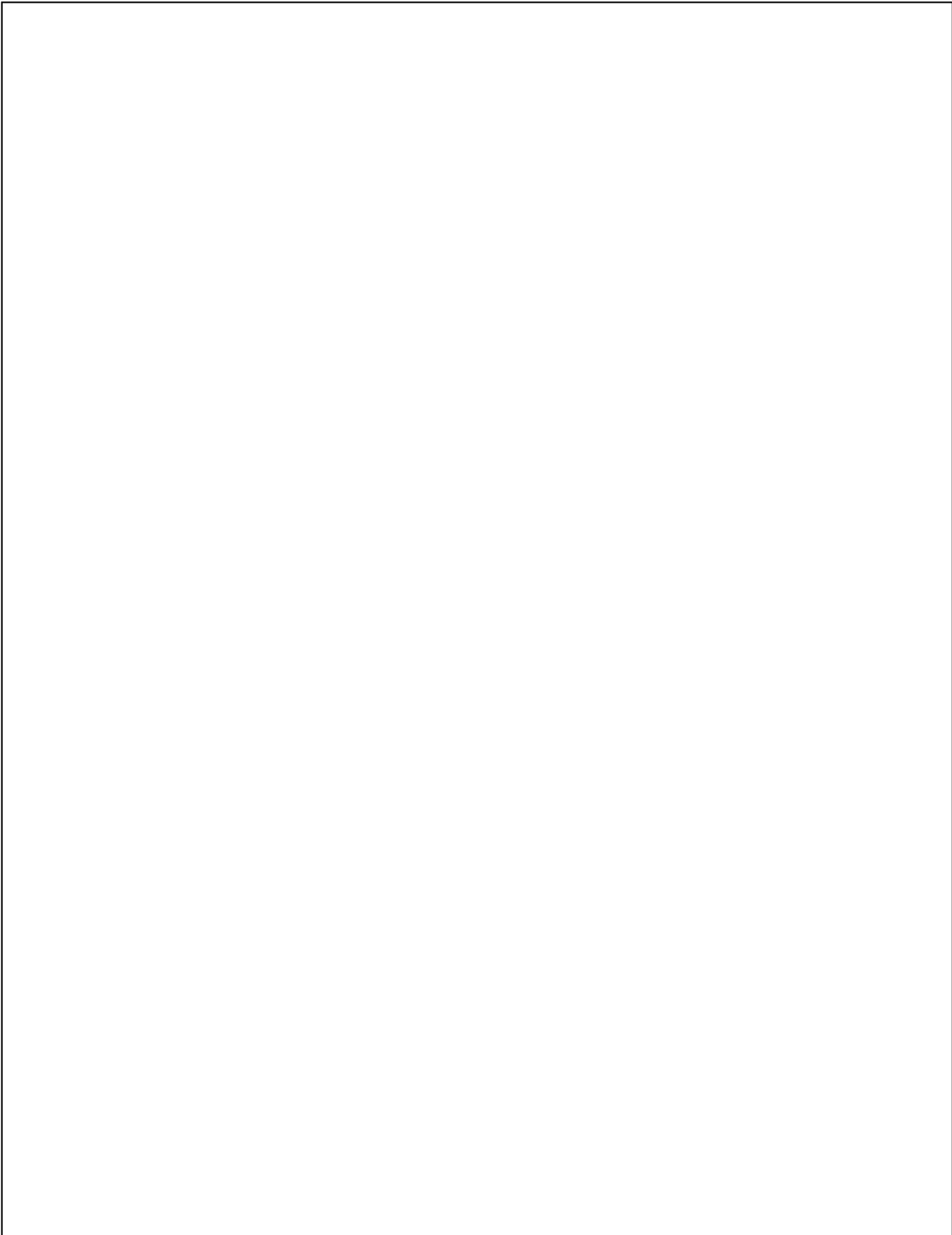

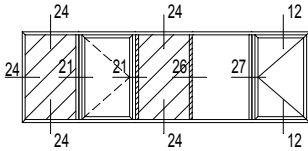

26

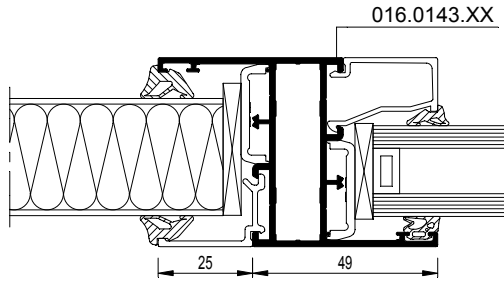

... .dxf  
 ... .dwg

27

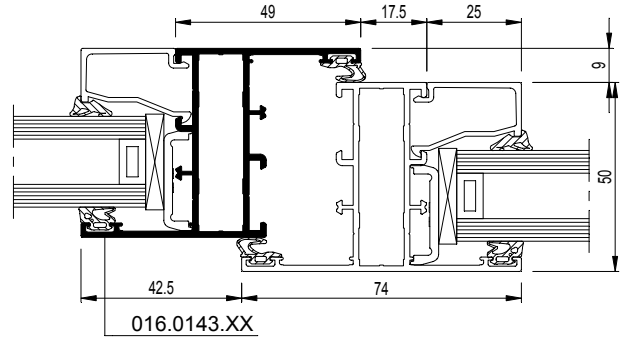

... .dxf  
 ... .dwg

016.0143.XX

$I_x = 13.090 \text{ cm}^4$

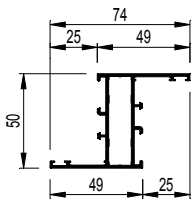

- 26 CS59Pa-026001.dxf  
 CS59Pa-026001.dwg
- 27 CS59Pa-027001.dxf  
 CS59Pa-027001.dwg

016.0105.XX

$I_x = 7.021 \text{ cm}^4$

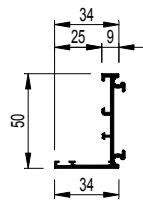

- 26 CS59Pa-026002.dxf  
 CS59Pa-026002.dwg
- 27 CS59Pa-027002.dxf  
 CS59Pa-027002.dwg

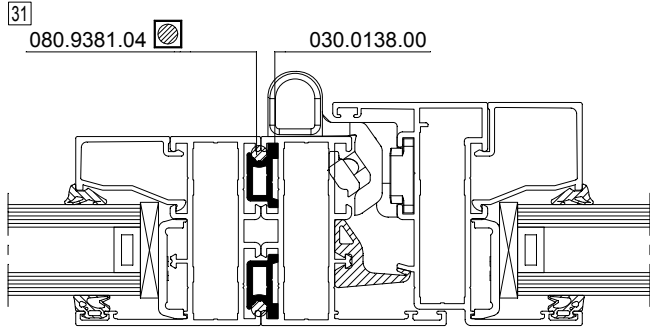
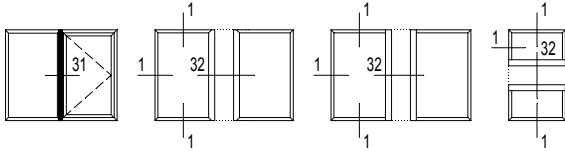

CS59Pa-031001.dxf  
 CS59Pa-031001.dwg

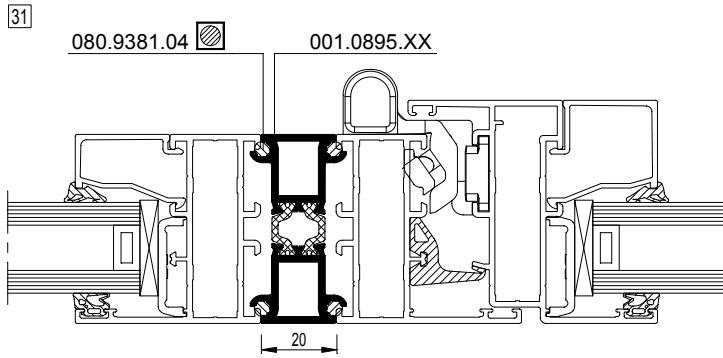

## 001.0895.XX

$I_x = 7.010 \text{ cm}^4$

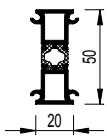

CS59Pa-031002.dxf  
 CS59Pa-031002.dwg

## 005.1848.XX

$I_x = 90.907 \text{ cm}^4$

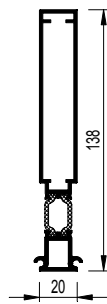

CS59Pa-031004.dxf  
 CS59Pa-031004.dwg

## 006.0371.XX

$I_x = 120.097 \text{ cm}^4$

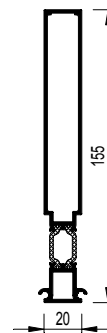

CS59Pa-031005.dxf  
 CS59Pa-031005.dwg

## 005.1837.XX

$I_x = 58.021 \text{ cm}^4$

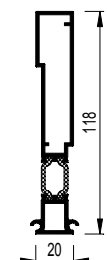

CS59Pa-031003.dxf  
 CS59Pa-031003.dwg

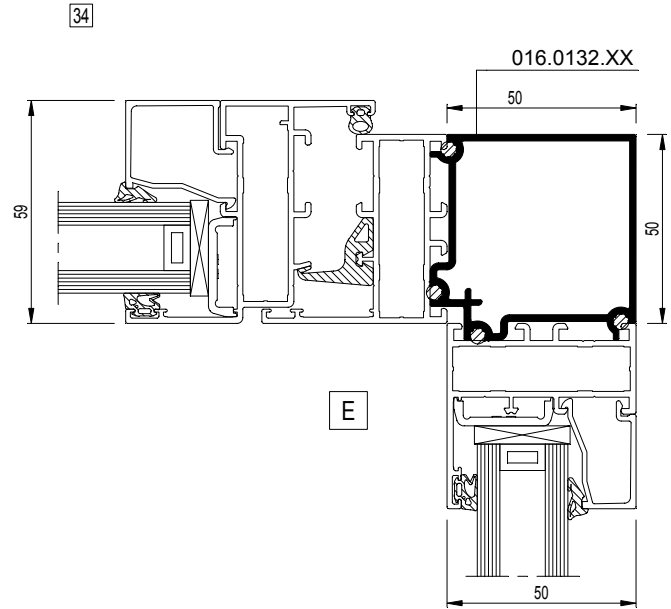
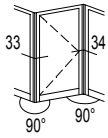

CS59Pa-034001.dxf  
 CS59Pa-034001.dwg

33

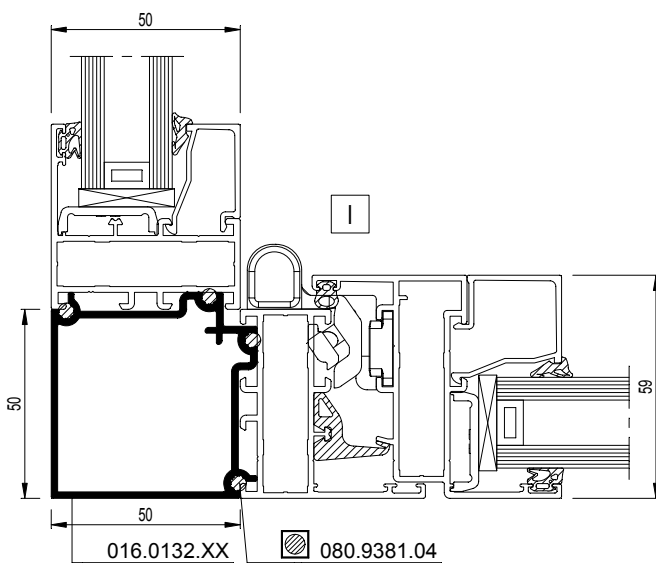

CS59Pa-033001.dxf  
 CS59Pa-033001.dwg

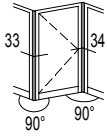

33

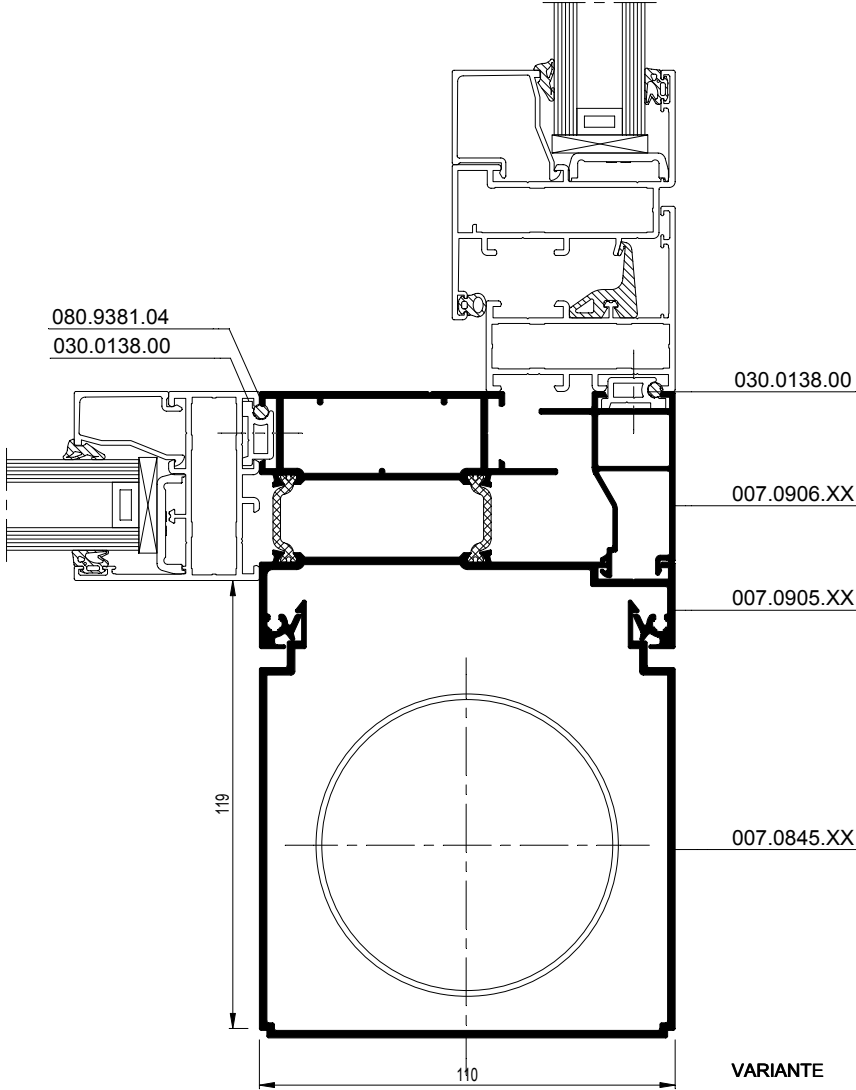

CS59Pa-033002.dxf  
CS59Pa-033002.dwg

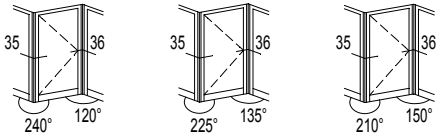

36

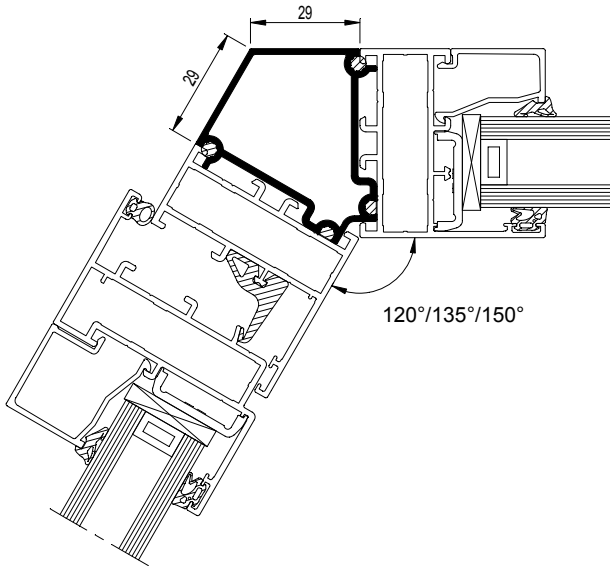

35

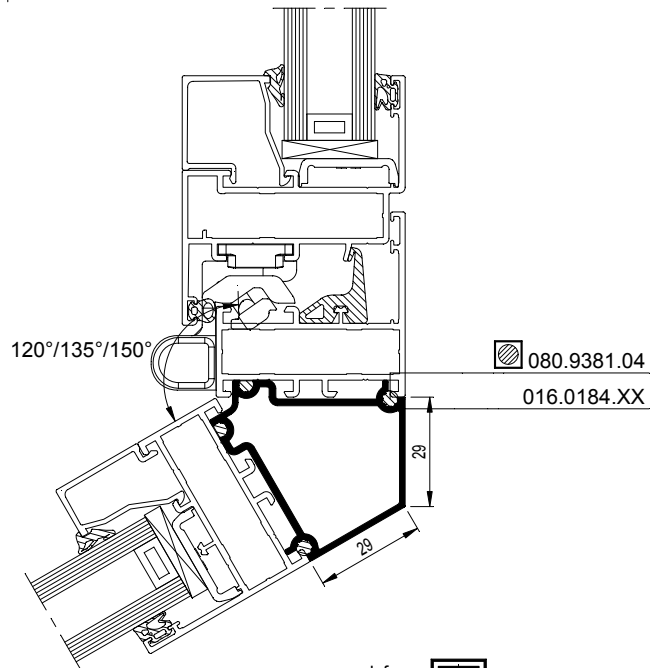

☞ ... .dxf  
 ... .dwg

☞ ... .dxf  
 ... .dwg

016.0184.XX

$I_x = 7.785 \text{ cm}^4$

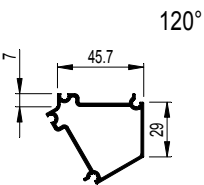

35 CS59Pa-035001.dxf  
 CS59Pa-035001.dwg

36 CS59Pa-036001.dxf  
 CS59Pa-036001.dwg

016.0178.XX

$I_x = 6.505 \text{ cm}^4$

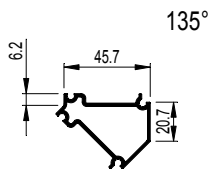

35 CS59Pa-035002.dxf  
 CS59Pa-035002.dwg

36 CS59Pa-036002.dxf  
 CS59Pa-036002.dwg

016.0179.XX

$I_x = 2.119 \text{ cm}^4$

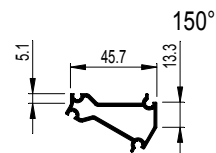

35 CS59Pa-035003.dxf  
 CS59Pa-035003.dwg

36 CS59Pa-036003.dxf  
 CS59Pa-036003.dwg

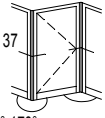

90°-170°

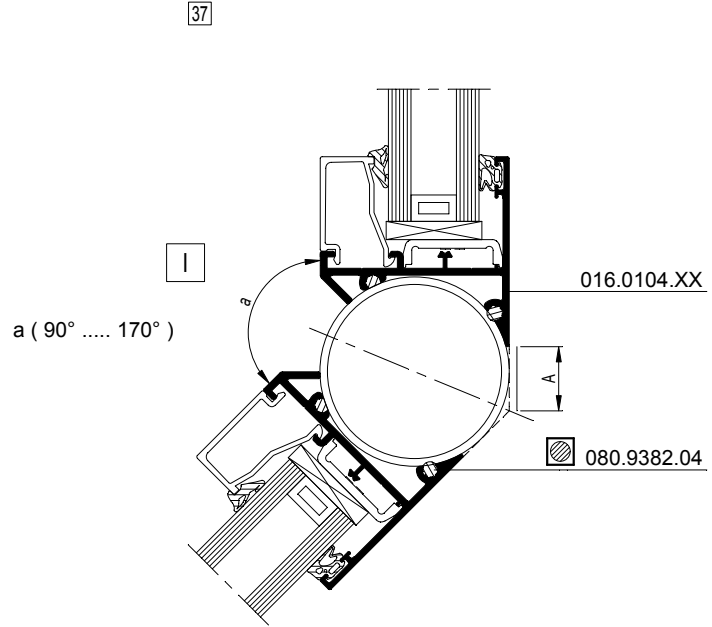

CS59Pa-037001.dxf  
 CS59Pa-037001.dwg

a	A
170°	8.8
160°	11
150°	13.3
140°	15.8
130°	18.3
120°	21.1
110°	24.2
100°	27.7
90°	31.7



## CS 59Pa (Deuren)



### 5 Deuren naar binnen draaiend

Naar binnen opengaande deuren

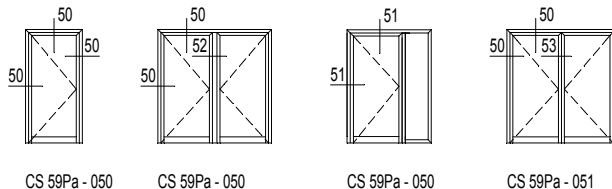

... met raamprofielen

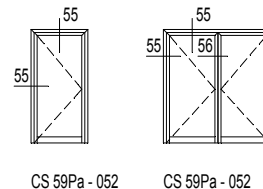

Naar binnen draaiende deuren met deurvleugel rondom geperst

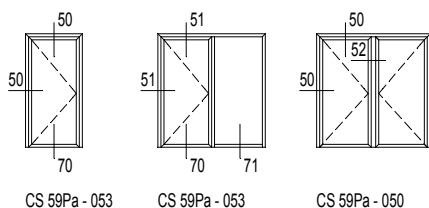

... met raamprofielen

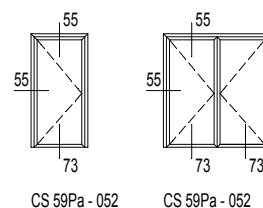

Deuren met T-profiel

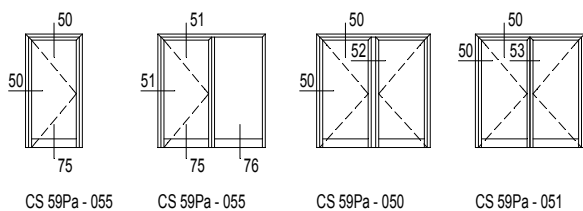

### 6 Deuren naar buiten draaiend

Naar buiten opengaande deuren

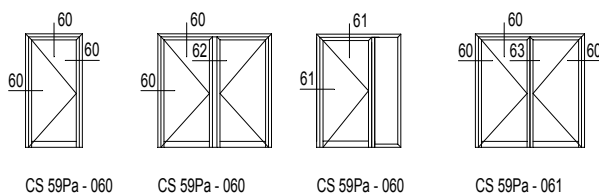

Naar buiten draaiende deuren met deurvleugel rondom geperst

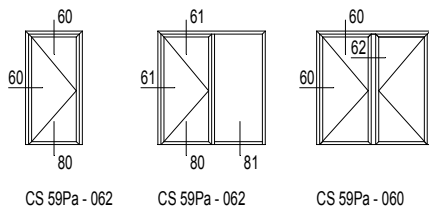

Deuren met T-profiel

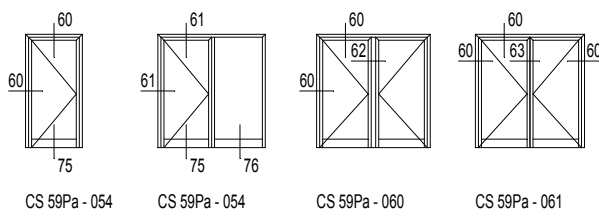

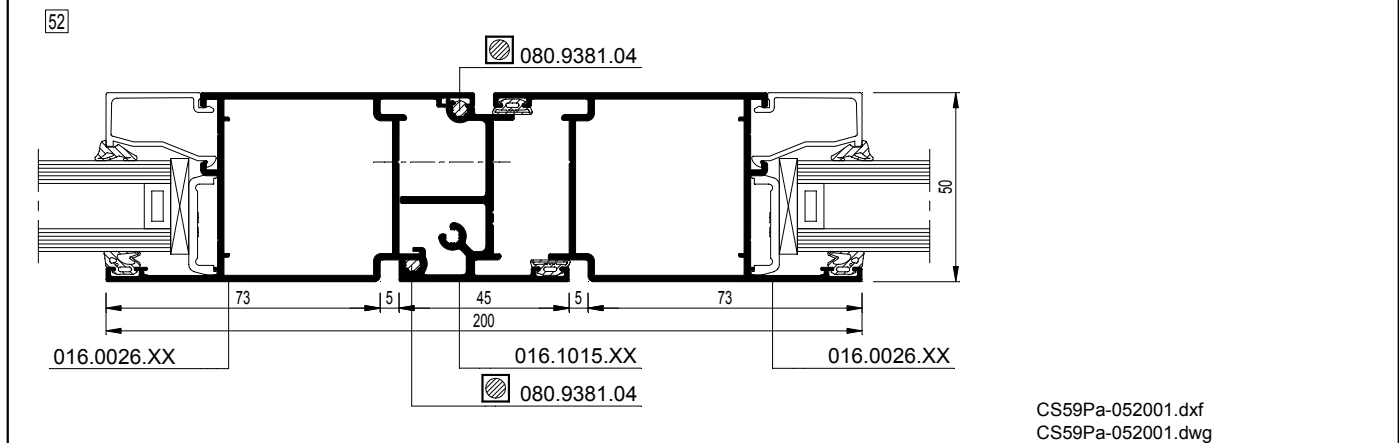
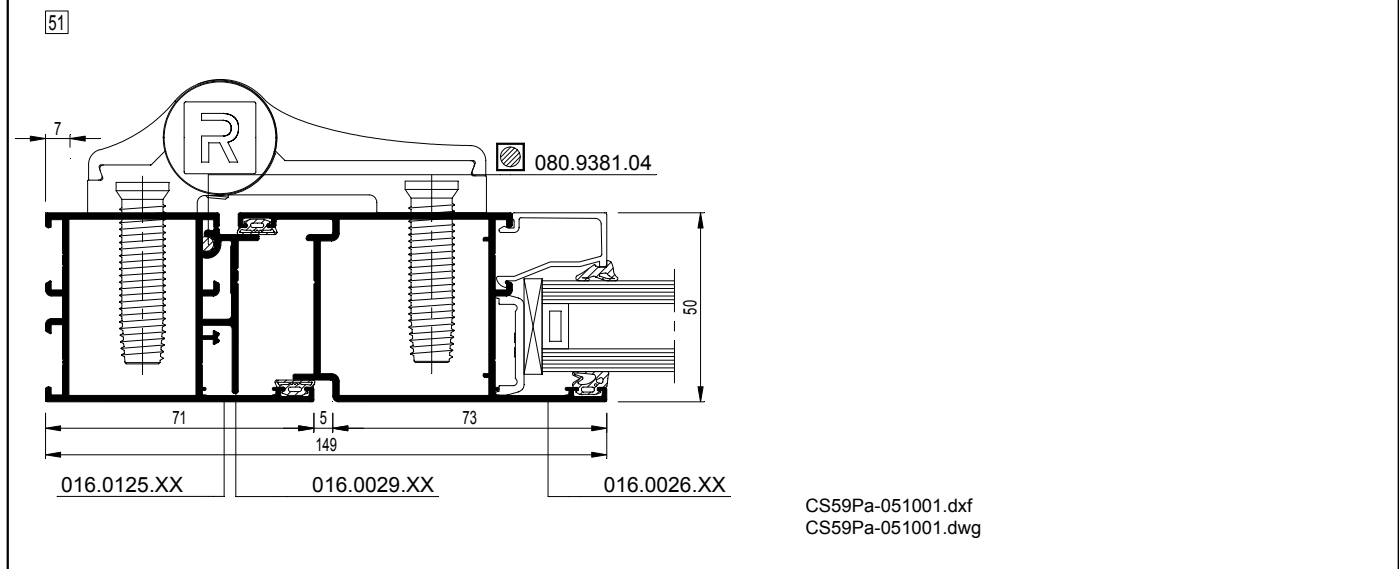
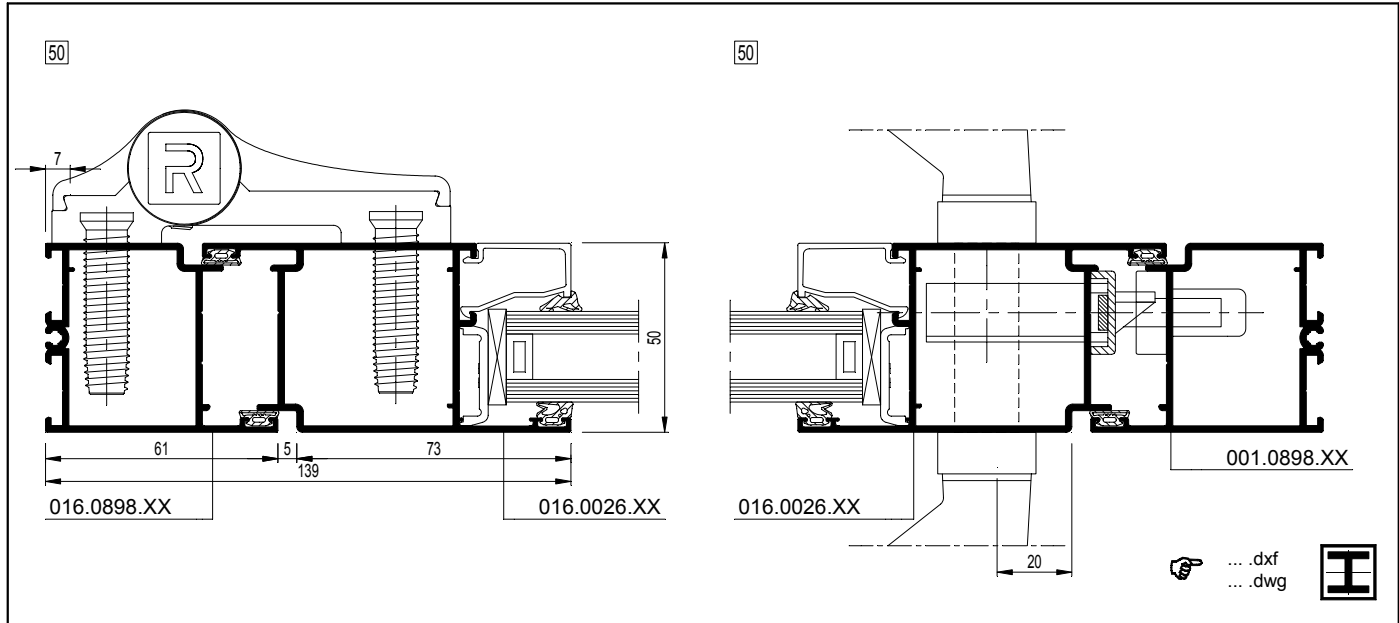
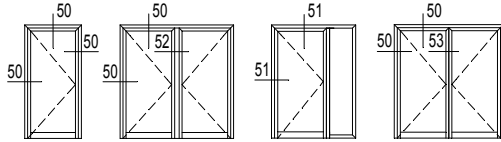

# CS 59Pa

Deuren naar binnen draaiend - Naar binnen opengaande deuren  
 Portes ouvrant vers l'intérieur - Portes ouvrant vers l'intérieur  
 Doors inward opening - Inward opening doors  
 Türen nach innen öffnend - Nach innen öffnende Türen

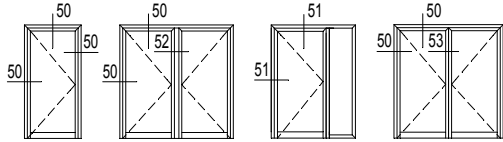

016.0898.XX

$I_x = 13.668 \text{ cm}^4$

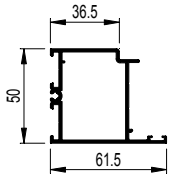

50 CS59Pa-050001.dxf  
 CS59Pa-050001.dwg

016.0014.XX

$I_x = 17.961 \text{ cm}^4$

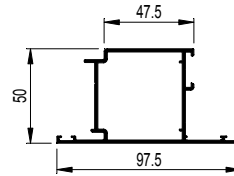

50 CS59Pa-050002.dxf  
 CS59Pa-050002.dwg

53 ZT

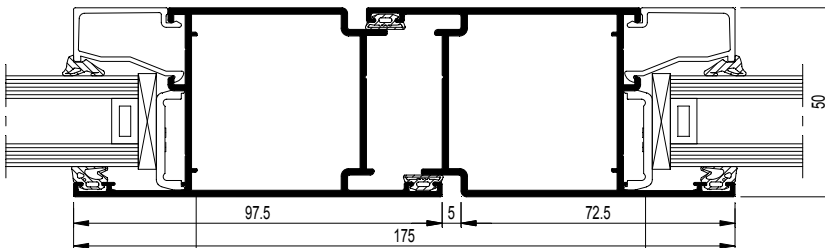

016.0014.XX

016.0026.XX

CS59Pa-053001.dxf  
 CS59Pa-053001.dwg

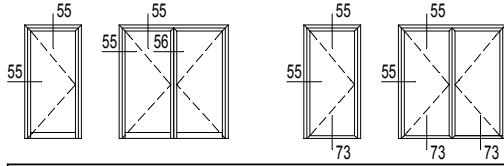

55

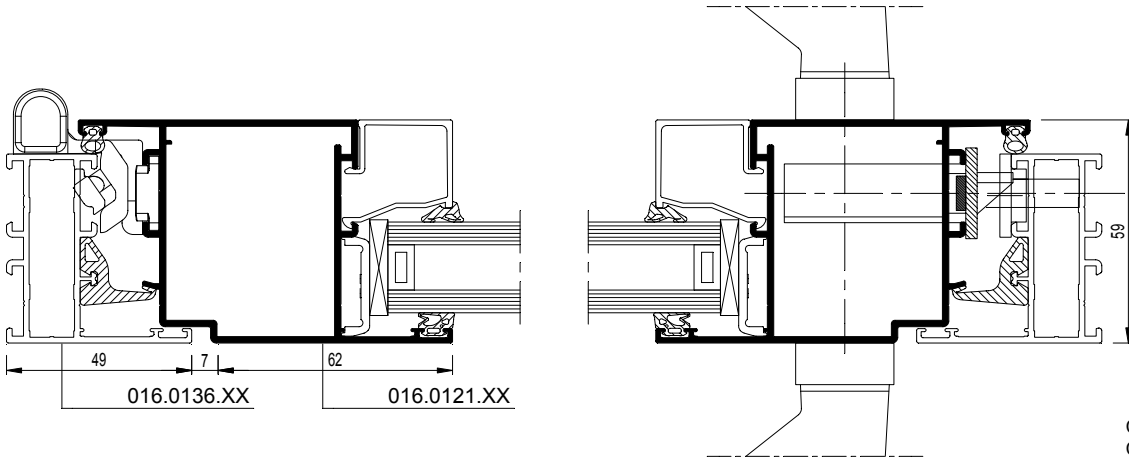

CS59Pa-055001.dxf  
 CS59Pa-055001.dwg

56

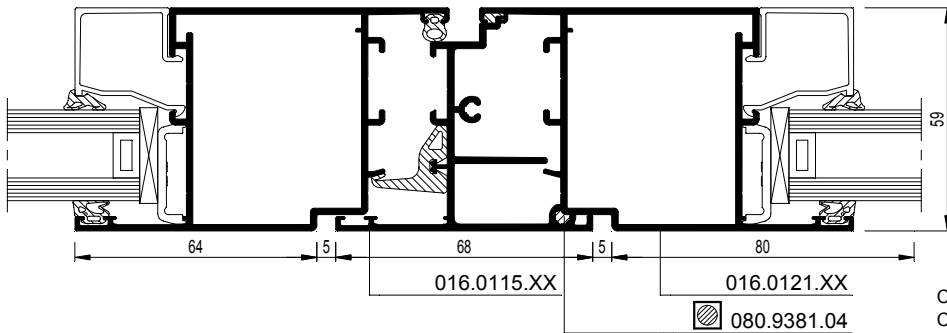

CS59Pa-056001.dxf  
 CS59Pa-056001.dwg

73

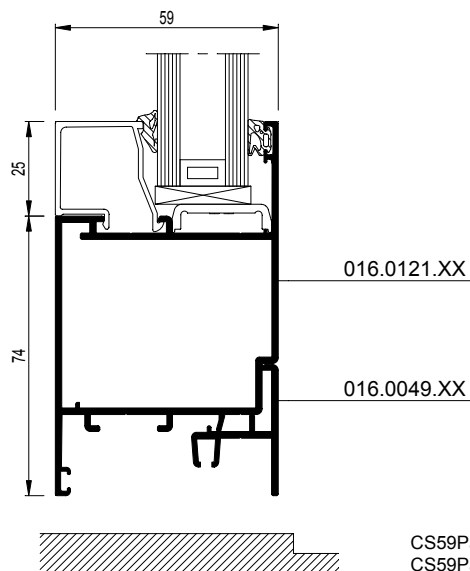

CS59Pa-073001.dxf  
 CS59Pa-073001.dwg

# CS 59Pa

Deuren - Naar binnen draaiende deuren met deurvleugel rondom geperst  
 Portes - Portes ouvrant vers l'intérieur avec ouvrant serti tout autour  
 Doors - Inward opening doors with vent crimped all round  
 Türen - Nach innen öffnende Türen mit rundherum gepresstem Türflügel

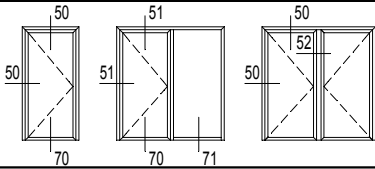

70

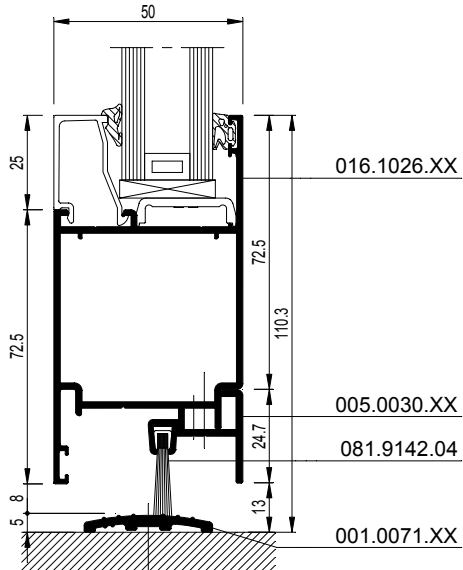

CS59Pa-070001.dxf  
 CS59Pa-070001.dwg

71

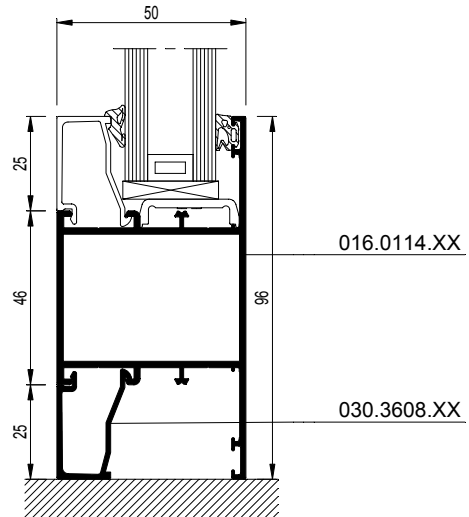

CS59Pa-071001.dxf  
 CS59Pa-071001.dwg

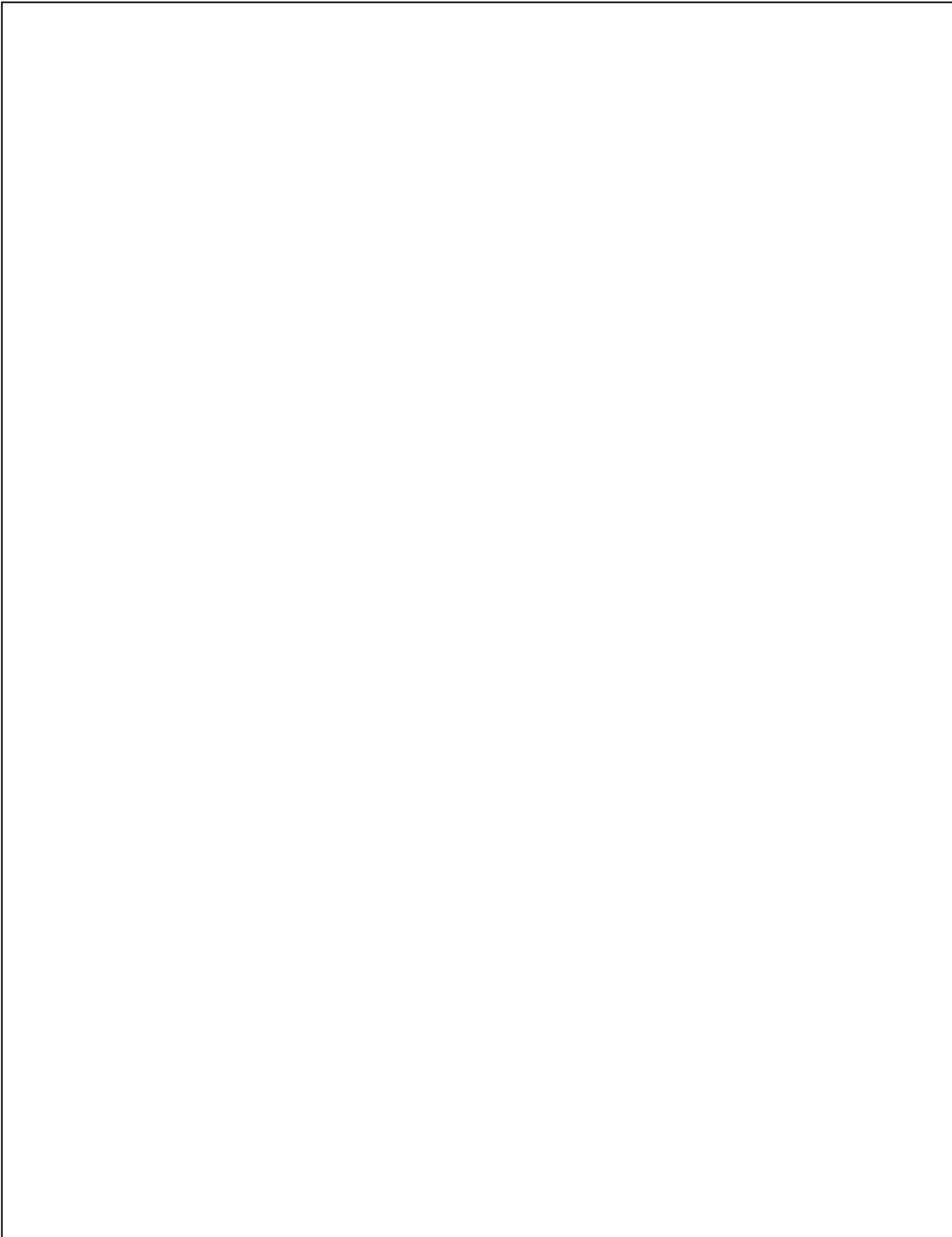

# CS 59Pa

Deuren naar binnen draaiend - Deuren met T-profiel  
Portes ouvrant vers l'intérieur - Portes avec traverse  
Doors inward opening - Doors with transom-mullion  
Türen nach innen öffnend - Türen mit T-profilsockel

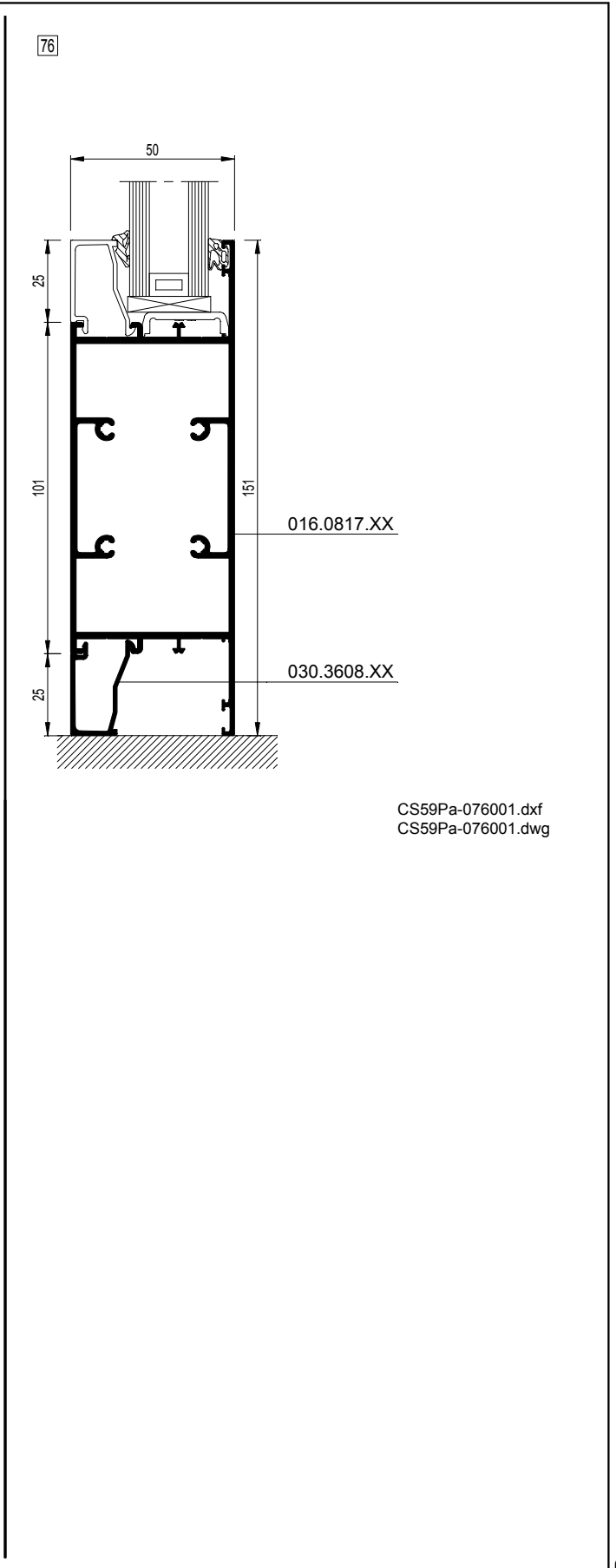
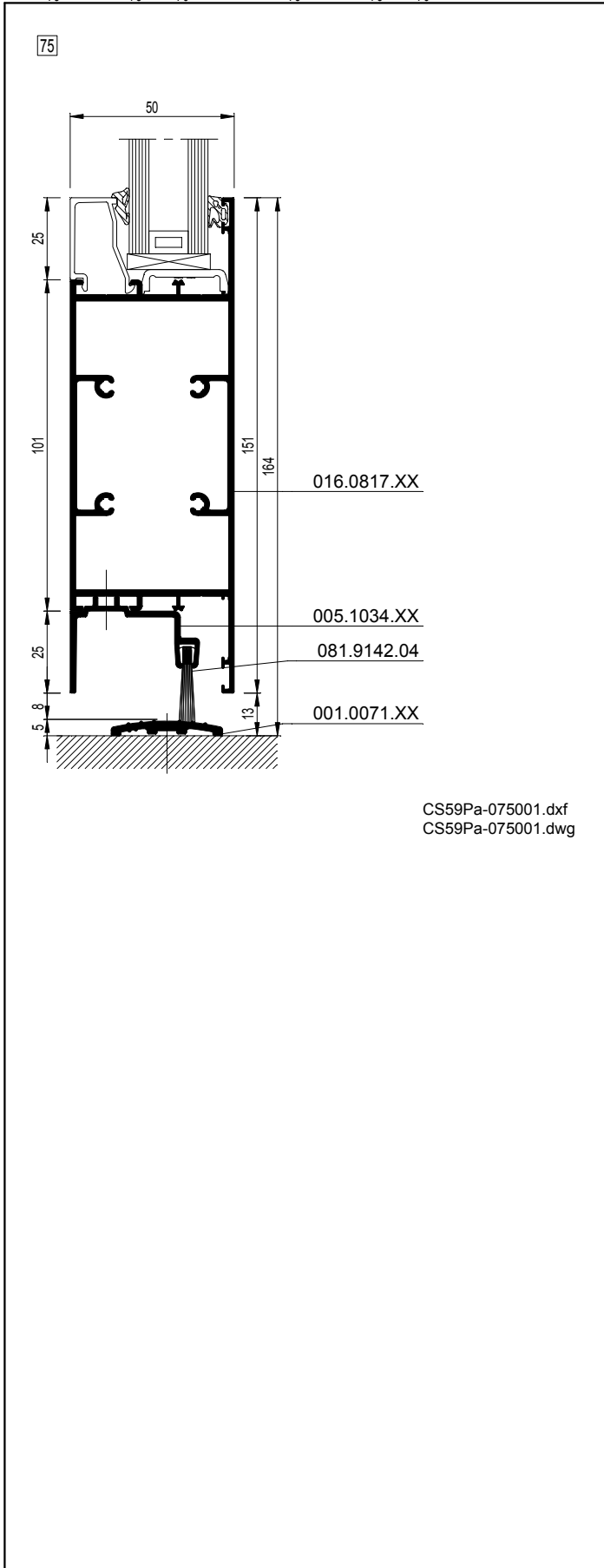
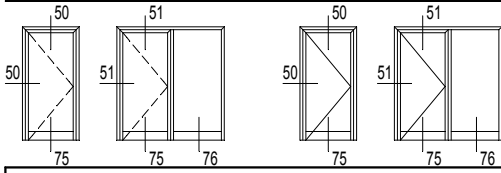

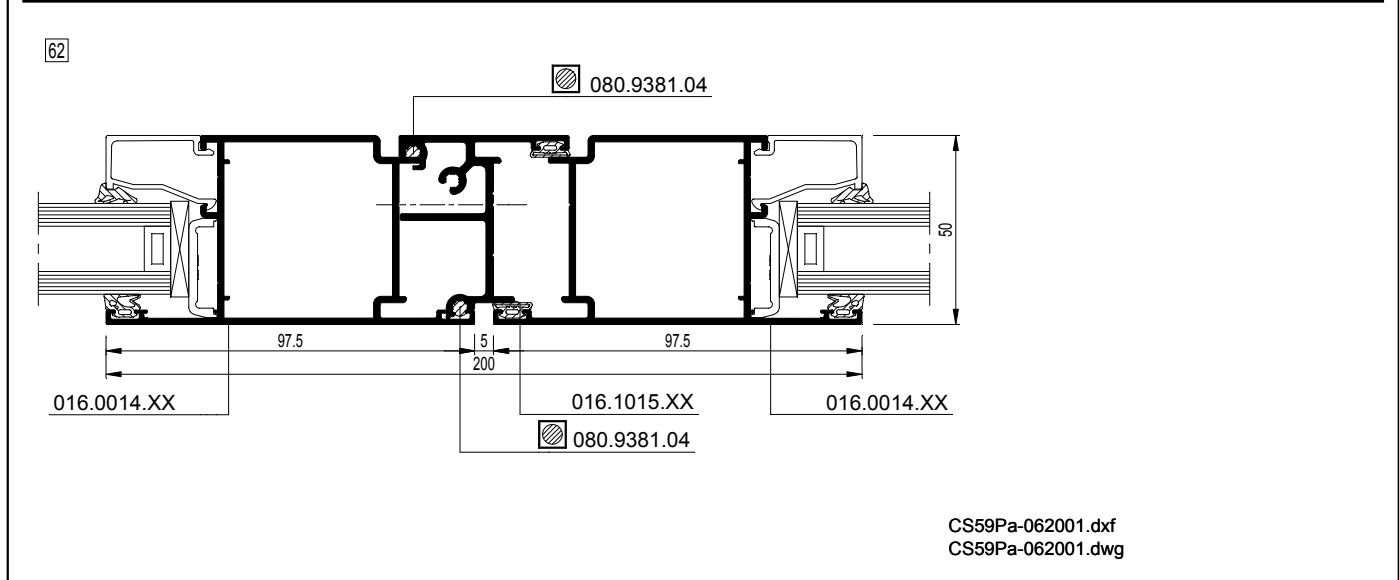
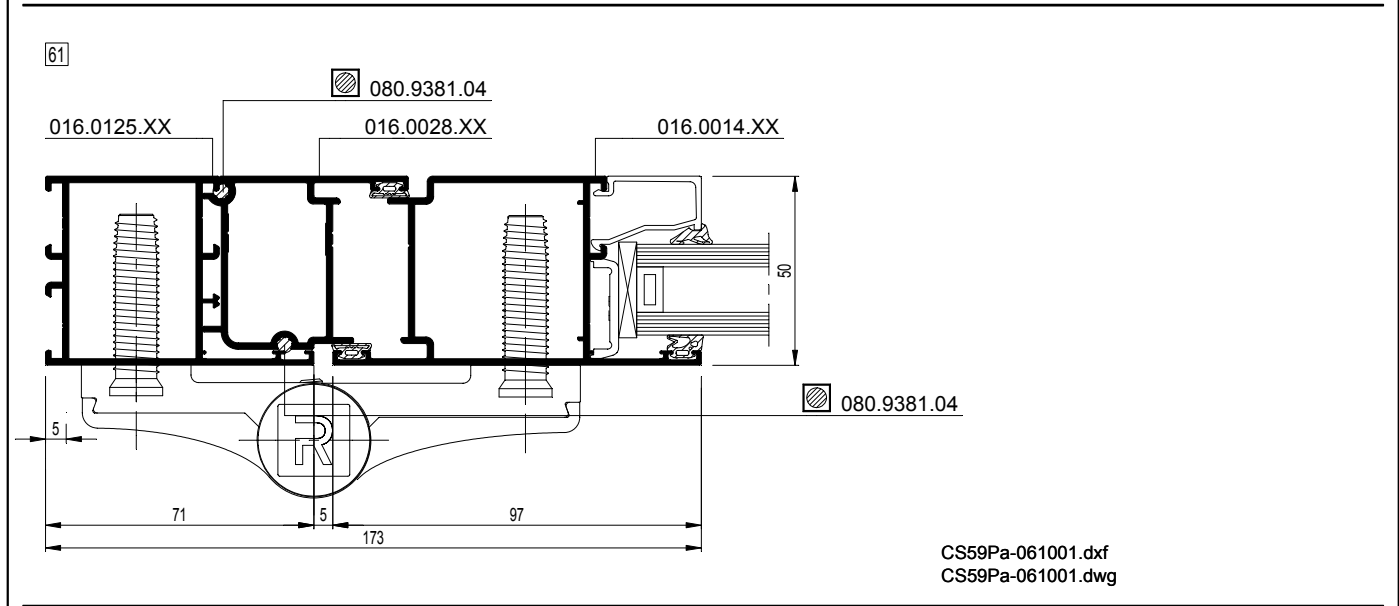
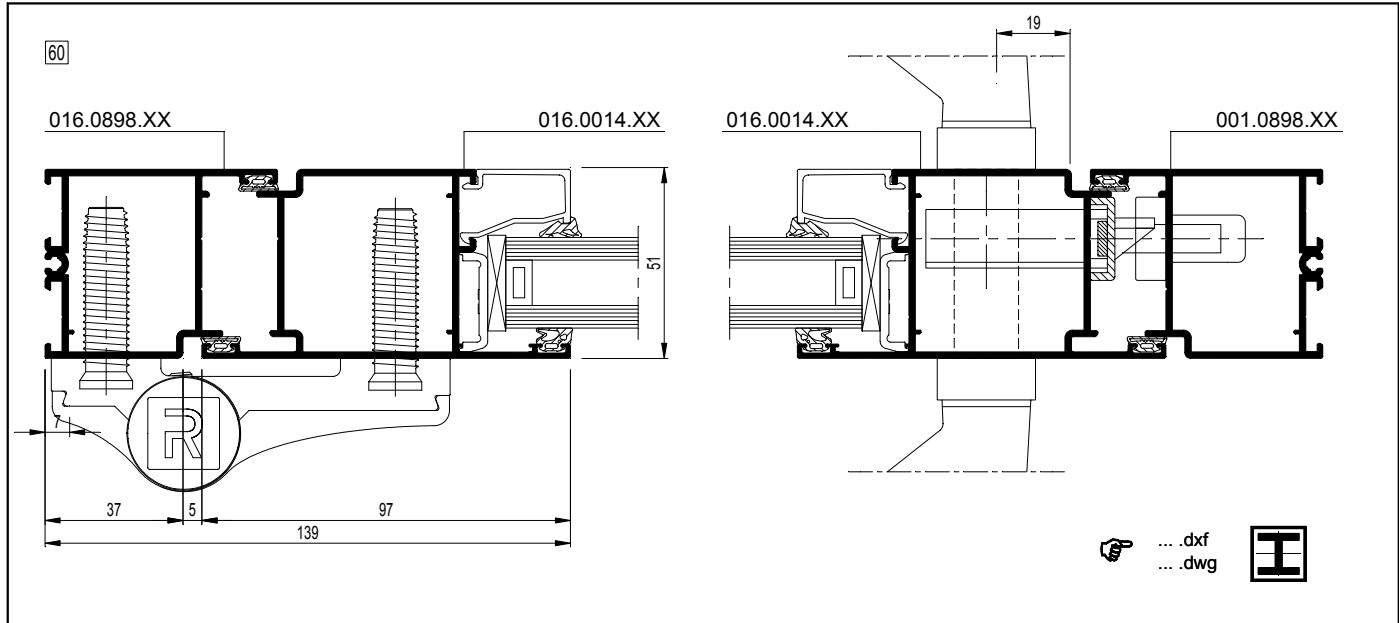
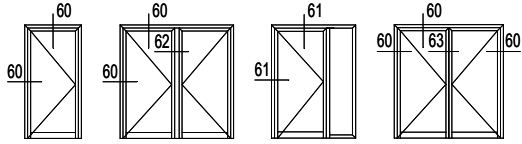



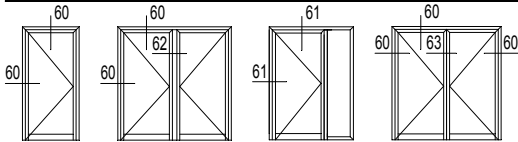

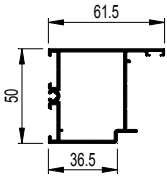

016.0898.XX

$I_x = 13.668 \text{ cm}^4$



 CS-59Pa-060001.dxf  
 CS-59Pa-060001.dwg

016.0026.XX

$I_x = 18.889 \text{ cm}^4$

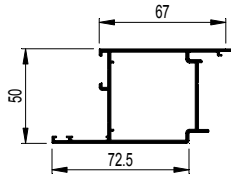

 CS-59Pa-060002.dxf  
 CS-59Pa-060002.dwg

 ZT

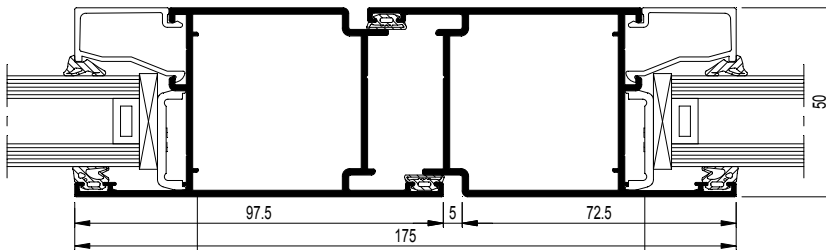

016.0014.XX

016.0026.XX

CS-59Pa-063001.dxf  
 CS-59Pa-063001.dwg

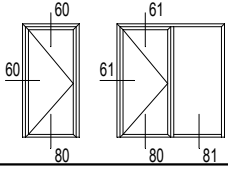

80

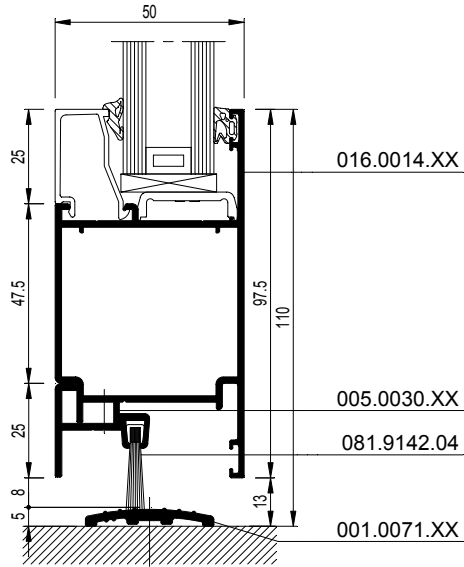

CS59Pa-080001.dxf  
 CS59Pa-080001.dwg

81

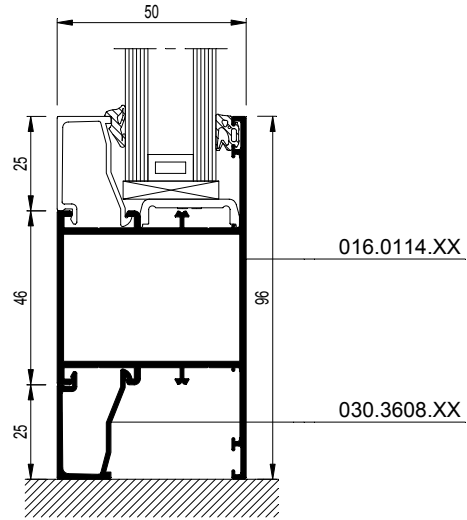

CS59Pa-081001.dxf  
 CS59Pa-081001.dwg

## CS 59Pa



### CS 59Pa Front (CS 59Pa-Fr)

Schuif-kipdeur

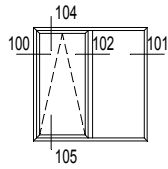

CS 59Pa-Fr - 102

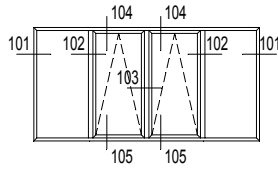

CS 59Pa-Fr - 103

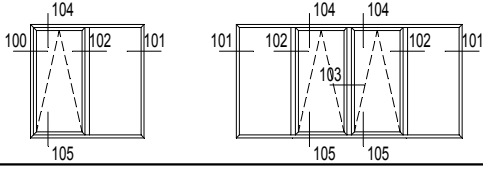

100 11

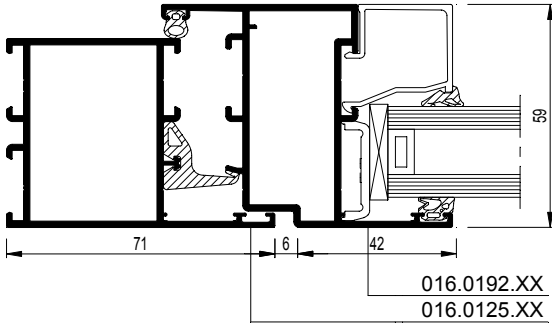

CS59Pa-100001.dxf  
 CS59Pa-100001.dwg

101 1

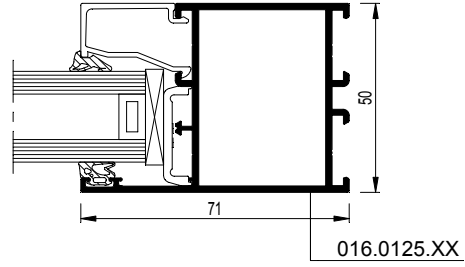

CS59Pa-101001.dxf  
 CS59Pa-101001.dwg

102 21

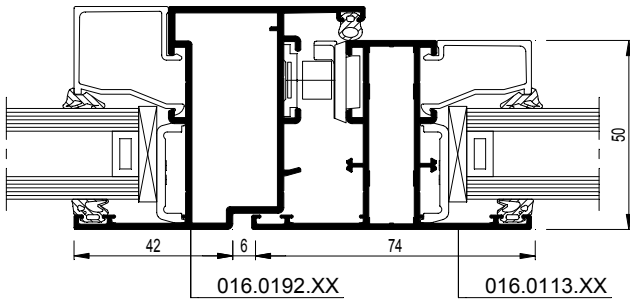

CS59Pa-102001.dxf  
 CS59Pa-102001.dwg

103 12

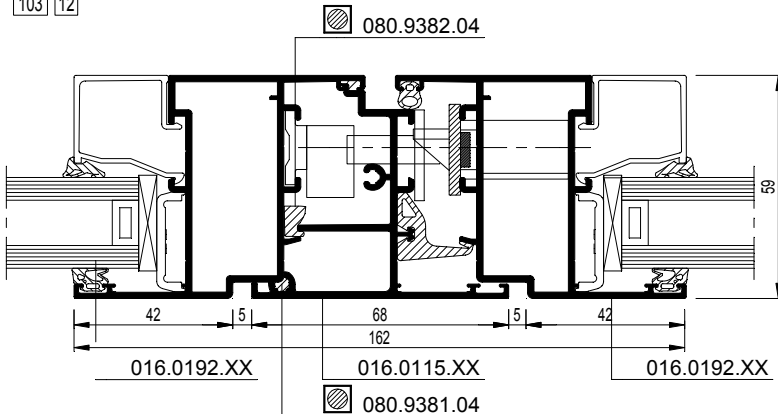

CS59Pa-103001.dxf  
 CS59Pa-103001.dwg

# CS 59Pa-Fr

Schuif-kipdeur  
Porte coulissante-battante  
Sliding tilt door  
Schiebe-kipptür

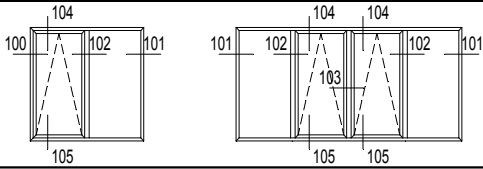

104

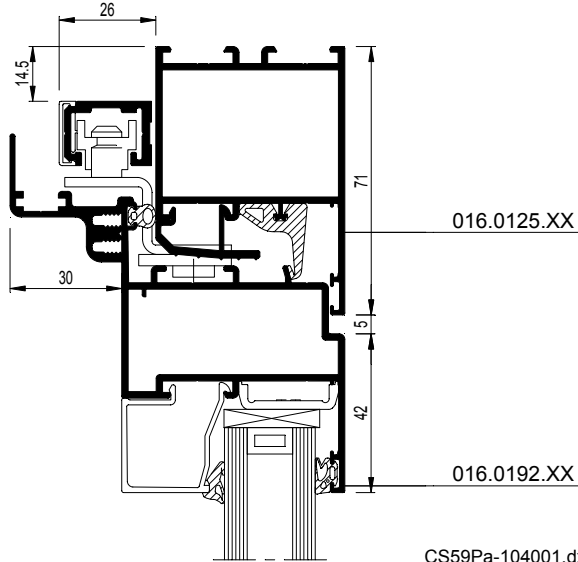

CS59Pa-104001.dxf  
CS59Pa-104001.dwg

105

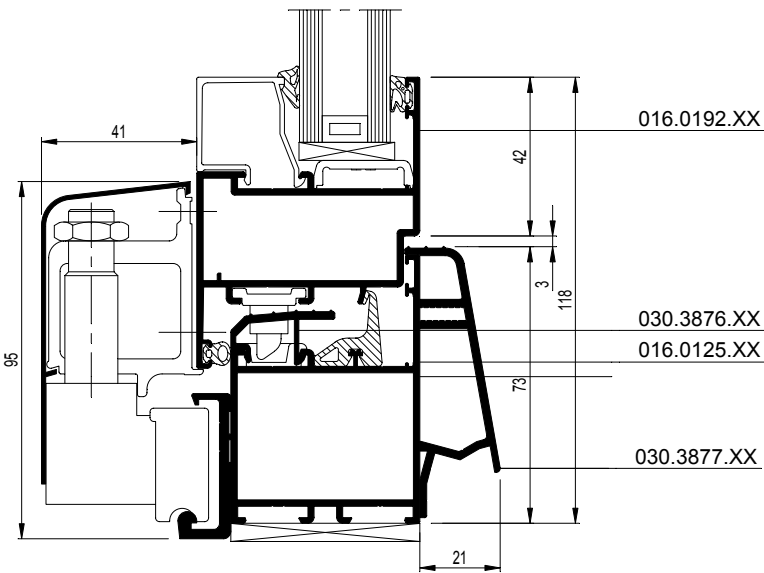

CS59Pa-105001.dxf  
CS59Pa-105001.dwg

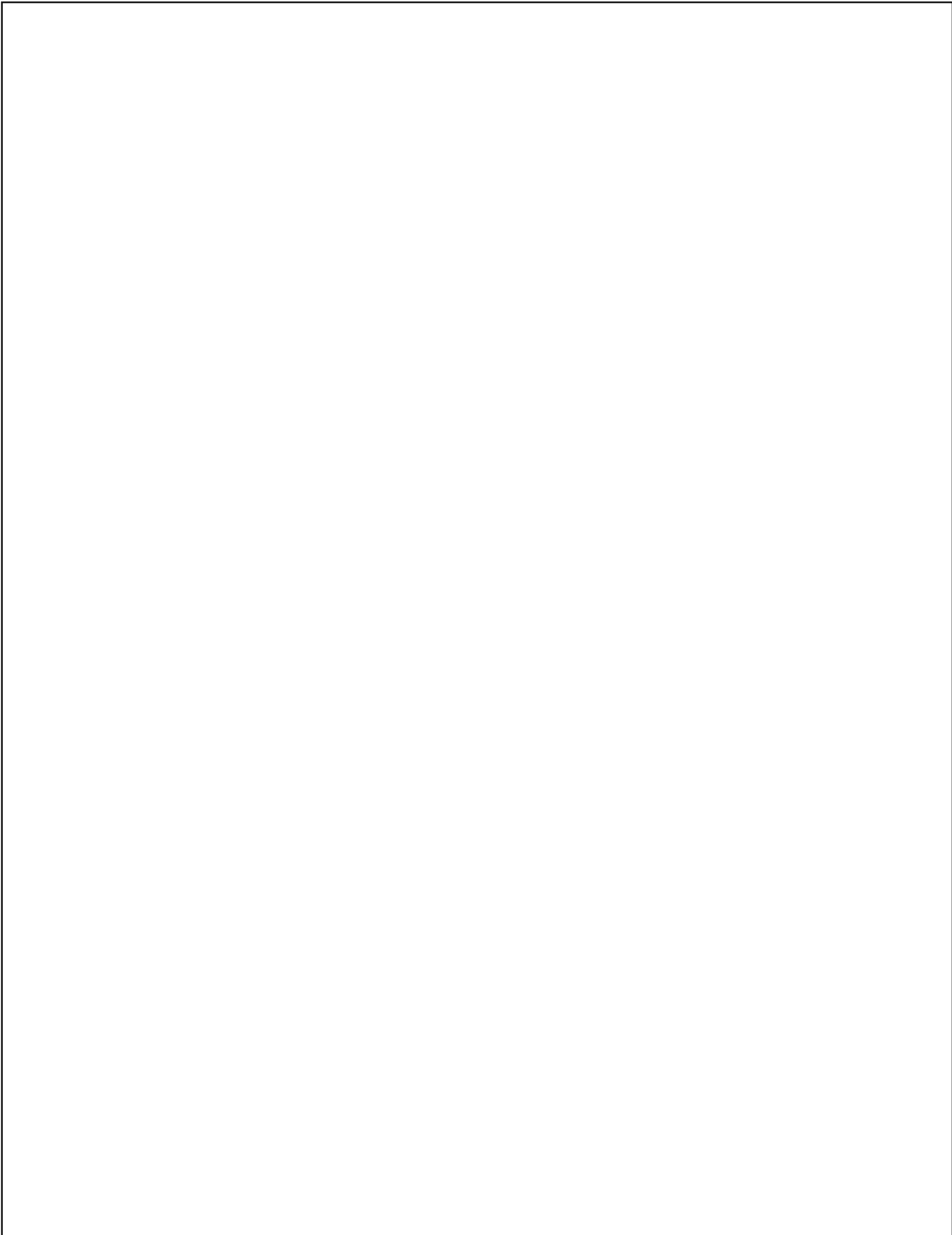



### CS 59Pa Automatic Sliding Door (CS 59Pa-AD)

Schuifdeuren

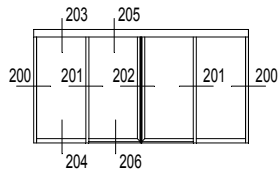

- CS 59Pa - 202
- CS 59Pa - 203
- CS 59Pa - 204

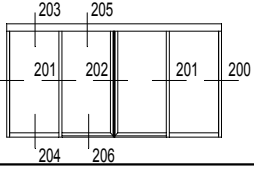

200

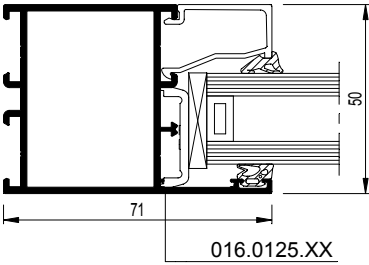

CS59Pa-200001.dxf  
CS59Pa-200001.dwg

201

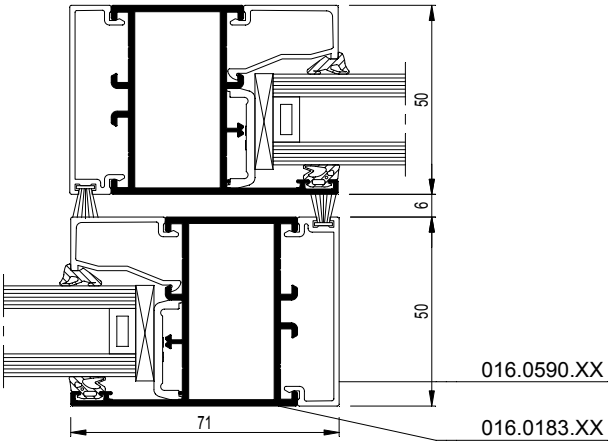

CS59Pa-201001.dxf  
CS59Pa-201001.dwg

202

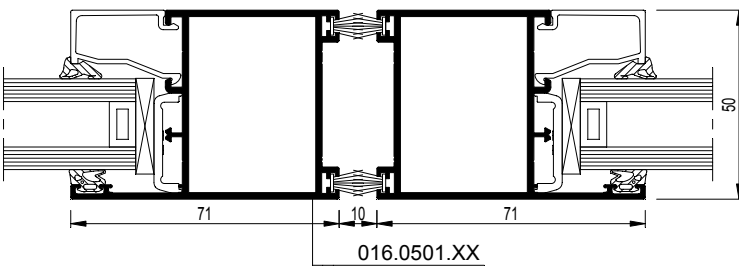

CS59Pa-202001.dxf  
CS59Pa-202001.dwg



# CS 59Pa-AD

Automatische schuifdeuren  
Portes coulissantes automatiques  
Automatic sliding door  
Automatische Schiebetüren

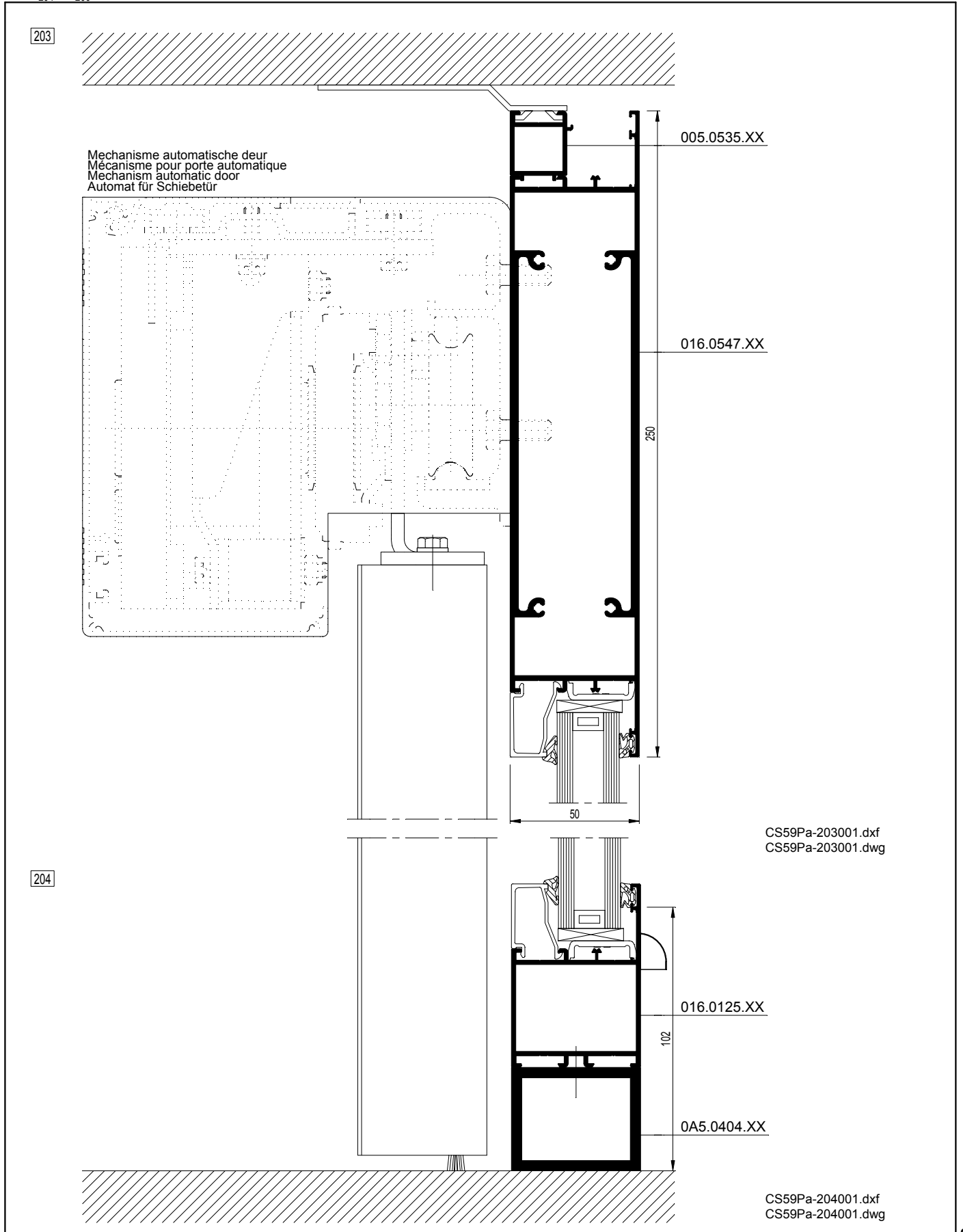
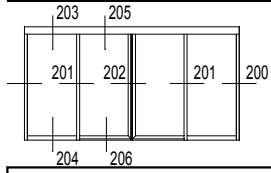

# CS 59Pa-AD

Automatische schuifdeuren  
Portes coulissantes automatiques  
Automatic sliding door  
Automatische Schiebetüren

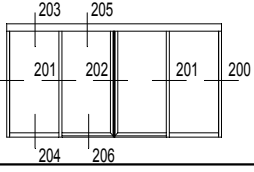

205

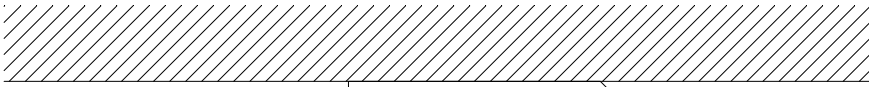

Mechanisme automatische deur  
Mécanisme pour porte automatique  
Mechanism automatic door  
Automat für Schiebetür

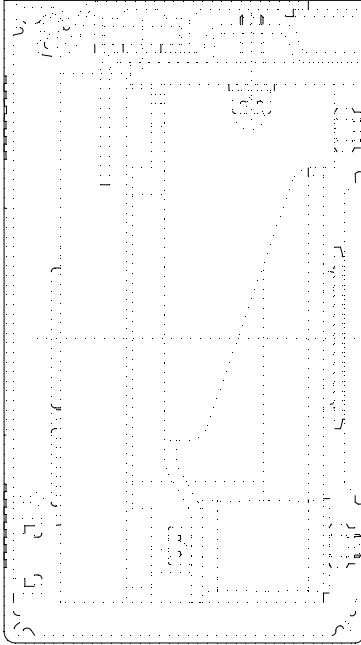

016.0183.XX

71

71

50

6

50

005.0535.XX

250

016.0547.XX

001.0599.XX

016.0591.XX

CS59Pa-205001.dxf  
CS59Pa-205001.dwg

206

016.0120.XX

96

96

016.1534.XX

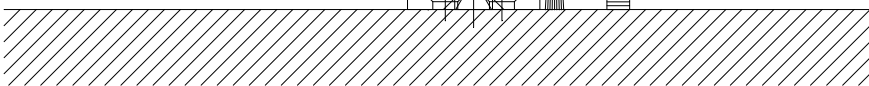

CS59Pa-206001.dxf  
CS59Pa-206001.dwg



## CS 59Pa Swing Door (CS 59Pa-SD)

### 1 Deur met vingerbeveiliging

#### Kozijndorpelvoor deur met vingerbeveiliging

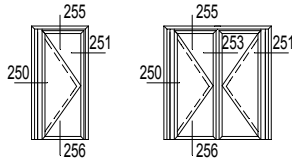

CS 59Pa - 250  
CS 59Pa - 251

#### Vloerveer deur met vingerbeveiliging

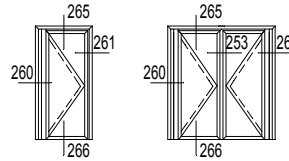

CS 59Pa - 256  
CS 59Pa - 257

### 2 Deur zonder vingerbeveiliging

#### Kozijndorpelvoor deur zonder vingerbeveiliging

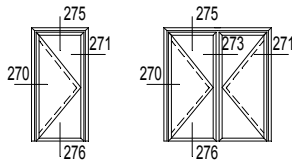

CS 59Pa - 260  
CS 59Pa - 261

#### vloerveer deur zonder vingerbeveiliging

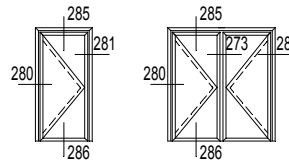

CS 59Pa - 266  
CS 59Pa - 267

# CS 59Pa-SD

Deur met vingerbeveiliging - Kozijndorpelveer deur met vingerbeveiliging  
 Porte avec anti-pince-doigts - Pivot de frein aerien porte avec anti-pince-doigts  
 Door with finger protection - Overhead closer door with finger protection  
 Einzelne Tür mit Fingerschutz - Rohrtuerschliesser Tür mit Fingerschutz

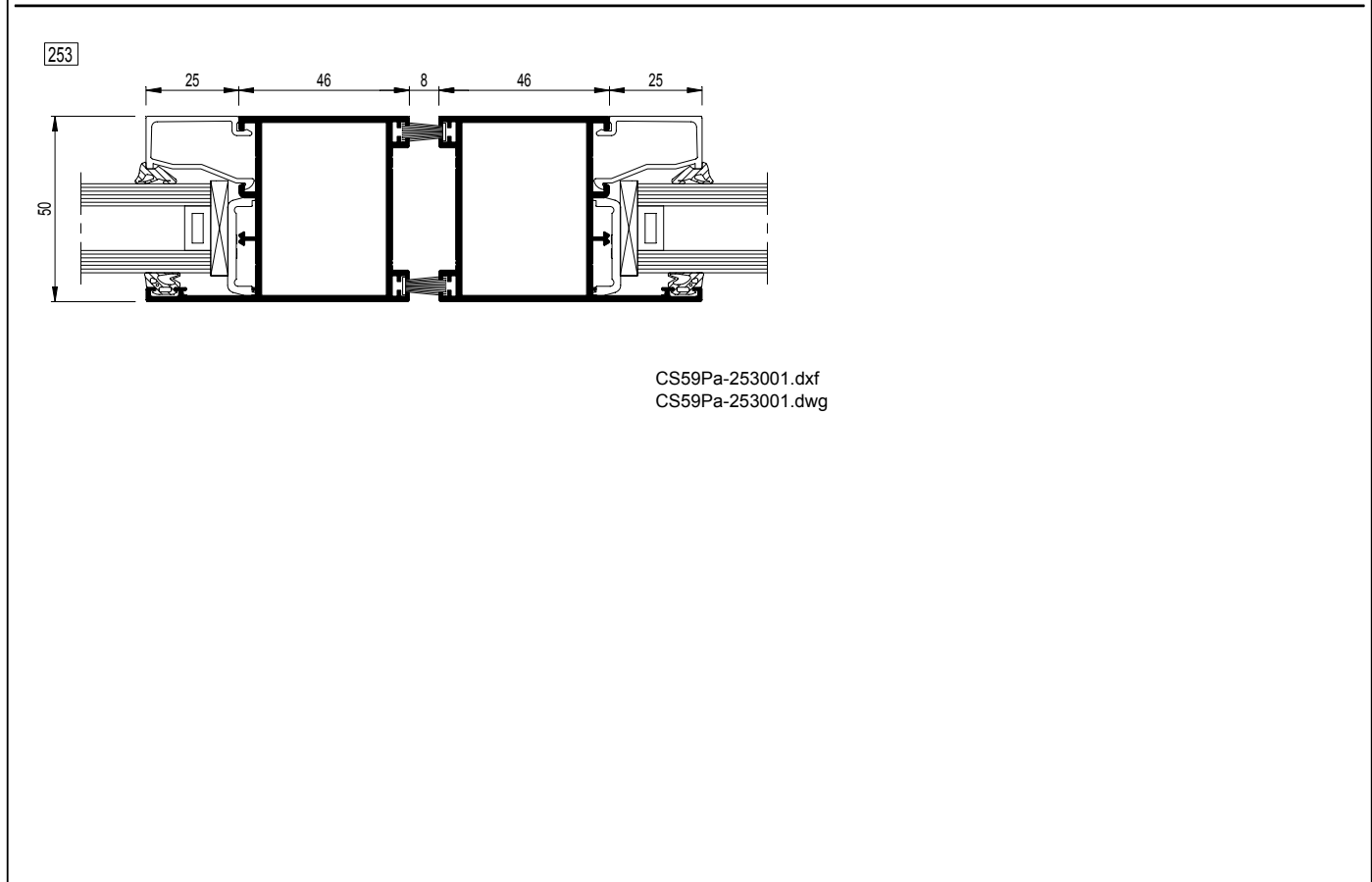
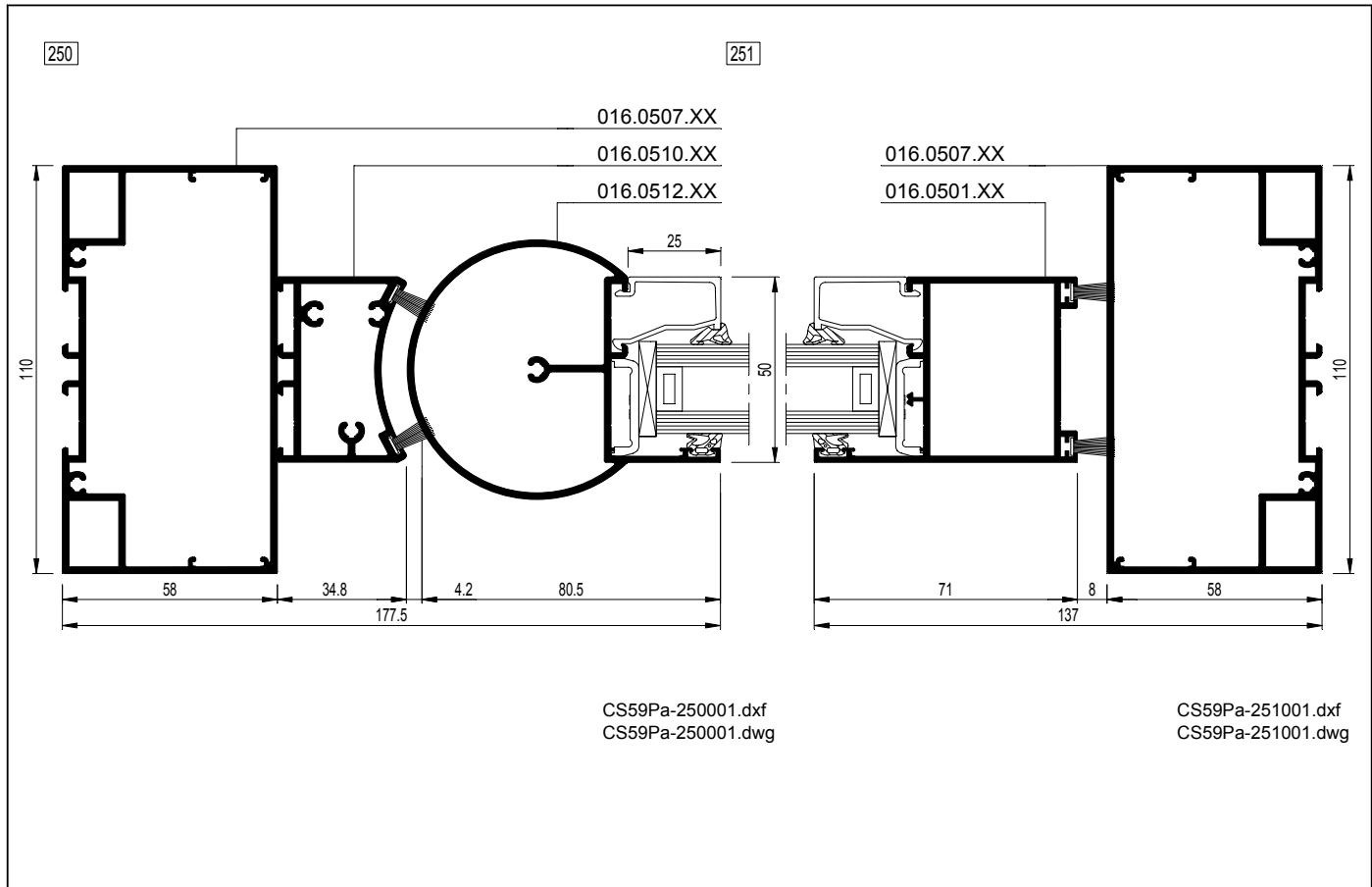
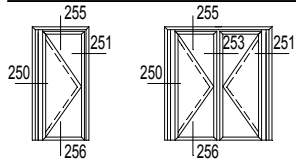

# CS 59Pa-SD

Deur met vingerbeveiliging - Kozijndorpelveer deur met vingerbeveiliging  
Porte avec anti-pince-doigts - Pivot de frein aerien porte avec anti-pince-doigts  
Door with finger protection - Overhead closer door with finger protection  
Einzelne Tür mit Fingerschutz - Rohrtuerschliesser Tür mit Fingerschutz

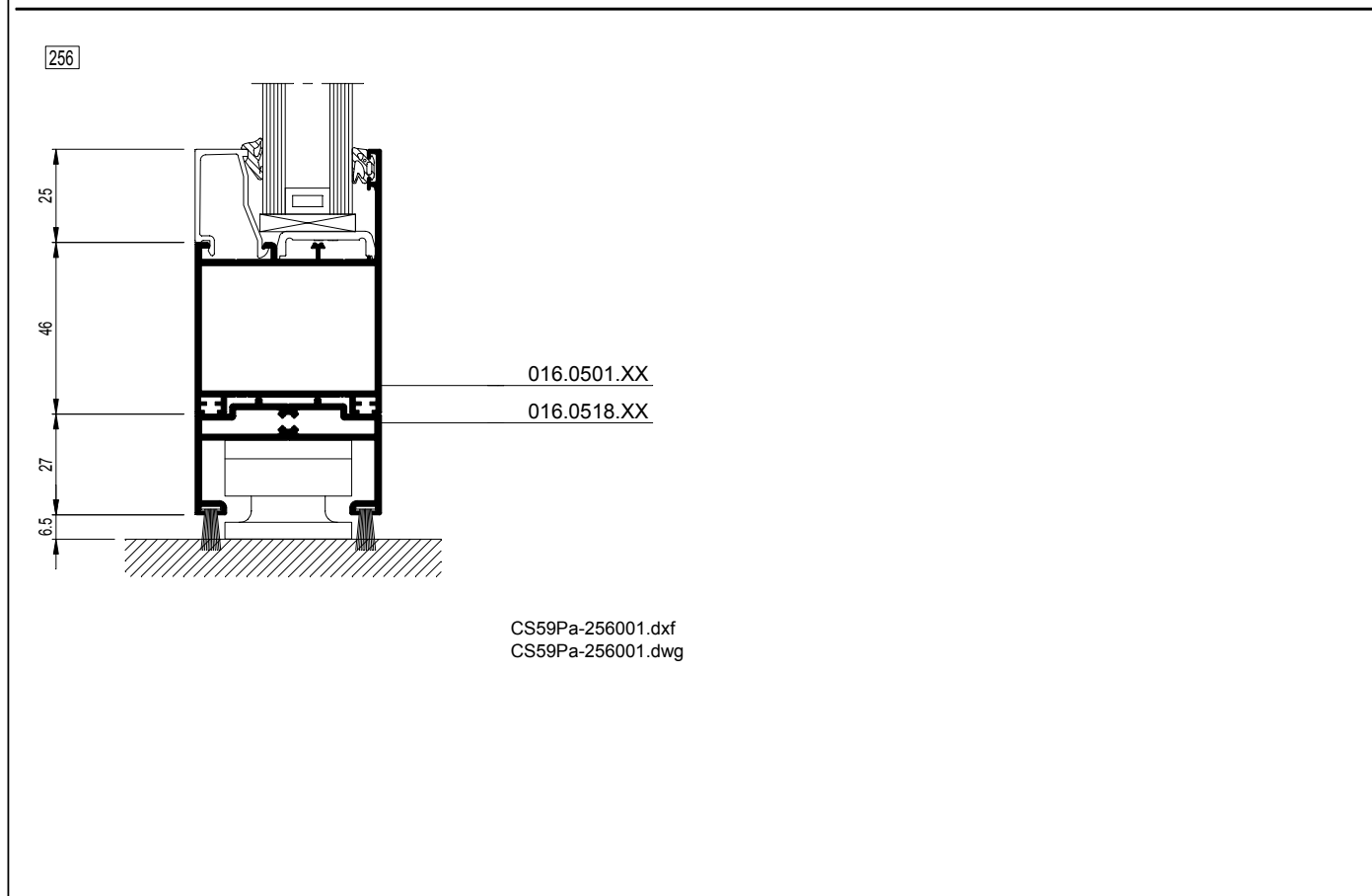
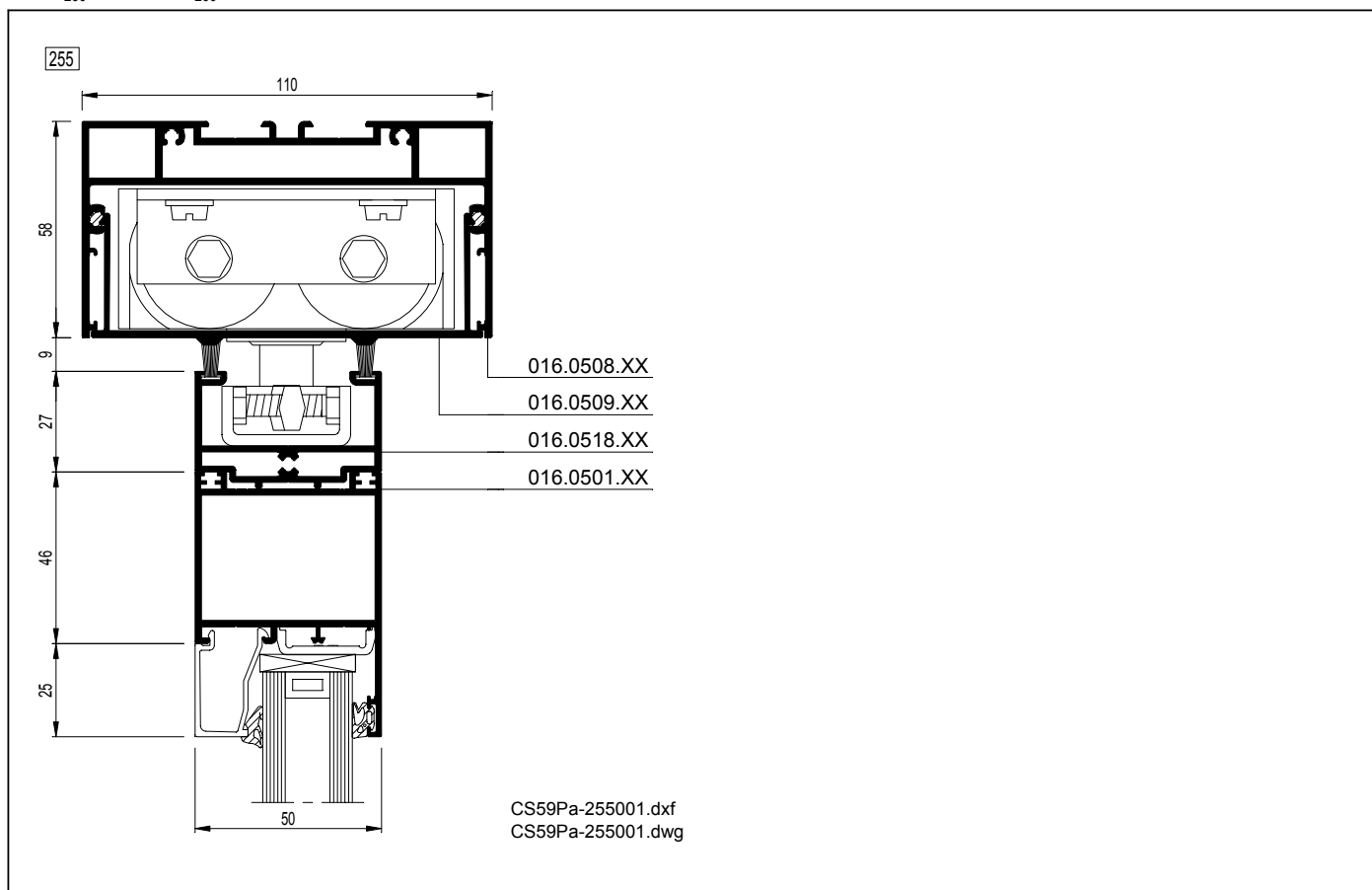
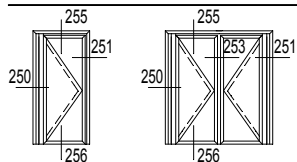

# CS 59Pa-SD

Deur met vingerbeveiliging - Vloerveer deur met vingerbeveiliging  
Porte avec anti-pince-doigts - Pivot de frein au sol porte avec anti-pince-doigts  
Door with finger protection - Floor closer door with finger protection  
Einzelne Tür mit Fingerschutz - Bodentuerschliesser Tür mit Fingerschutz

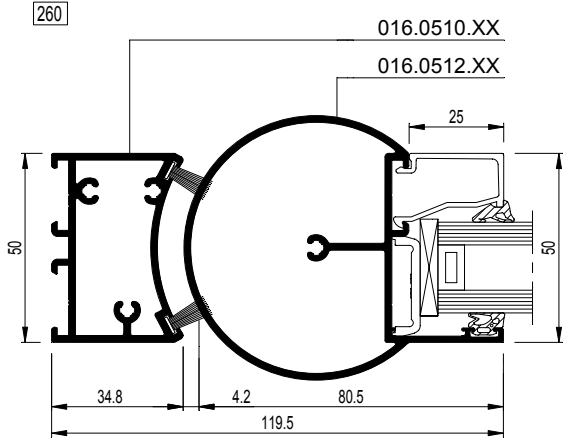
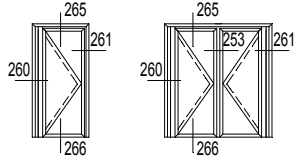

CS59Pa-260001.dxf  
CS59Pa-260001.dwg

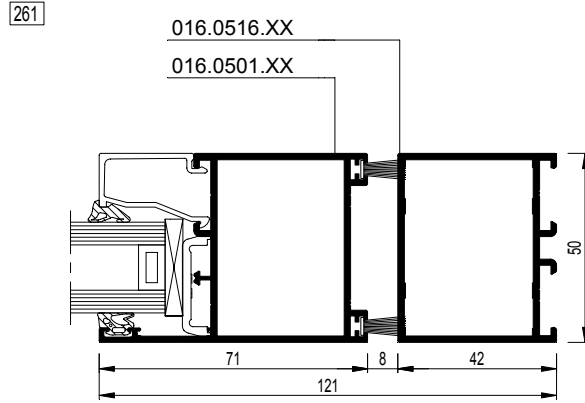

CS59Pa-261001.dxf  
CS59Pa-261001.dwg

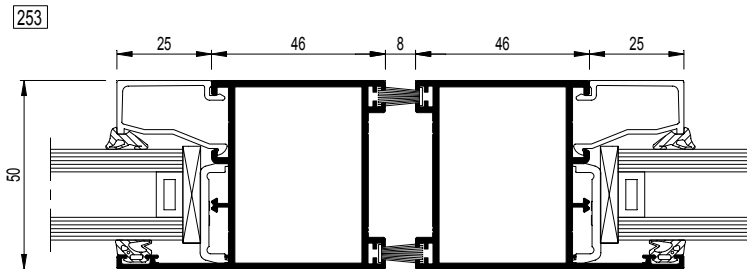

CS59Pa-253001.dxf  
CS59Pa-253001.dwg

# CS 59Pa-SD

Deur met vingerbeveiliging - Kozjindorpelveer deur met vingerbeveiliging  
Porte avec anti-pince-doigts - Pivote de frein aerien porte avec anti-pince-doigts  
Door with finger protection - Overhead closer door with finger protection  
Einzelne Tür mit Fingerschutz - Rohrtuerschliesser Tür mit Fingerschutz

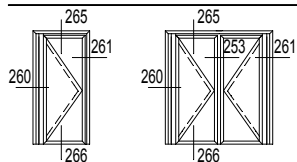

265

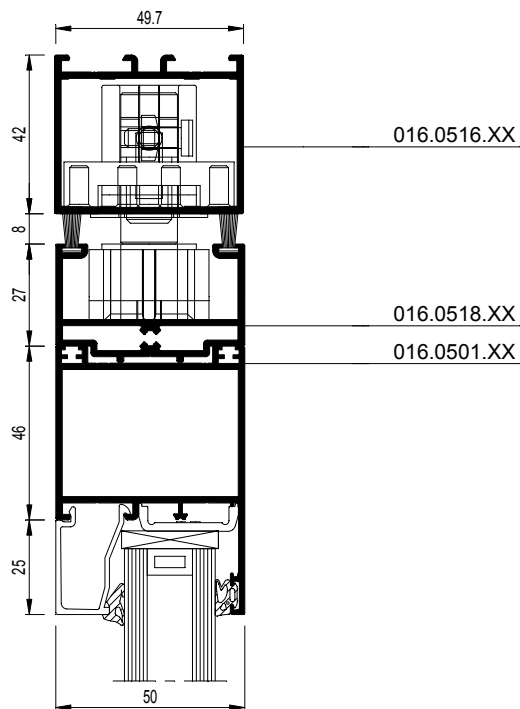

CS59Pa-265001.dxf  
CS59Pa-265001.dwg

266

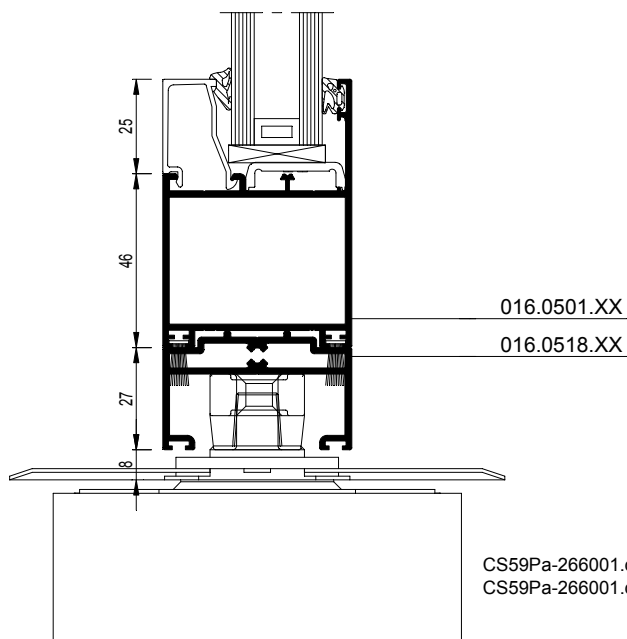

CS59Pa-266001.dxf  
CS59Pa-266001.dwg

# CS 59Pa-SD

Deur zonder vingerbeveiliging - Kozijndorpelveer deur zonder vingerbeveiliging  
 Porte sans anti-pince-doigts - Pivot de frein aerien porte sans anti-pince-doigts  
 Door without finger protection - Overhead closer door without finger protection  
 Einzelne Tür ohne Fingerschutz - Rohrtuerschliesser Tür ohne Fingerschutz

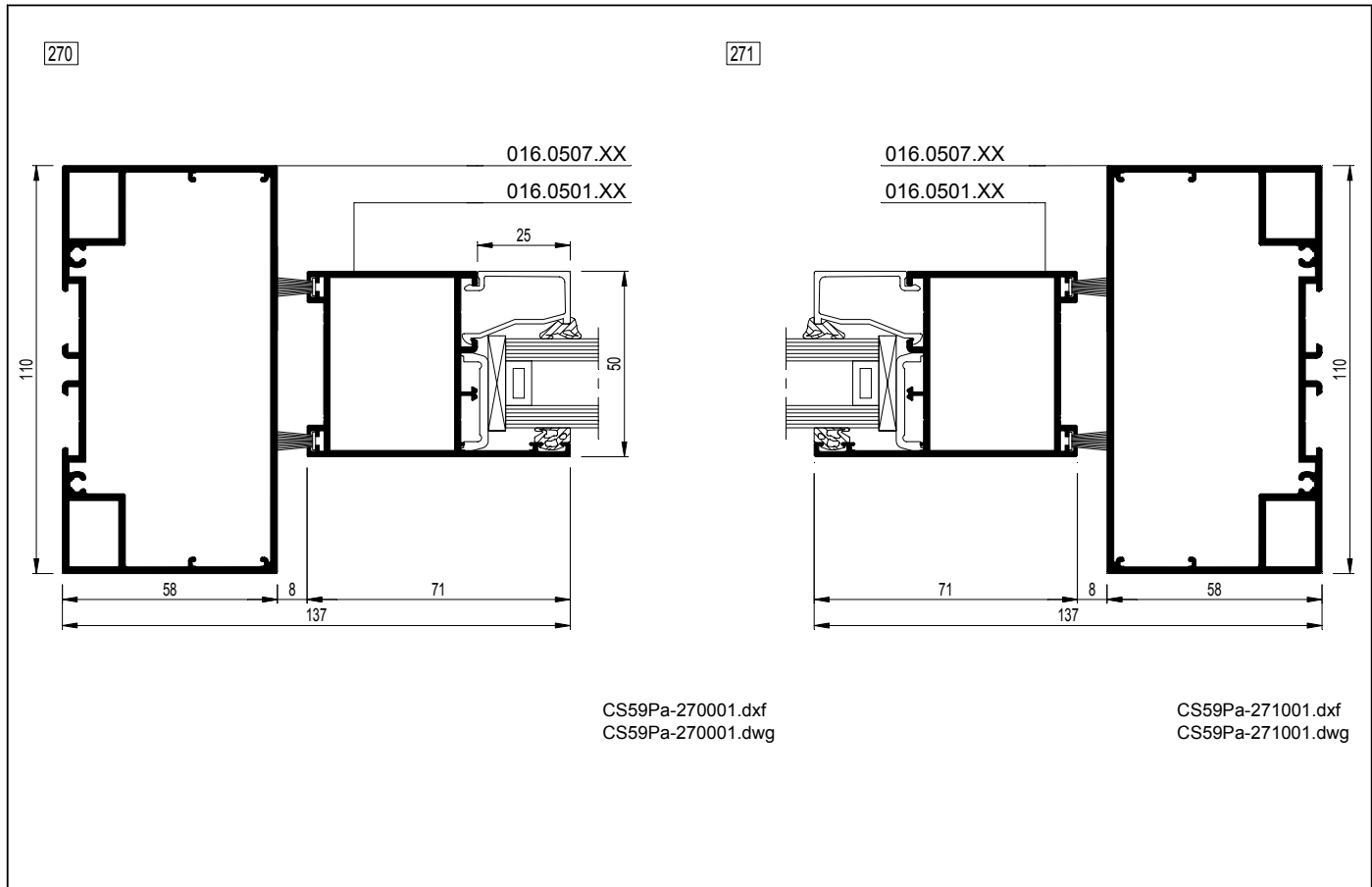
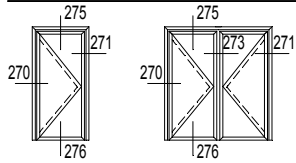

CS59Pa-270001.dxf  
 CS59Pa-270001.dwg

CS59Pa-271001.dxf  
 CS59Pa-271001.dwg

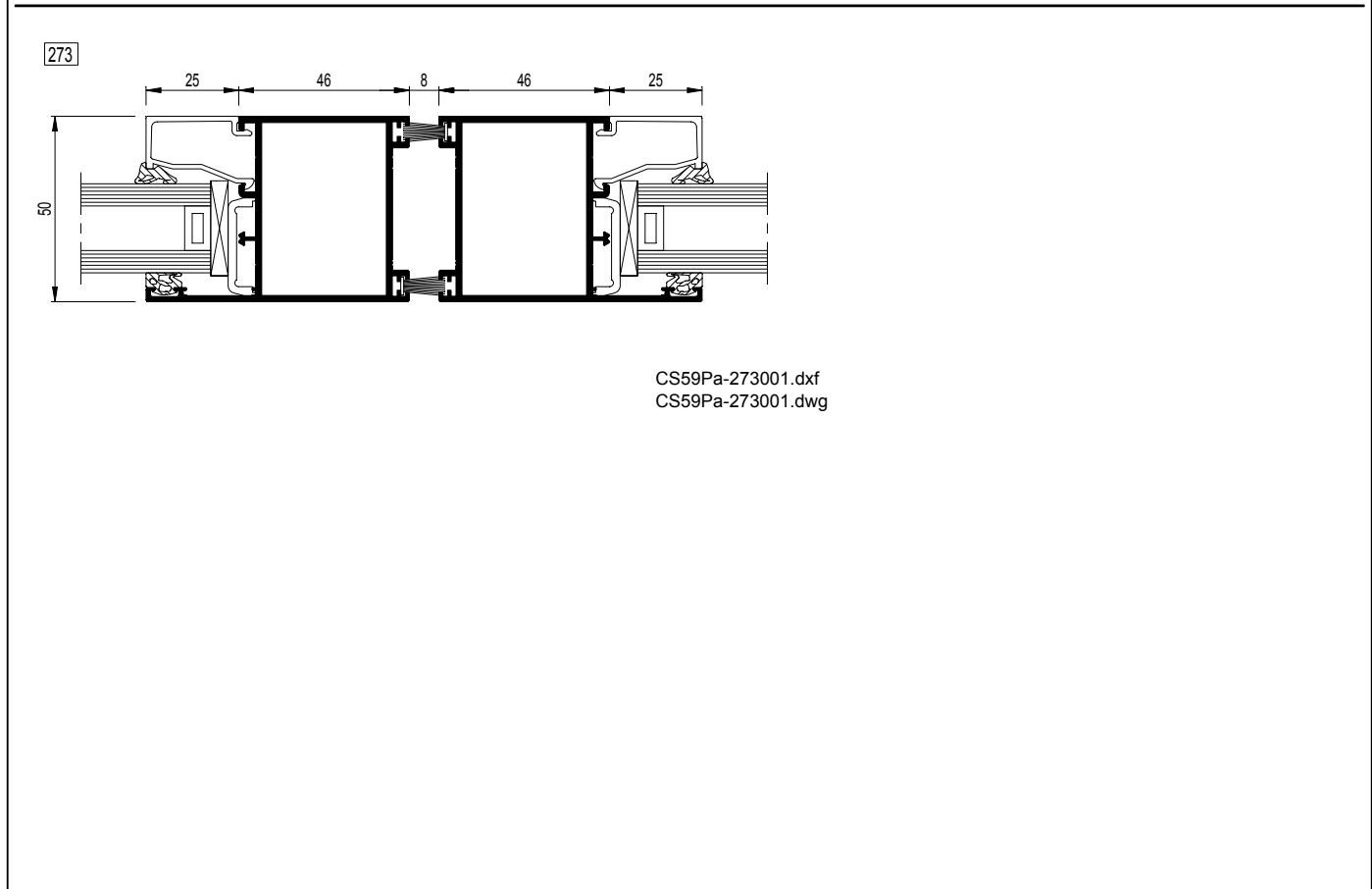

CS59Pa-273001.dxf  
 CS59Pa-273001.dwg



# CS 59Pa-SD

Deur zonder vingerbeveiliging - Kozijndorpelveer deur zonder vingerbeveiliging  
 Porte sans anti-pince-doigts - Pivote de frein aerien porte sans anti-pince-doigts  
 Door without finger protection - Overhead closer door without finger protection  
 Einzelne Tür ohne Fingerschutz - Rohrtuerschliesser Tür ohne Fingerschutz

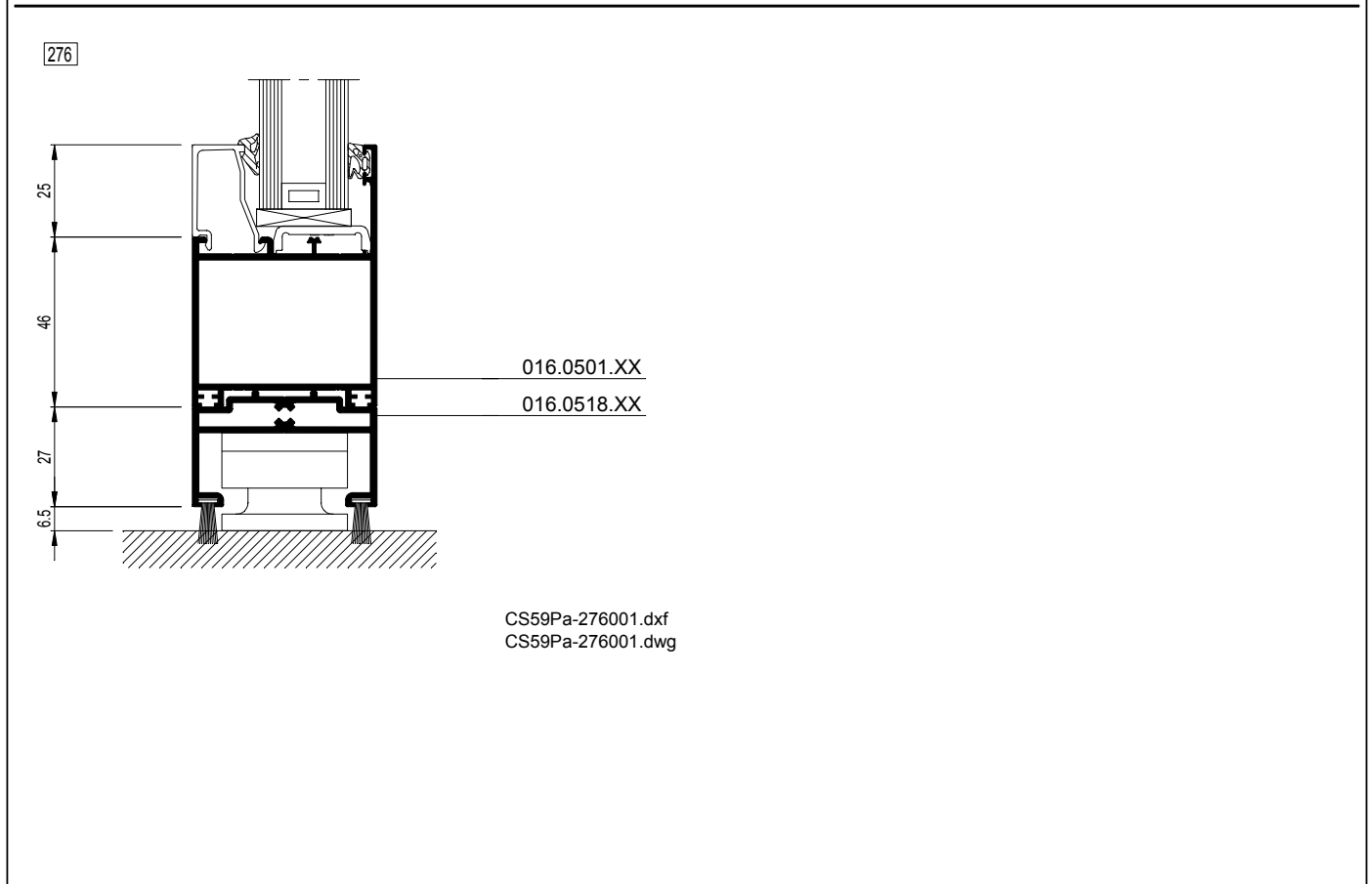
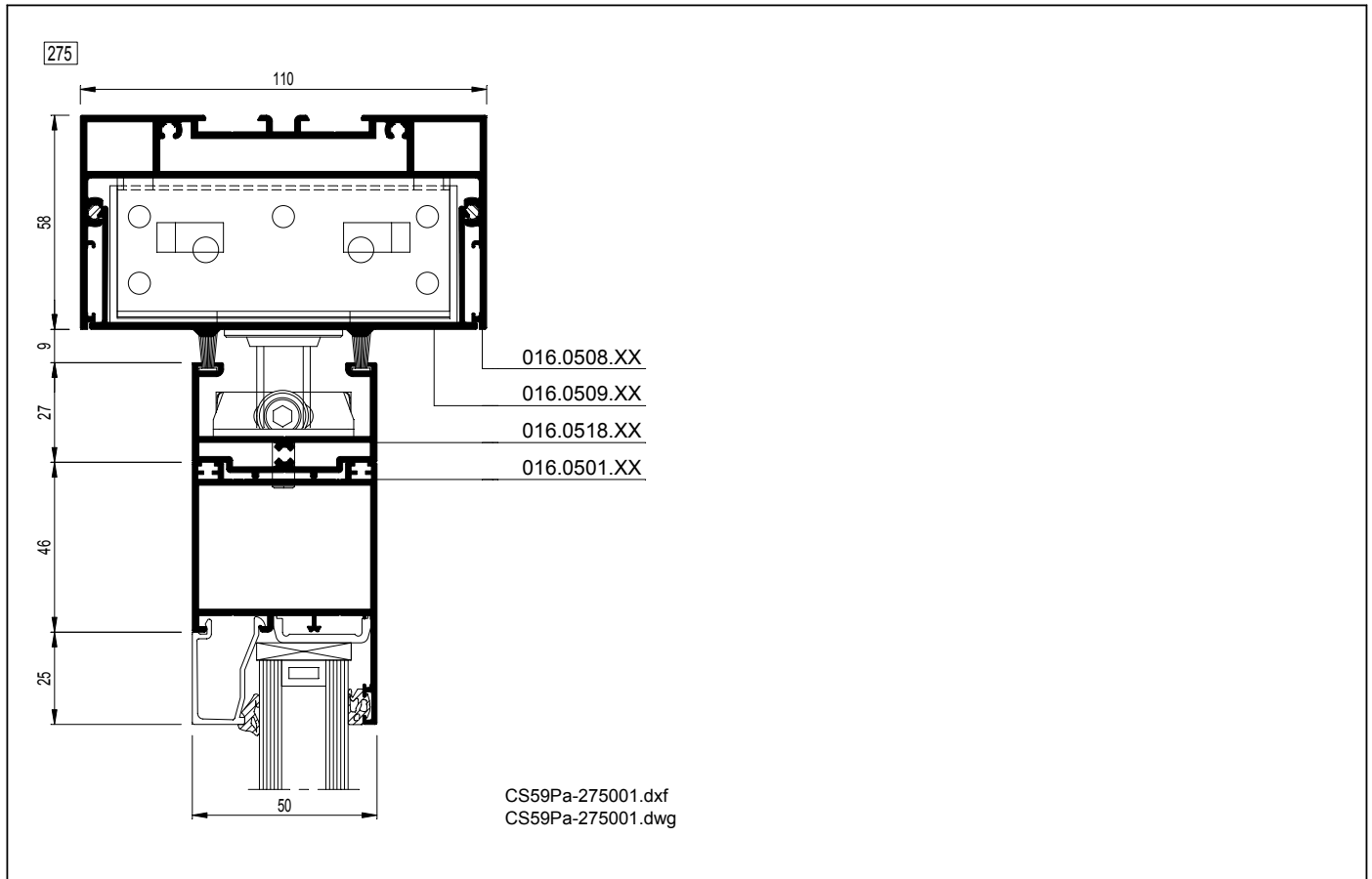
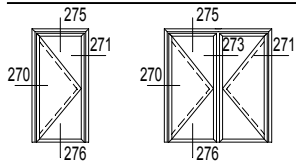

# CS 59Pa-SD

Deur zonder vingerbeveiliging - Vloerveer deur zonder vingerbeveiliging  
 Porte sans anti-pince-doigts - Pivot de frein au sol porte sans anti-pince-doigts  
 Door without finger protection - Floor closer door without finger protection  
 Einzelne Tür ohne Fingerschutz - Bodentuerschliesser Tür ohne Fingerschutz

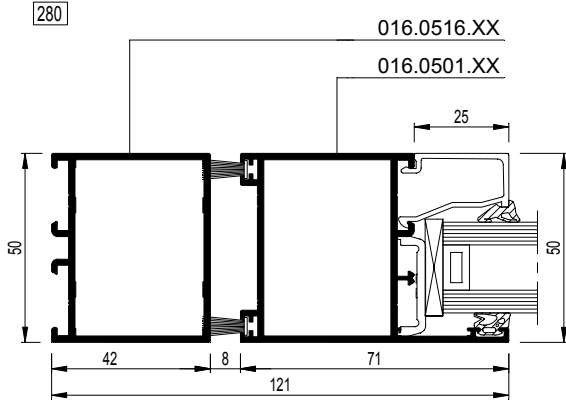
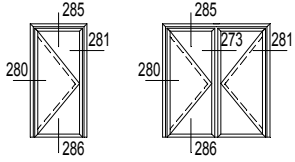

CS59Pa-280001.dxf  
 CS59Pa-280001.dwg

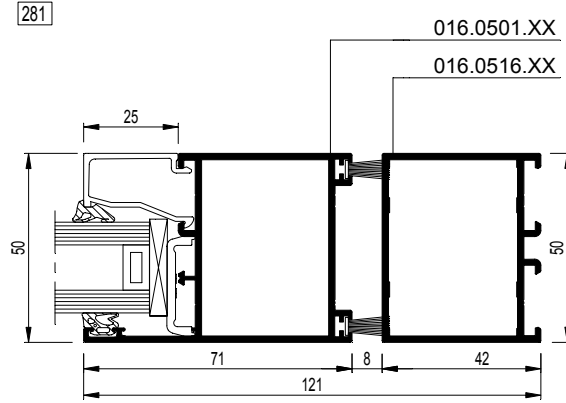

CS59Pa-281001.dxf  
 CS59Pa-281001.dwg

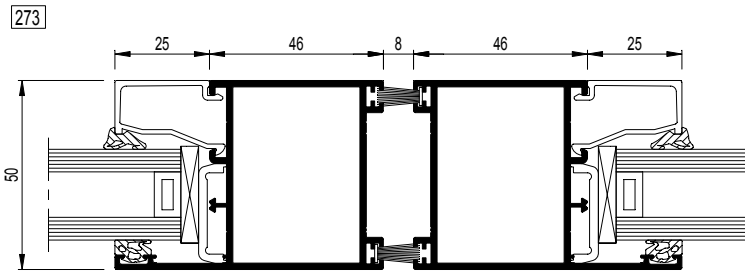

CS59Pa-273001.dxf  
 CS59Pa-273001.dwg

# CS 59Pa-SD

Deur zonder vingerbeveiliging - Vloerveer deur zonder vingerbeveiliging  
Porte sans anti-pince-doigts - Pivot de frein au sol porte sans anti-pince-doigts  
Door without finger protection - Floor closer door without finger protection  
Einzelne Tür ohne Fingerschutz - Bodentuerschliesser Tür ohne Fingerschutz

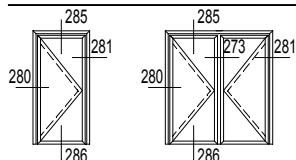

285

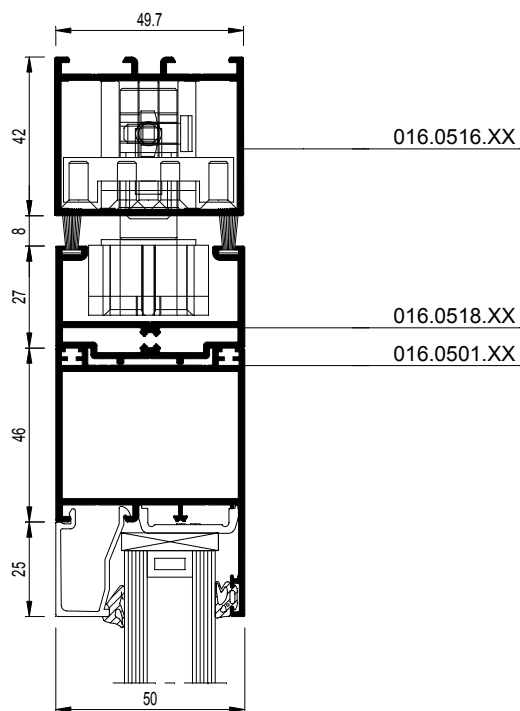

CS59Pa-285001.dxf  
CS59Pa-285001.dwg

286

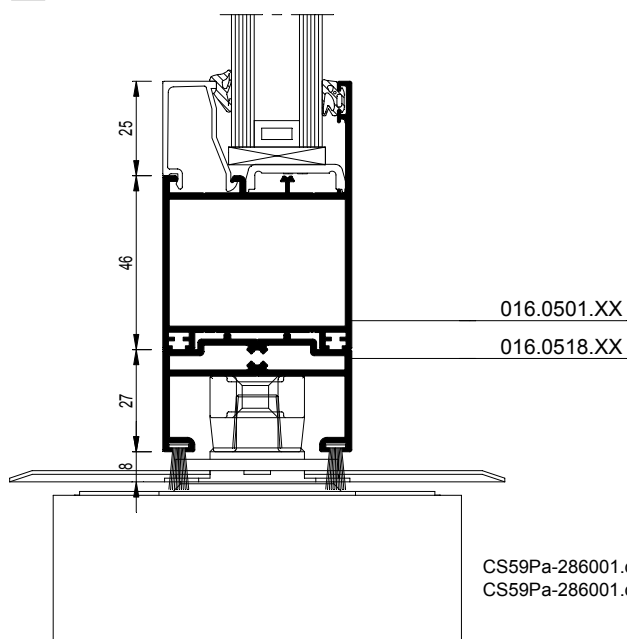

CS59Pa-286001.dxf  
CS59Pa-286001.dwg

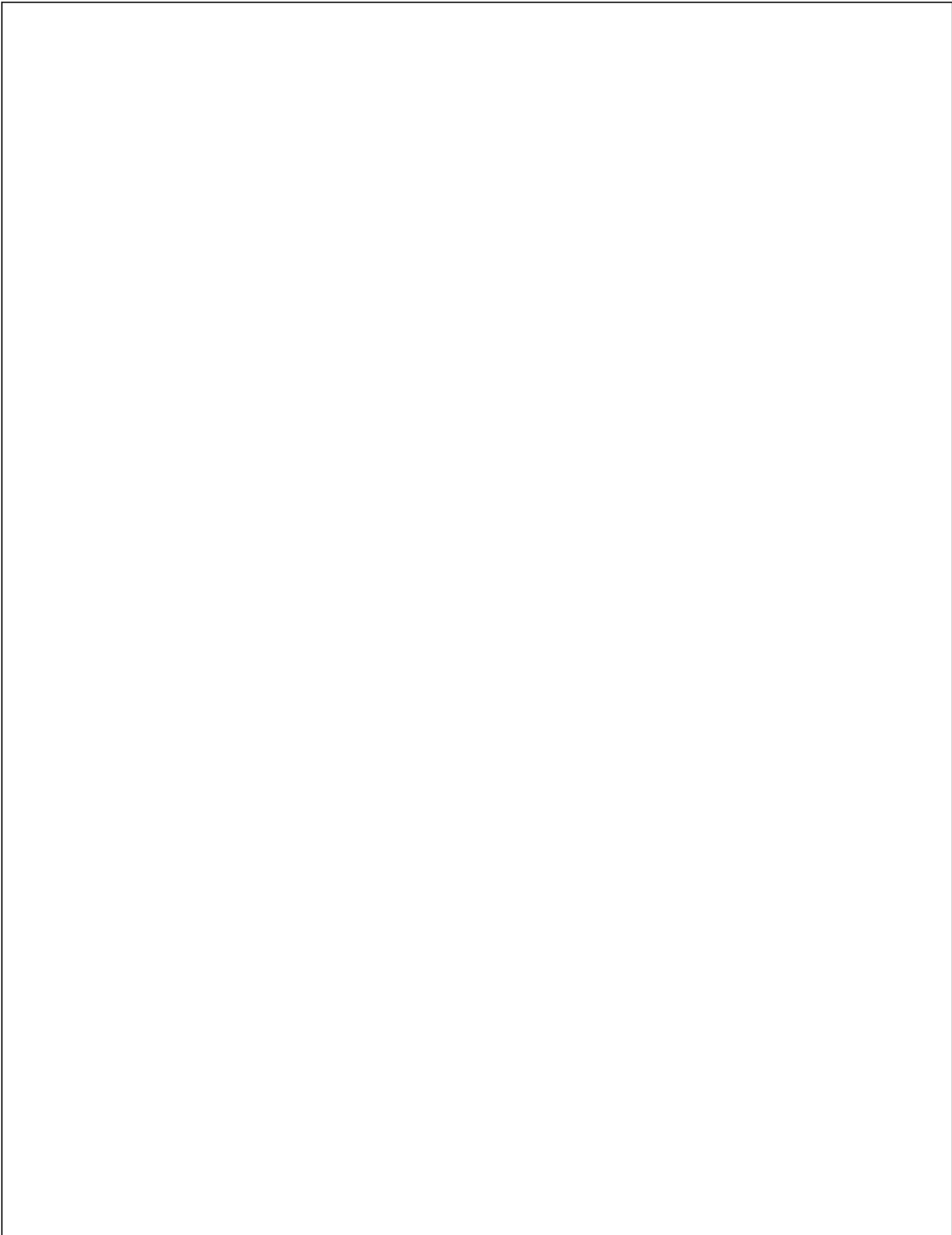

## CS 59Pa



### CS 59Pa Clampable Door (CS 59Pa-CD)

#### 1 Deuren naar binnen draaiend

Naar binnen opengaande deuren

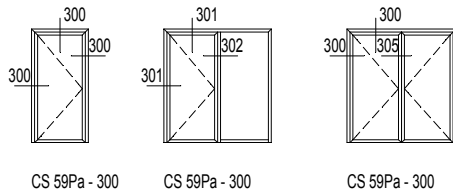

Naar binnen draaiende deuren met deurvleugel rondom geperst

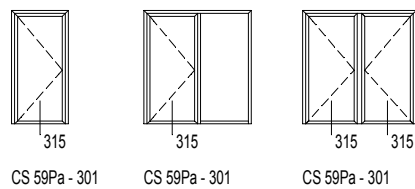

Deuren met T-profiel

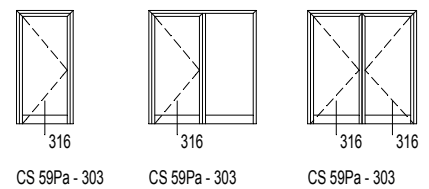

#### 2 Deuren naar buiten draaiend

Naar buiten opengaande deuren

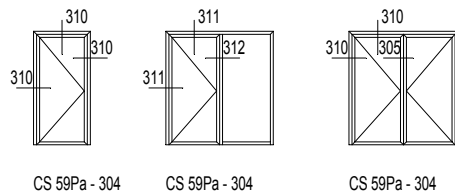

Naar buiten draaiende deuren met deurvleugel rondom geperst

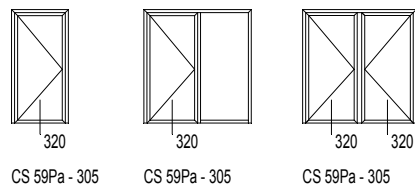

Deuren met T-profiel

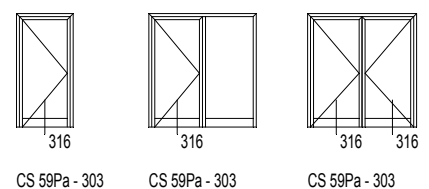

# CS 59Pa-CD

Deuren naar binnen draaiend - Naar binnen opengaande deuren  
 Portes ouvrant vers l'intérieur - Portes ouvrant vers l'intérieur  
 Doors inward opening - Inward opening doors  
 Türen nach innen öffnend - Nach innen öffnende Türen

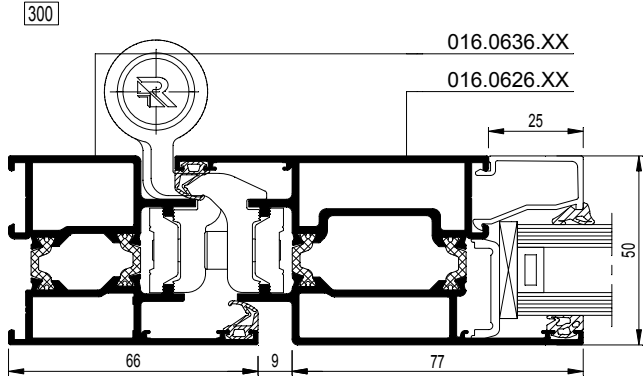
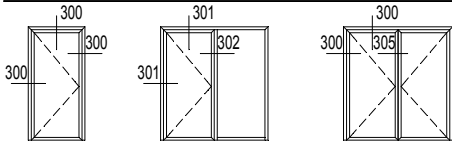

CS59-300001.dxf  
 CS59-300001.dwg

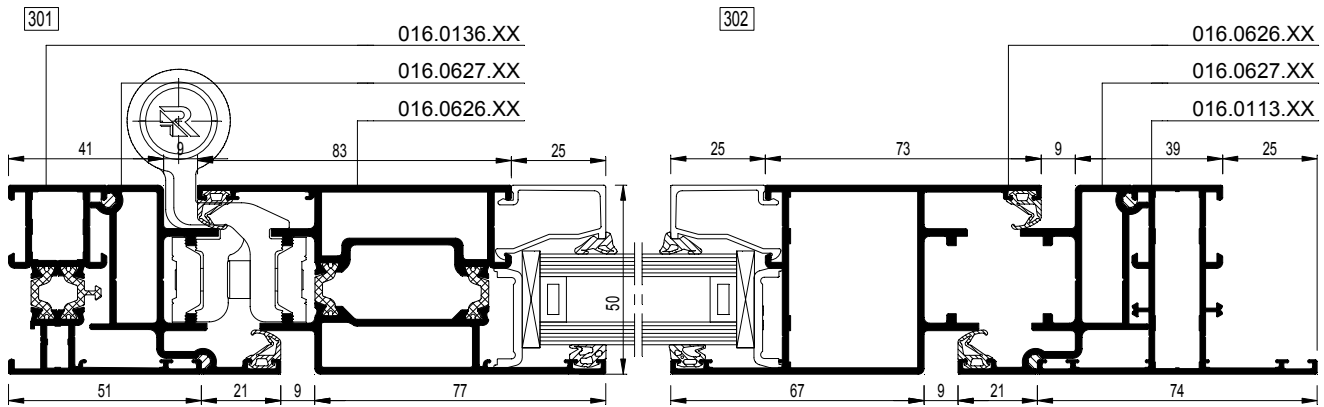

CS59-301001.dxf  
 CS59-301001.dwg

CS59-302001.dxf  
 CS59-302001.dwg

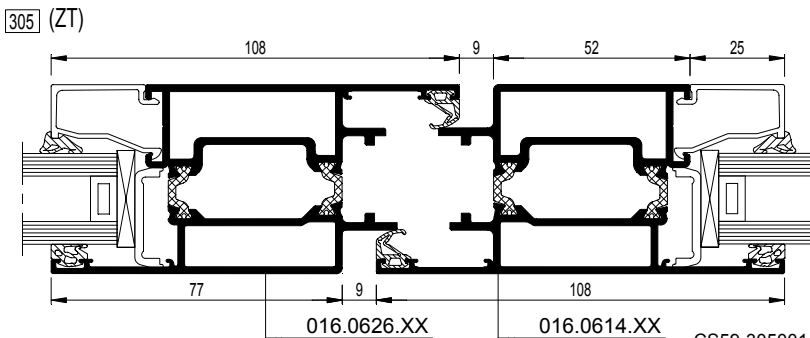

CS59-305001.dxf  
 CS59-305001.dwg

# CS 59Pa-CD

Deuren naar binnen draaiend - Vleugel rondom geperst  
 Portes ouvrant vers l'intérieur - Ouvrant serti tout autour  
 Doors inward opening - Vent crimped all round  
 Türen nach innen öffnend - Rundherum gepresstem Türflügel

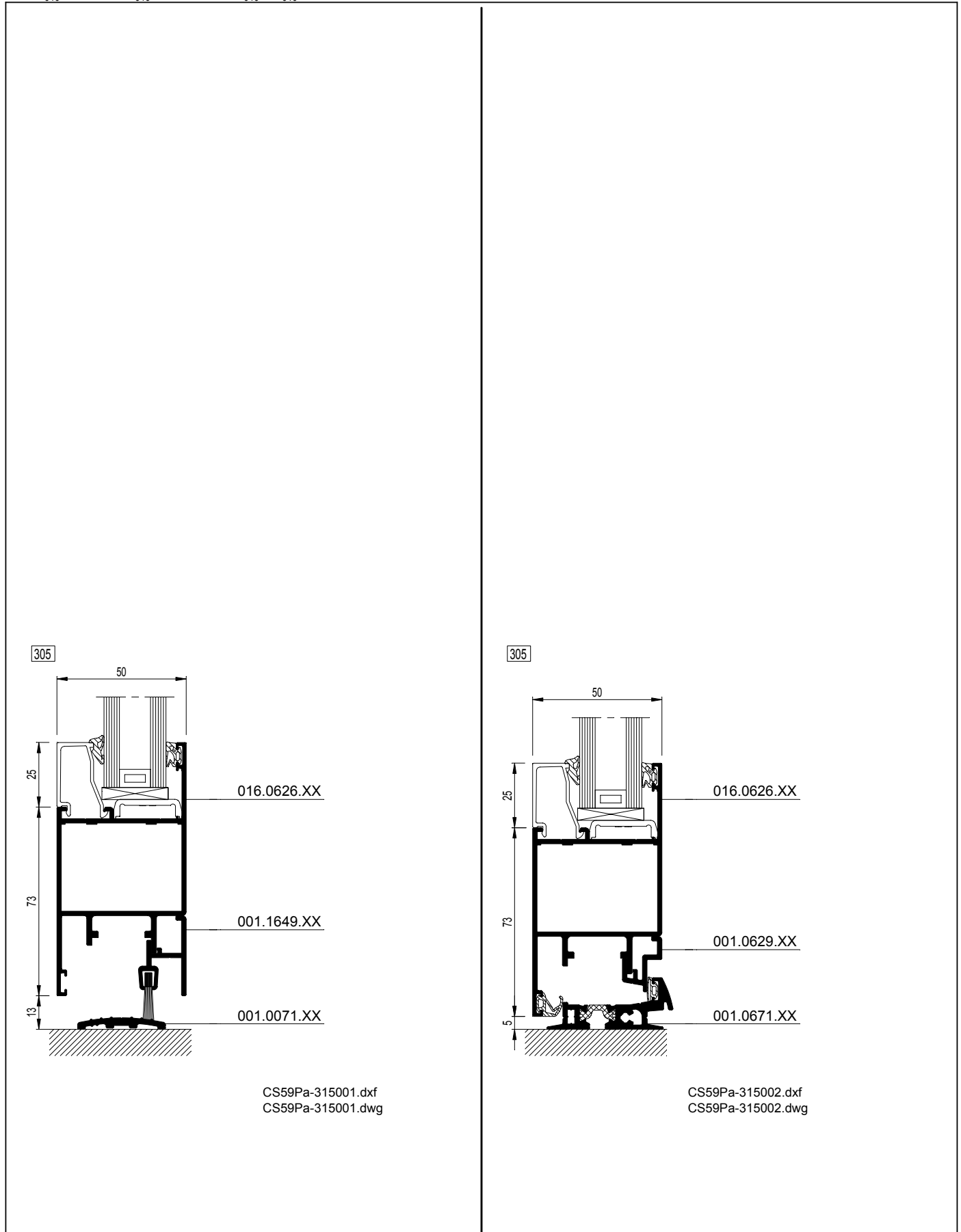
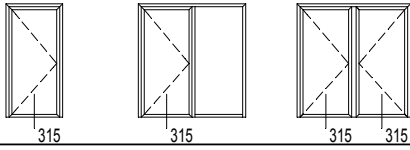

CS59Pa-315001.dxf  
 CS59Pa-315001.dwg

CS59Pa-315002.dxf  
 CS59Pa-315002.dwg

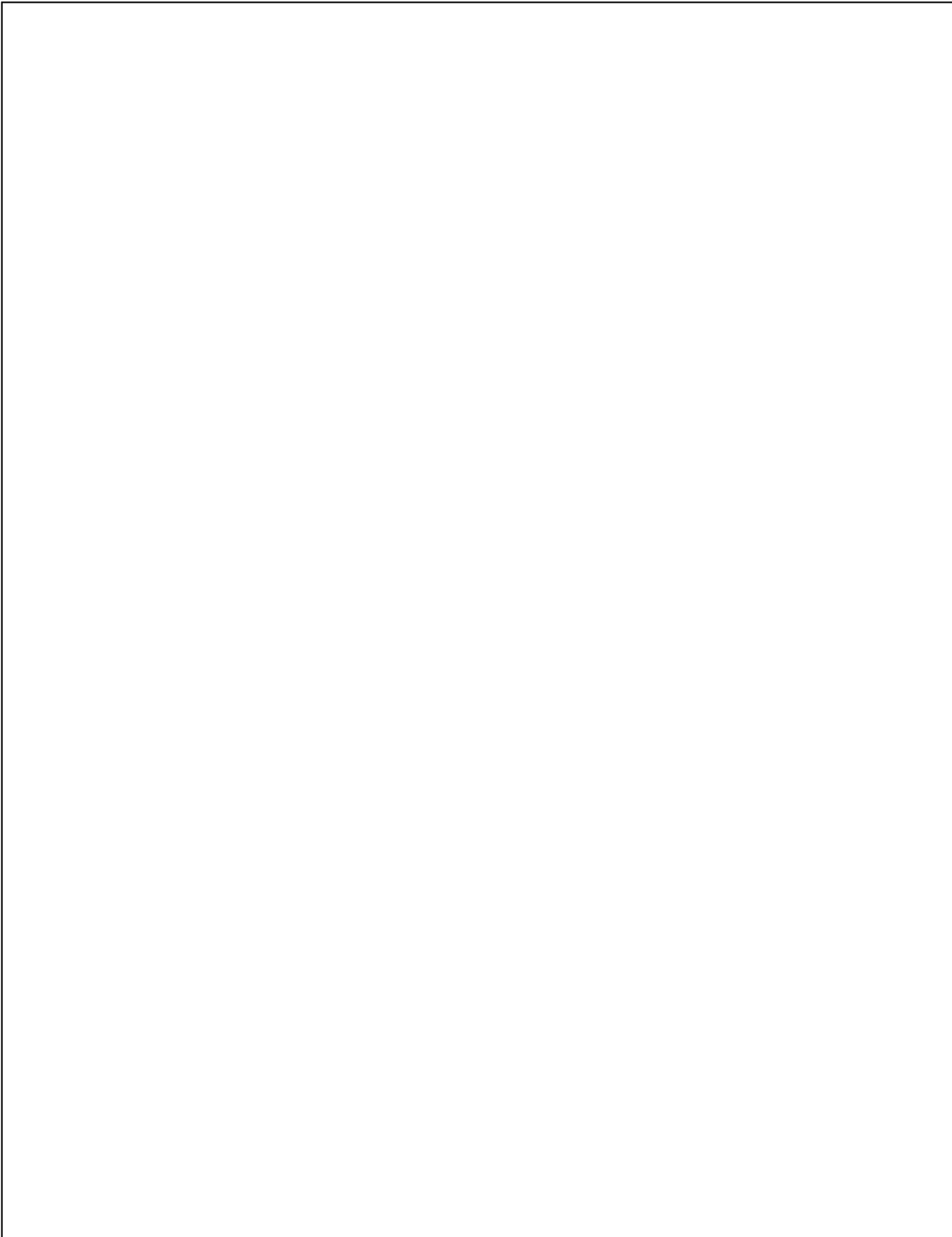



# CS 59Pa-CD

Deuren - Deuren met T-profiel  
Portes - Portes avec traverse  
Doors - Doors with transom-mullion  
Türen - Türen mit T-Profilsockel

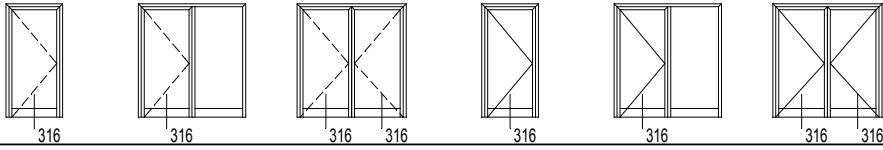

305

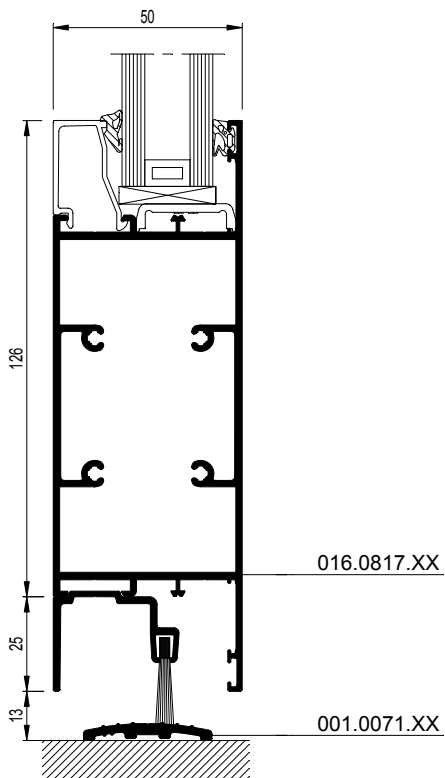

CS59Pa-316001.dxf  
CS59Pa-316001.dwg

# CS 59Pa-CD

Deuren naar buiten draaiend - Naar buiten opengaande deuren  
 Portes ouvrant vers l'extérieur - Portes ouvrant vers l'extérieur  
 Doors outward opening - Outward opening doors  
 Türen nach außen öffnend - Nach außen öffnende Türen

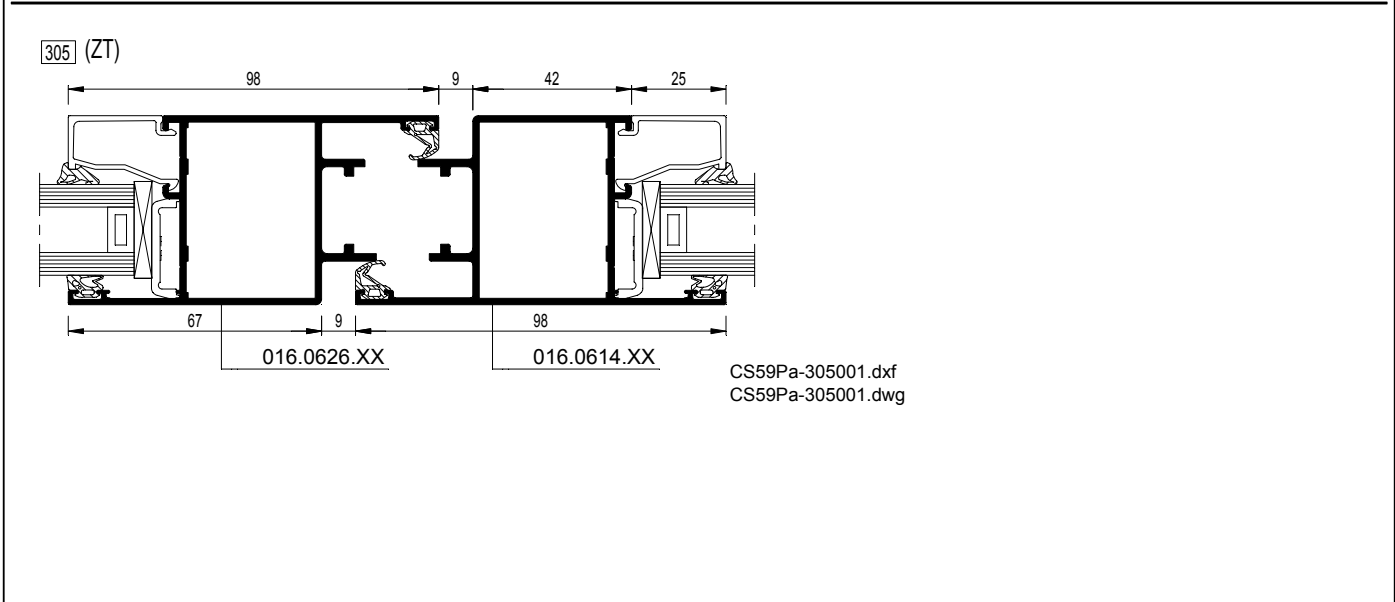
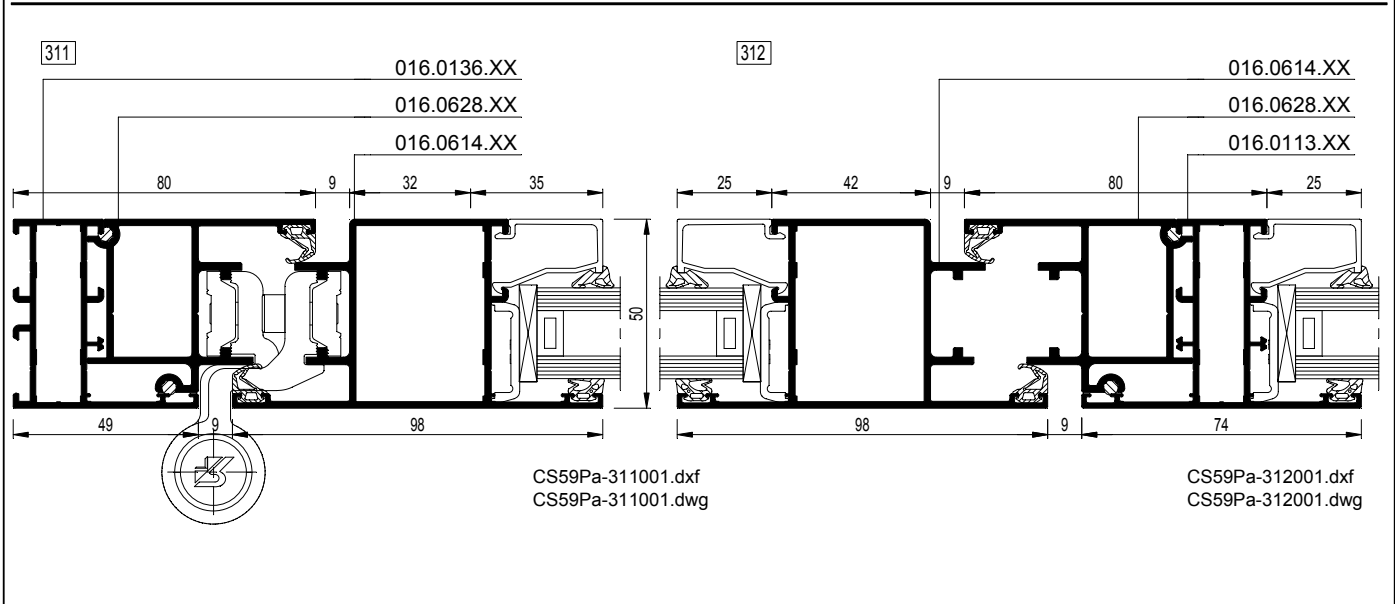
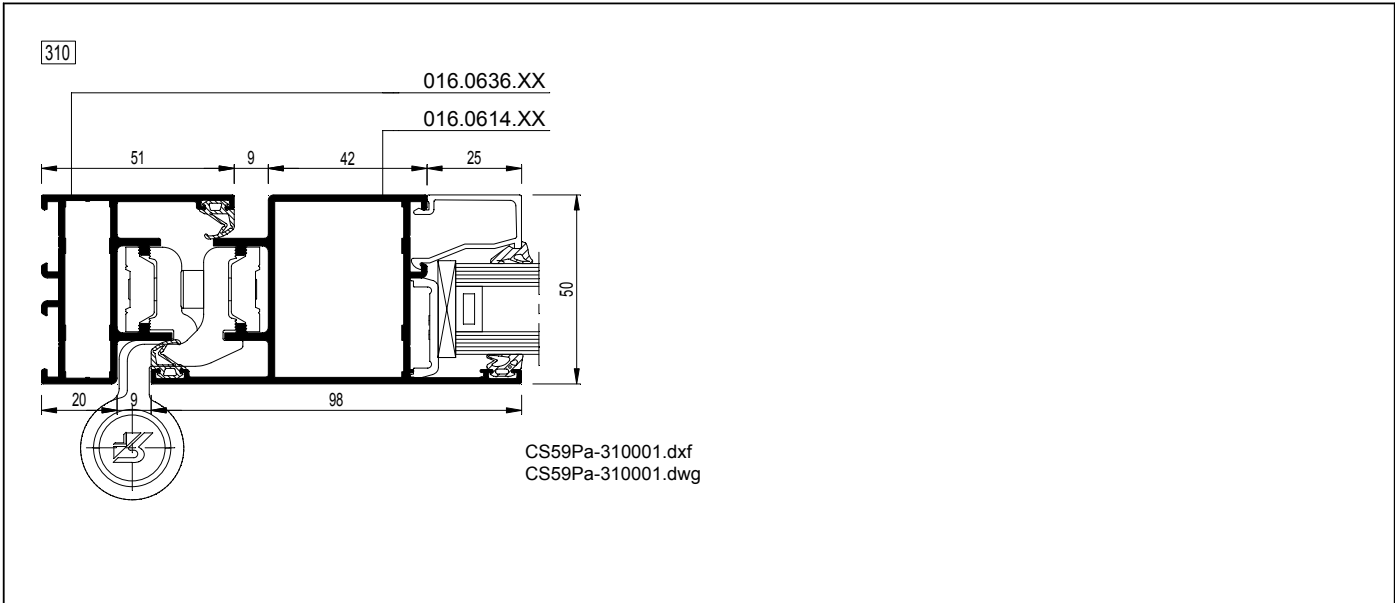
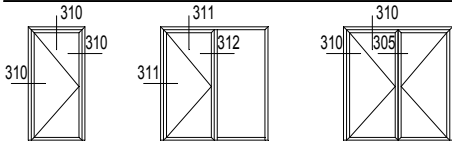

# CS 59Pa-CD

Deuren naar buiten draaiend - Vleugel rondom geperst  
 Portes ouvrant vers l'extérieur - Ouvrant serti tout autour  
 Doors outward opening - Vent crimped all round  
 Türen nach außen öffnend - Rundherum gepresstem Türflügel

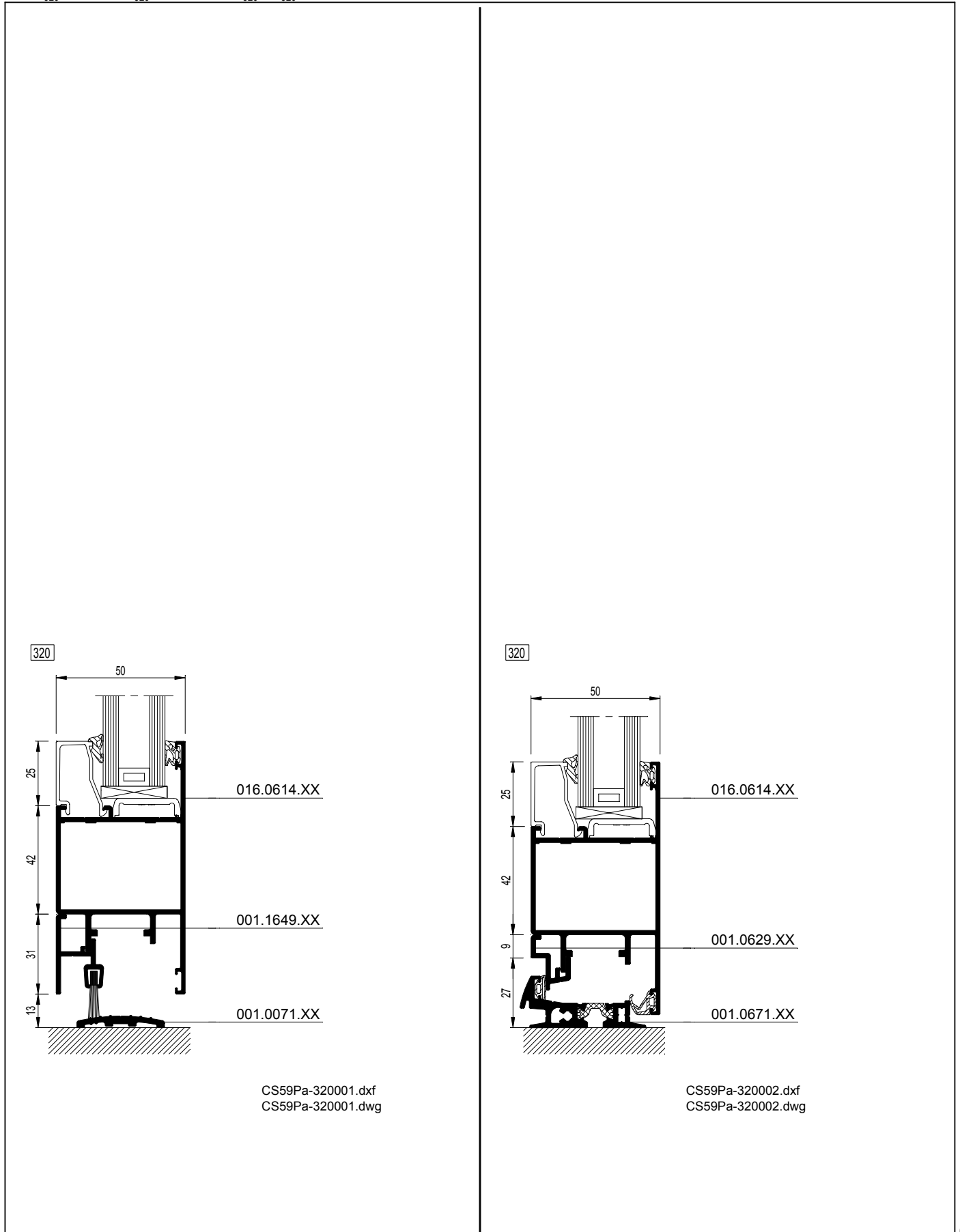
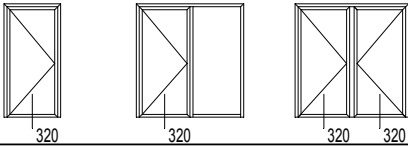

CS59Pa-320001.dxf  
 CS59Pa-320001.dwg

CS59Pa-320002.dxf  
 CS59Pa-320002.dwg

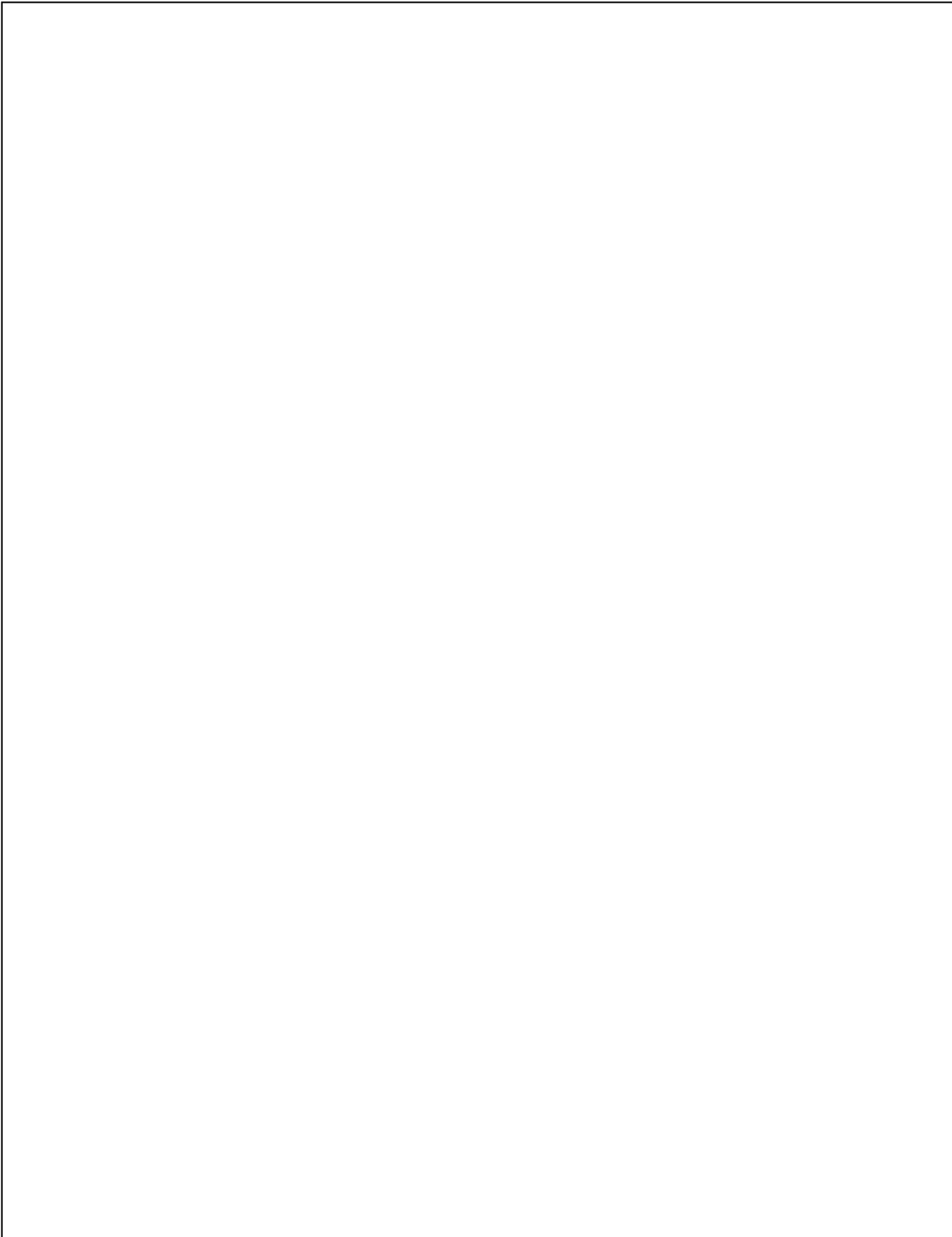



### Koppelingen met andere systemen

TP 110  
TLS 110  
CP 155  
TR 200

CS 59Pa - CN002  
CS 59Pa - CN002  
CS 59Pa - CN003  
CS 59Pa - CN005

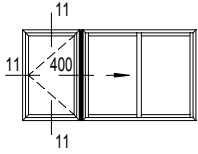

## TP 110

400

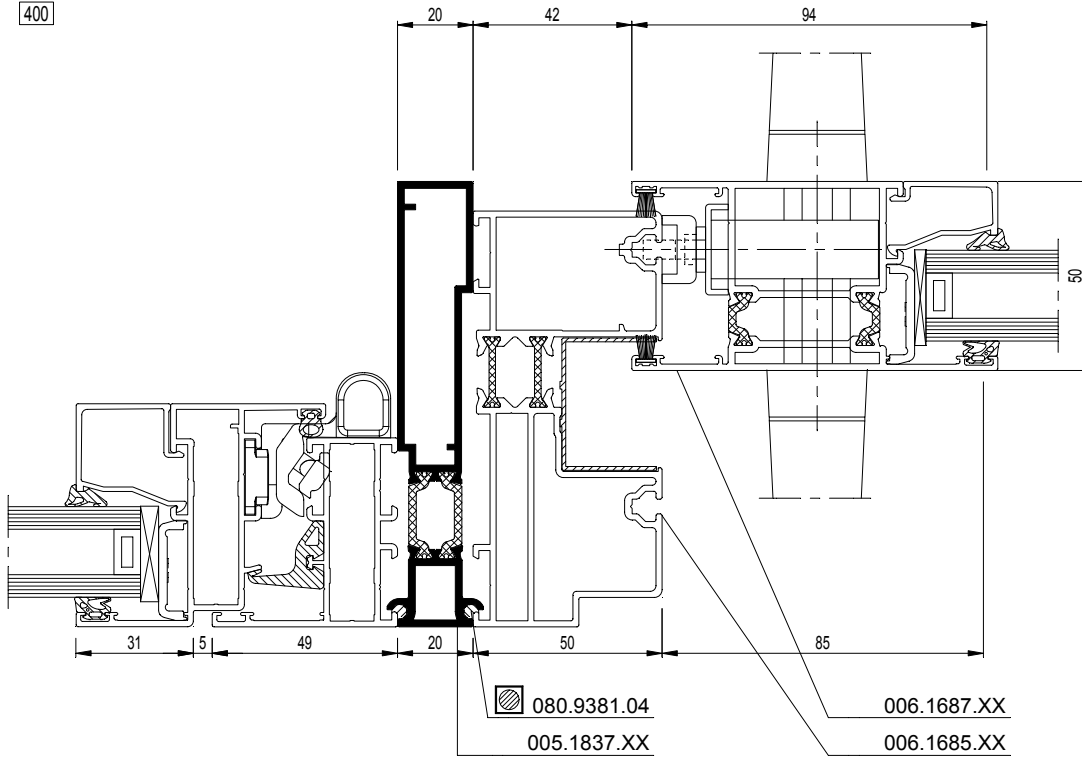

CS59Pa-400001.dxf  
 CS59Pa-400001.dwg

## TLS 110

400

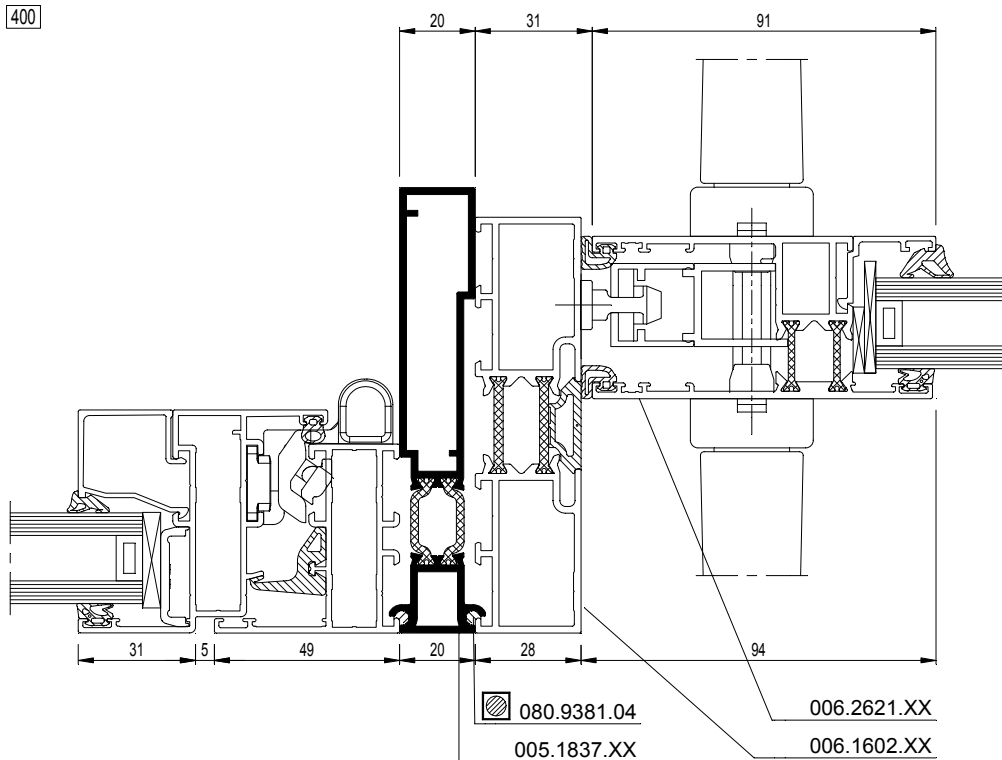

CS59Pa-400002.dxf  
 CS59Pa-400002.dwg

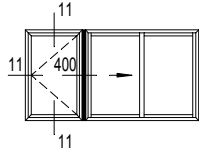

CP 155

400

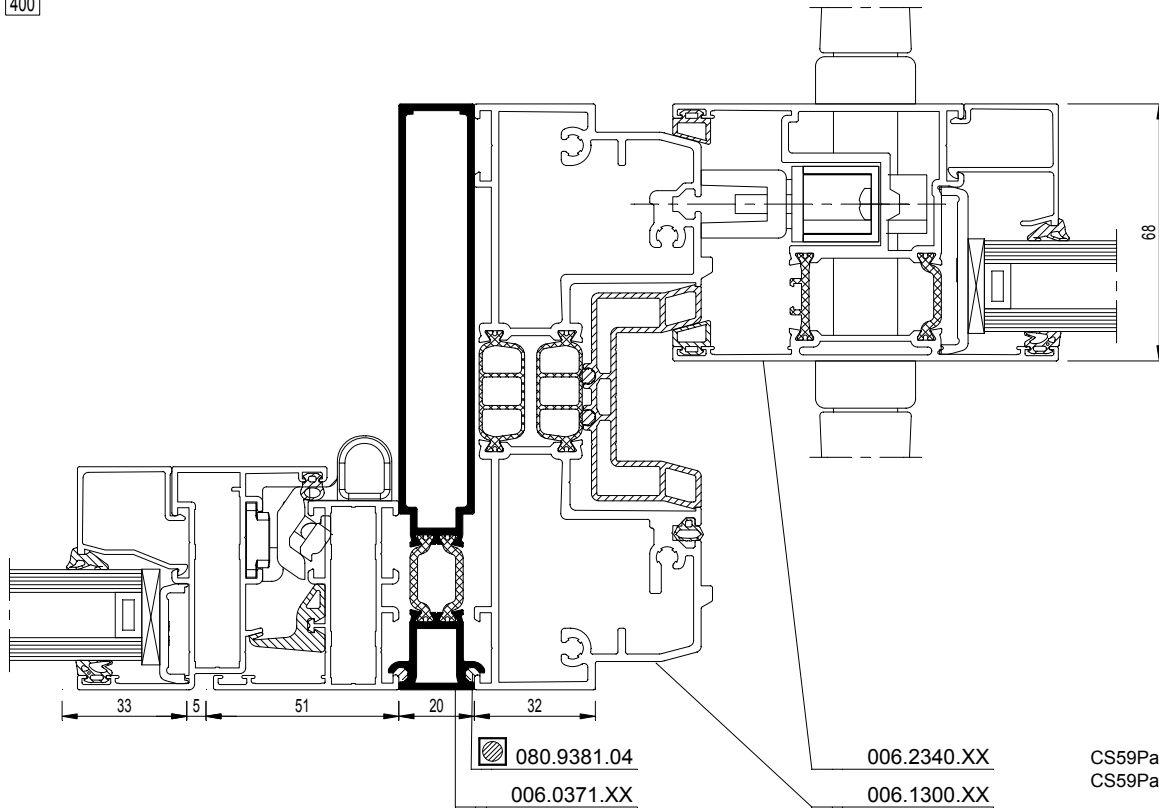

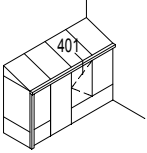

401

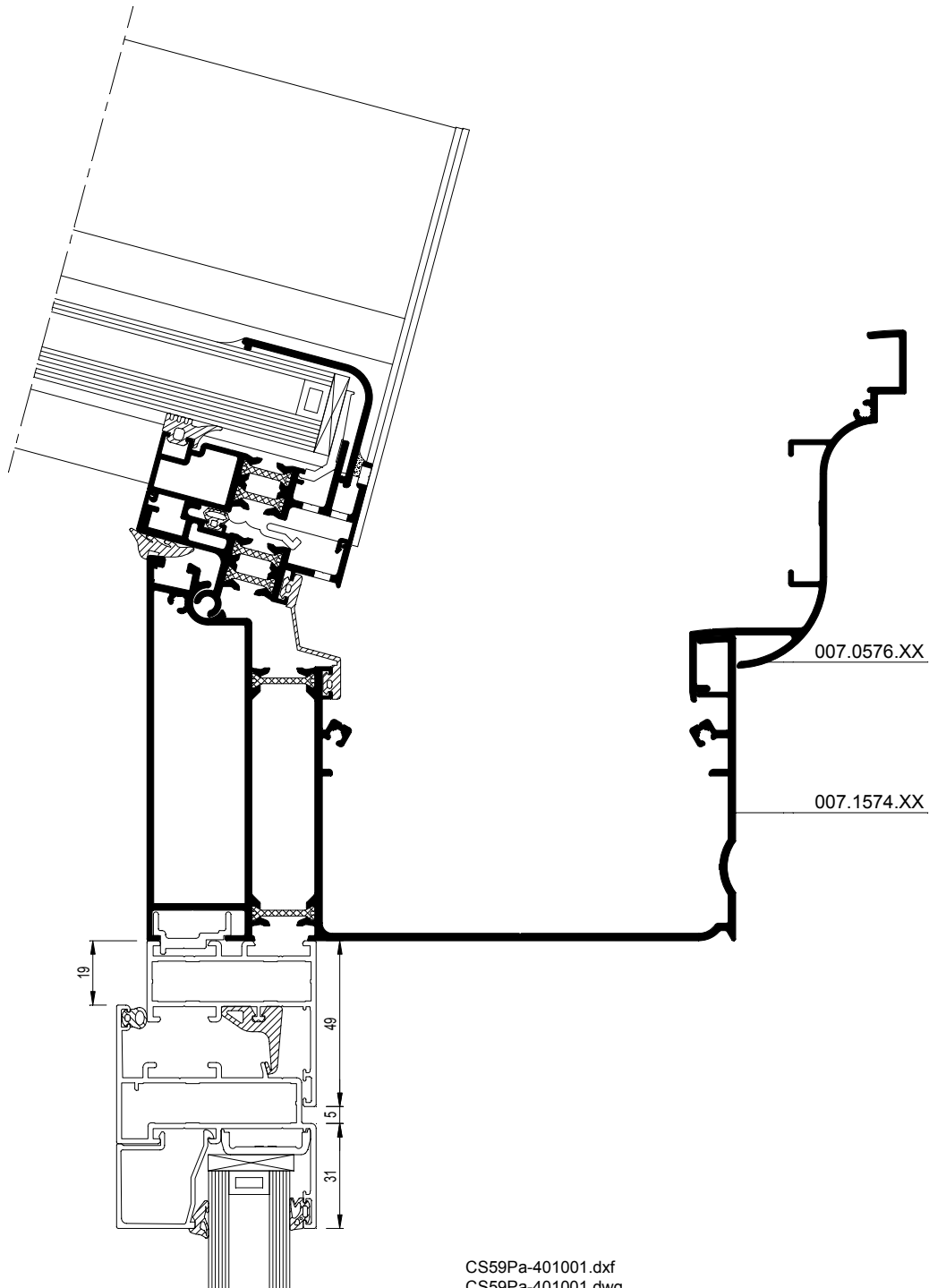

CS59Pa-401001.dxf  
CS59Pa-401001.dwg